



FPF2487 Dual Channel Over-Voltage Protection Load Switch

Features

- Dual Channel Power Switch (V_{BUS} and V_{IF})
- Surge Protection under IEC 61000-4-5
 - V_{BUS} : ± 100 V
 - V_{IF} : ± 40 V
- Input Voltage Range
 - V_{BUS} : 2.5 V ~ 23 V
 - V_{IF} : 3.1 V ~ 5.5 V
- Max. Continuous Current Capability
 - V_{BUS} : 2.5 A
 - V_{IF} : 6 A
- Ultra Low On-Resistance
 - V_{BUS} : Typ. 33 m Ω
 - V_{IF} : Typ. 11 m Ω
- Over-Voltage Protection
 - V_{BUS} : 5.95 V \pm 50 mV
 - V_{IF} : 5.25 V \pm 250 mV
- LDO Output based V_{BUS_DET} for V_{BUS} Detection
- Active Low Control for V_{BUS} Path
- OTG Functionality on V_{BUS} Path
- Conditional Active High Control for V_{IF} Path
- Reverse-Current Blocking for V_{IF} Path

Applications

- Mobile Handsets and Tablets
- Wearable Devices

Description

The FPF2487 features a 2-channel power switch, which offers surge protection and Over-Voltage Protection (OVP), to protect downstream components and enhancing overall system robustness.

Channel one (V_{BUS}) is an active-low, 28 V/2.5 A rated, power MOSFET switch with an internal clamp supporting ± 100 V surge protection, highly accurate fixed OVP at 5.95 V (± 50 mV), and OTG functionality. Channel two (V_{IF}) is a conditional active-high, 6 V/6 A rated, power MOSFET switch with an integrated TVS supporting ± 40 V surge protection and fixed OVP at 5.25 V (± 250 mV). V_{IF} also provides Reverse Current Blocking (RCB) during its OFF state to minimize leakage current.

V_{BUS_DET} is paired with always ON LDO to power downstream devices even with V_{BUS} is greater than 2.5 V, even when disabled through the ONB pin. This provides power sequence control or a host controlled configuration in system.

The FPF2487 is available in a 15-bump, 1.6 mm x 2.2 mm Wafer-Level Chip-Scale Package (WLCSFP) with 0.4 mm pitch.

Related Resources

- <http://www.fairchildsemi.com/>

Ordering Information

Part Number	Operating Temperature Range	Top Mark	Package	Packing Method
FPF2487UCX	-40°C – +85°C	GX	15-Ball, 0.4 mm Pitch WLCSFP	Tape & Reel

Application Diagram

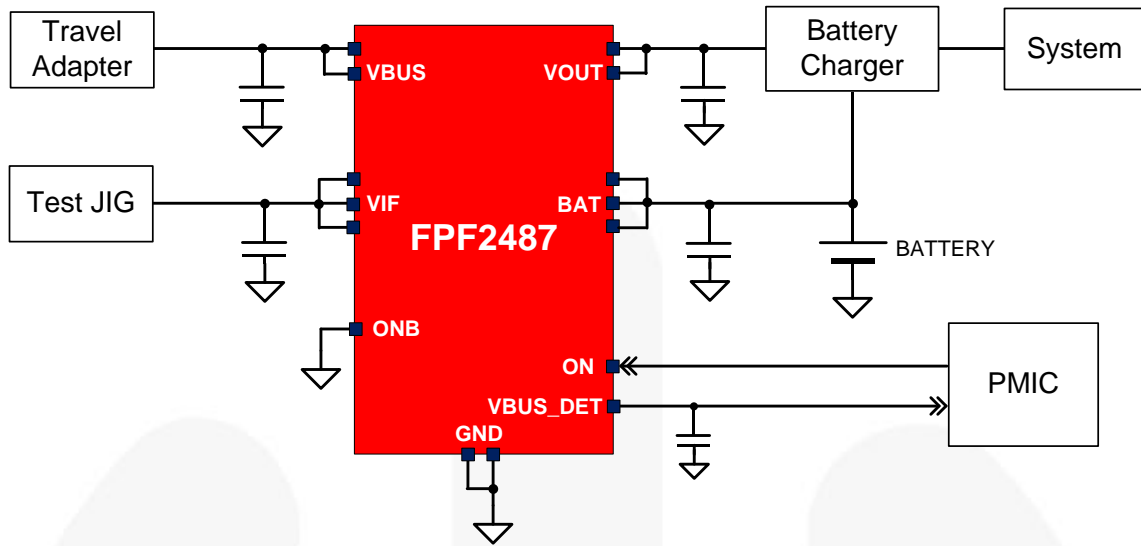

Figure 1. Typical Application

Block Diagram

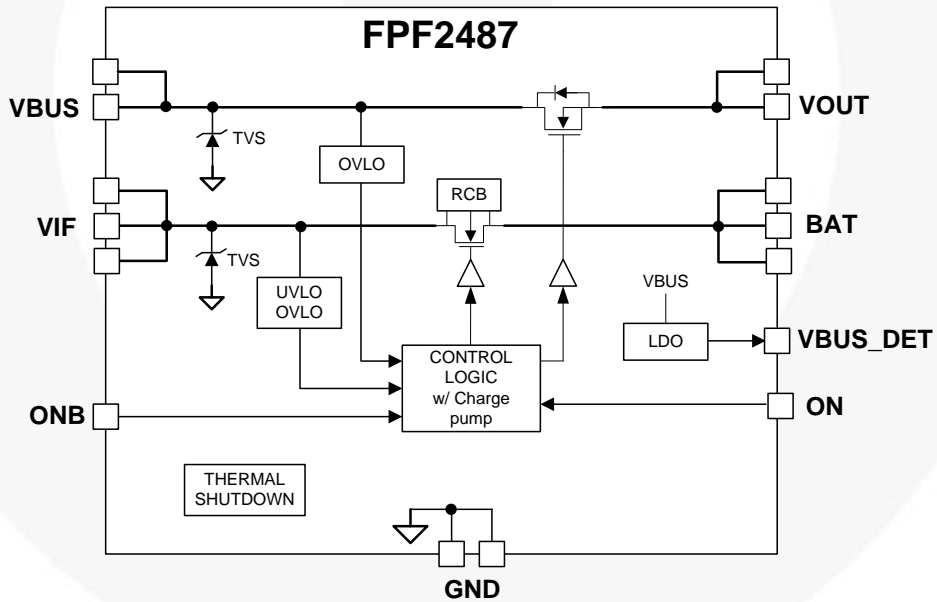

Figure 2. Functional Block Diagram

Pin Configuration

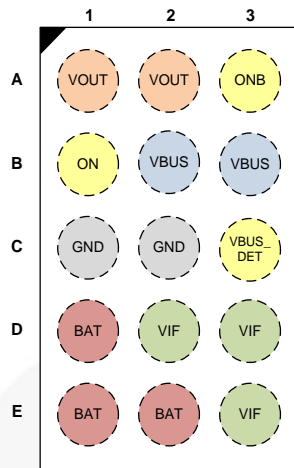

Figure 3. Pin Configuration (Top View)

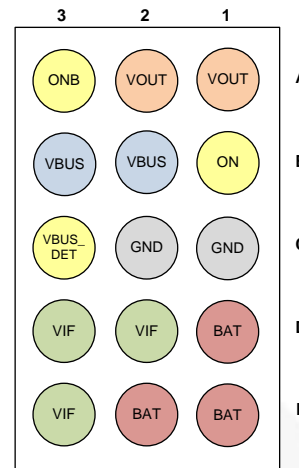

Figure 4. Pin Configuration (Bottom View)

Pin Definitions

Name	Bump	Type	Description
V_{BUS}	B2, B3	Input/Supply	Switch Input and Device Supply
V_{OUT}	A1, A2	Output	Switch Output to Load
V_{IF}	D2, D3, E3	Input/Supply	Switch Input and Device Supply
BAT	D1, E1, E2	Output	Switch Output to Battery
V_{BUS_DET}	C3	Output	Regulated Output according to V_{BUS}
ON	B1	Input	Active HIGH: V_{IF} path only and when BAT is valid prior to V_{IF}
ONB	A3	Input	Active LOW: V_{BUS} path only
GND	C1, C2	GND	Ground

Absolute Maximum Ratings

Stresses exceeding the absolute maximum ratings may damage the device. The device may not function or be operable above the recommended operating conditions and stressing the parts to these levels is not recommended. In addition, extended exposure to stresses above the recommended operating conditions may affect device reliability. The absolute maximum ratings are stress ratings only.

Symbol	Parameter		Min.	Max.	Unit	
V _{BUS}	V _{BUS} to GND & V _{BUS} to V _{OUT} =GND or Float		-0.3	29.0	V	
V _{IF}	V _{IF} to GND		-2 ⁽¹⁾	6	V	
V _{OUT}	V _{OUT} to GND		-0.3	V _{IN} + 0.3	V	
BAT	BAT to GND		-0.3	V _{IF} + 0.3	V	
V _{BUS_DET}	V _{BUS_DET} to GND			8	V	
V _{ON(B)}	ONB or ON to GND			6	V	
I _{IN_VBUS}	Continuous V _{BUS} Current			2.5	A	
	Peak V _{BUS} Current (5 ms)			5	A	
I _{IN_VIF}	Continuous V _{IF} Current			6	A	
	Peak V _{IF} Current (5 ms)			12	A	
I _{IN_VBUS_DET}	Continuous V _{BUS_DET} Current			1	mA	
t _{PD}	Total Power Dissipation at T _A =25°C			1.54	W	
T _{STG}	Storage Temperature Range		-65	+150	°C	
T _J	Maximum Junction Temperature			+150	°C	
T _L	Lead Temperature (Soldering, 10 Seconds)			+260	°C	
θ _{JA}	Thermal Resistance, Junction-to-Ambient ⁽²⁾ (1-in. ² Pad of 2-oz. Copper)			81 ⁽²⁾	°C/W	
ESD	Electrostatic Discharge Capability	IEC 61000-4-2 System Level ESD	Air Discharge	15		kV
			Contact Discharge	8		
		Human Body Model, ANSI/ESDA/JEDEC JS-001-2012	All Pins	2		
		Charged Device Model, JESD22-C101	All Pins	1		
Surge		IEC 61000-4-5, Surge Protection	V _{BUS}	±100		V
			V _{IF}	±40		

Notes:

1. Pulsed, 50 ms maximum non-repetitive.
2. Measured using 2S2P JEDEC std. PCB.

Recommended Operating Conditions

The Recommended Operating Conditions table defines the conditions for actual device operation. Recommended operating conditions are specified to ensure optimal performance to the datasheet specifications. Fairchild does not recommend exceeding them or designing to Absolute Maximum Ratings.

Symbol	Parameter	Min.	Max.	Unit
V _{BUS}	Supply Voltage, V _{BUS}	2.5	23.0	V
V _{IF}	Supply Voltage, V _{IF}	3.1	5.5	V
C _{IN} / C _{OUT}	Input and Output Capacitance	0.1		µF
C _{VBUS_DET}	Output Capacitance	0.47		µF
T _A	Operating Temperature	-40	+85	°C

Electrical Characteristics

Unless otherwise noted, $V_{BUS}=2.5$ to 23 V, $V_{IF}=3.1$ to 5.5 V, $T_A=-40$ to 85°C ; Typical values are at $V_{BUS}=5$ V, $I_{IN} \leq 2$ A, $V_{IF}=4$ V, $C_{IN}=0.1$ μF and $T_A=25^\circ\text{C}$.

Symbol	Parameter	Conditions	Min.	Typ.	Max.	Unit
Basic Operation						
I_Q	Input Quiescent Current	$V_{BUS}=5$ V, $ONB=0$ V, $V_{BUS_DET}=\text{Floating}$		160	250	μA
		$V_{IF}=4$ V		100	150	μA
I_{IN_Q}	OVLO Supply Current	$V_{BUS}=12$ V, $V_{OUT}=0$ V, $V_{BUS_DET}=\text{Floating}$		150	205	μA
		$V_{IF}=5.5$ V, $BAT=0$ V		100	180	μA
T_{SDN}	Thermal Shutdown ⁽³⁾			140		$^\circ\text{C}$
T_{SDN_HYS}	Thermal Shutdown Hysteresis ⁽³⁾			20		$^\circ\text{C}$
V_{BUS} to V_{OUT} Switch						
V_{BUS_CLAMP}	Input Clamping Voltage	$I_{IN}=10$ mA		35		V
V_{BUS_OVLO}	Over-Voltage Trip Level	V_{BUS} Rising, $T_A=-40$ to 85°C	5.90	5.95	6.00	V
		V_{BUS} Falling, $T_A=-40$ to 85°C	5.8			V
R_{ON_VBUS}	On-Resistance	$V_{BUS}=5$ V, $I_{OUT}=1$ A, $T_A=25^\circ\text{C}$		33	39	m Ω
		$V_{BUS}=9$ V, $I_{OUT}=1$ A, $T_A=25^\circ\text{C}$		33	39	m Ω
t_{DEB_VBUS}	Debounce Time	Time from $V_{BUS_MIN} < V_{BUS} < V_{BUS_OVLO}$ to $V_{OUT}=0.1 \times V_{BUS}$		15		ms
t_{START_VBUS}	Soft-Start Time	Time from $V_{BUS}=V_{BUS_MIN}$ to $0.1 \times V_{BUS_DET}$		30		ms
t_{ON_VBUS}	Switch Turn-On Time	$R_L=100$ Ω , $C_L=22$ μF , V_{OUT} from $0.1 \times V_{BUS}$ to $0.9 \times V_{BUS}$		3		ms
t_{OFF_VBUS}	Switch Turn-Off Time	$R_L=100$ Ω , No C_L , $V_{BUS} > V_{BUS_OVLO}$ to $V_{OUT}=0.8 \times V_{BUS}$			150	ns
V_{IF} to BAT Switch						
V_{IF_CLAMP}	Input Clamping Voltage	$I_{IN}=10$ mA		6.4		V
V_{IF_UVLO}	Under-Voltage Trip Level	V_{IF} Rising, $T_A=-40$ to 85°C		2.85	3.05	V
		V_{IF} Falling, $T_A=-40$ to 85°C		2.7		V
V_{IF_OVLO}	Over-Voltage Trip Level	V_{IF} Rising, $T_A=-40$ to 85°C	5.00	5.25	5.50	V
		V_{IF} Falling, $T_A=-40$ to 85°C	4.8			V
R_{ON_VIF}	On-Resistance	$V_{IF}=3.1$ V, $I_{OUT}=1$ A, $T_A=25^\circ\text{C}$		10	15	m Ω
I_{RCB}	Reverse Current	$V_{IF}=0$ V, $BAT=4.4$ V		3	7	μA
t_{DEB_VIF}	Debounce Time	Time from $V_{IF_UVLO} < V_{IF} < V_{IF_OVLO}$ to $BAT=0.1 \times V_{IF}$		15		ms
t_{QUAL_VIF}	Qualification Tim	$BAT > V_{IH_BAT}$ First, Time from ON $> V_{IH_ON(B)}$ to BAT Voltage Increase		2		ms
t_{ON_VIF}	Switch Turn-On Time	$R_L=100$ Ω , $C_L=22$ μF , V_{OUT} from $0.1 \times V_{IF}$ to $0.9 \times V_{IF}$		2		ms
t_{OFF_VIF}	Switch Turn-Off Time	$R_L=100$ Ω , No C_L , $V_{IN} > V_{OVLO}$ to $V_{OUT}=0.8 \times V_{IF}$			150	ns

Note:

3. Guaranteed by characterization and design.

Continued on the following page...

Electrical Characteristics (Continued)

Unless otherwise noted, $V_{BUS}=2.5$ to 23 V, $V_{IF}=3.1$ to 5.5 V, $T_A=-40$ to 85°C ; Typical values are at $V_{BUS}=5$ V, $I_{IN} \leq 2$ A, $V_{IF}=4$ V, $C_{IN}=0.1$ μF and $T_A=25^\circ\text{C}$.

Symbol	Parameter	Conditions	Min.	Typ.	Max.	Unit
V_{BUS_DET}						
V _{BUS_DET}	V _{BUS_DET} Output Voltage	V _{BUS} =6.5 V, I _{BUS_DET} =0 mA, T _A =25°C	6.0		6.5	V
		V _{BUS} =15 V, I _{BUS_DET} =0 mA, T _A =25°C	6.0	7.0	7.9	V
		V _{BUS} =6.5 V, I _{BUS_DET} =1 mA, T _A =25°C	6.0	6.3	6.5	V
		V _{BUS} =15 V, I _{BUS_DET} =1 mA, T _A =25°C	6.0	7.0	7.9	V
Digital Signals						
V _{IH_ON(B)}	Enable HIGH Voltage	V _{BUS} , V _{IF} Operating Range	1.2			V
V _{IL_ON(B)}	Enable LOW Voltage	V _{BUS} , V _{IF} Operating Range			0.5	V
V _{IH_BAT}	BAT Presence HIGH Voltage	BAT Rising	2.5			V
V _{IL_BAT}	BAT Presence LOW Voltage	BAT Falling			1.7	V
I _{VBUS_DET_LEAK}	V _{BUS_DET} Leakage Current	V _{VBUS_DET} =5 V, V _{BUS} =0 V			1	μA
ON(B)_Leak	ON(B) Leakage Current	V _{BUS} =5 V, V _{OUT} =Float			1	μA

Timing Diagrams

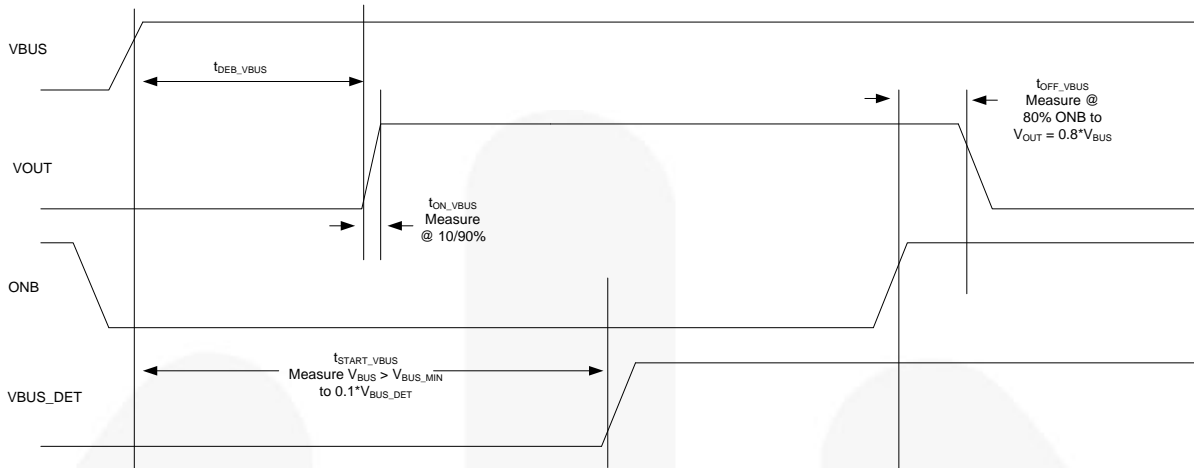

Figure 5. Timing for V_{BUS} Power Up/Down and Normal Operation

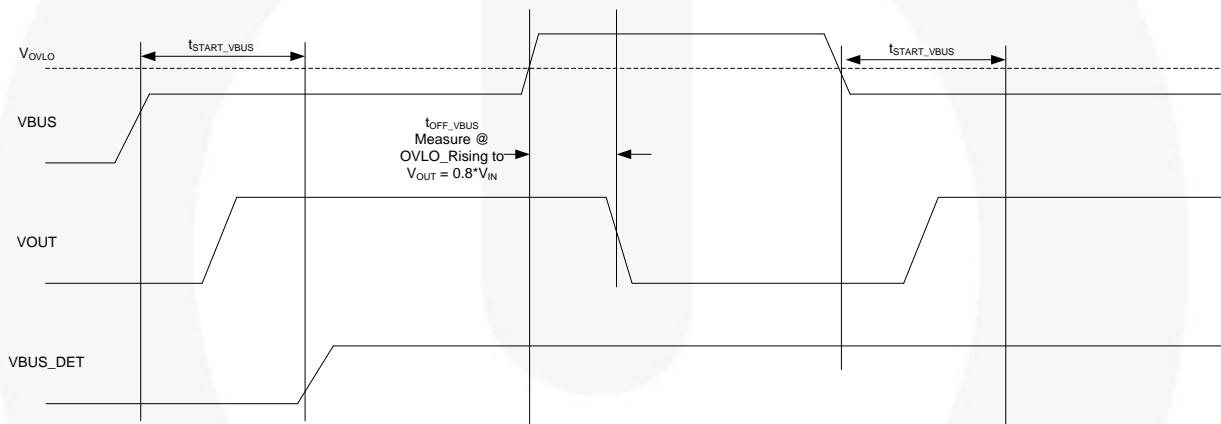

Figure 6. Timing for V_{BUS} OVLO Operation (ONB=LOW)

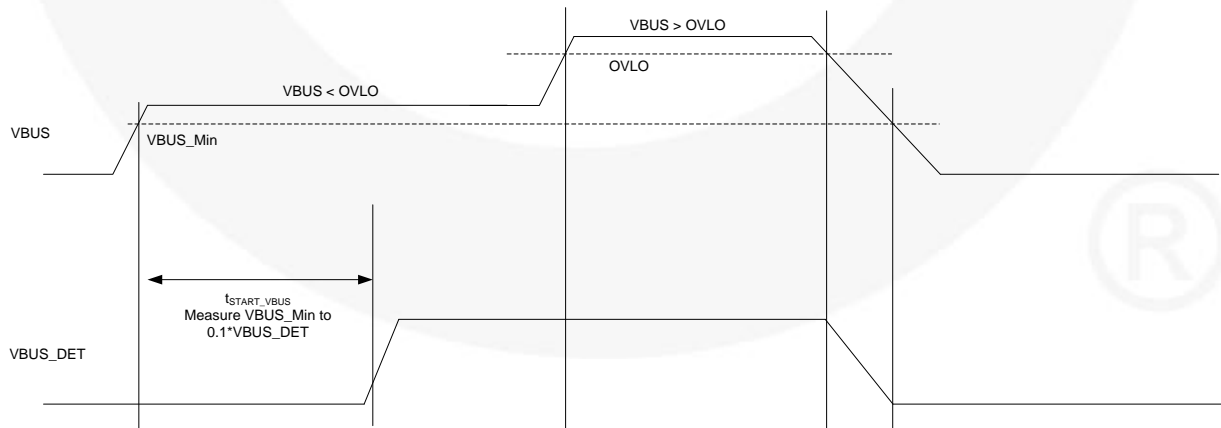

Figure 7. Always ON V_{BUS_DET} Operation (ONB=HIGH)

Timing Diagrams (Continued)



Figure 8. Timing for V_{IF} Power Up/Down and Normal Operation (ON=Don't Care)

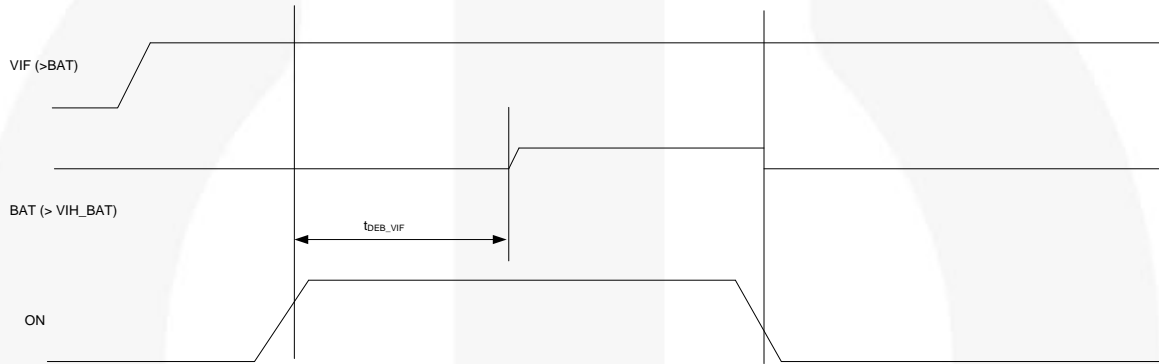

Figure 9. Timing for V_{IF} Power Up/Down and Normal Operation with ON Pin

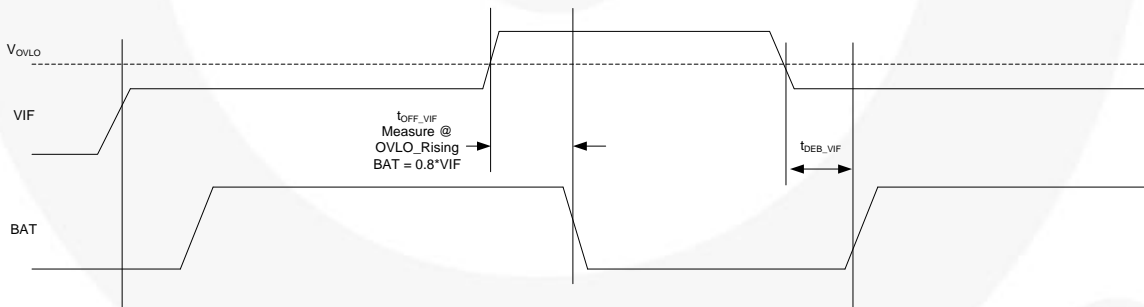

Figure 10. Timing for V_{IF} OVLO Operation (ON=Don't Care)

V_{IF} Turn-On Qualification State Diagram

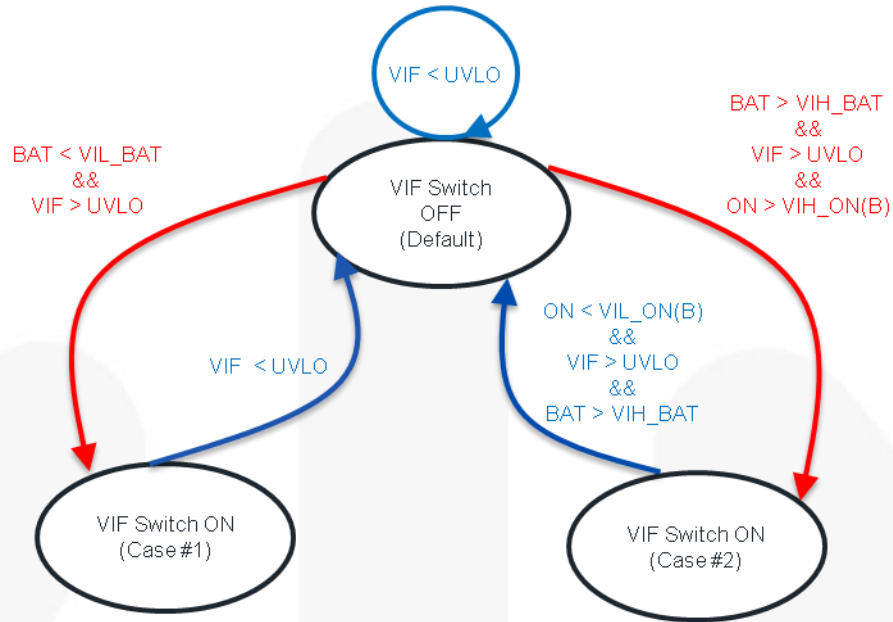

Figure 11. V_{IF} Turn-On Qualification State Diagram

Notes:

- 4. Case #1 is reflecting removable battery system without ON signal.
- 5. Case #2 is reflecting embedded battery system with ON signal.

Product-Specific Package Dimensions

D	E	X	Y
2200 μm ±30 μm	1600 μm ±30 μm	400 μm ±18 μm	300 μm ±18 μm

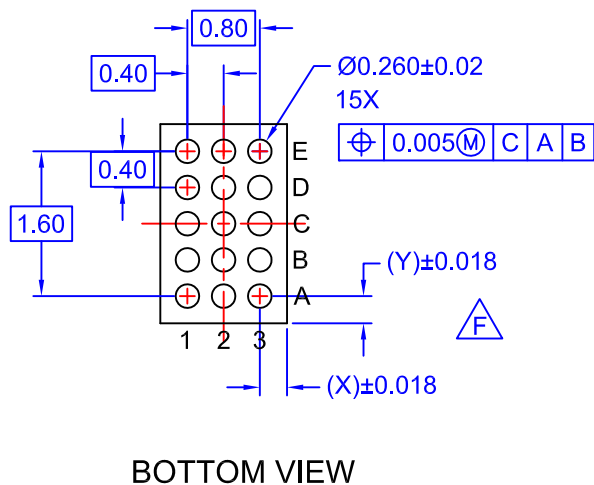
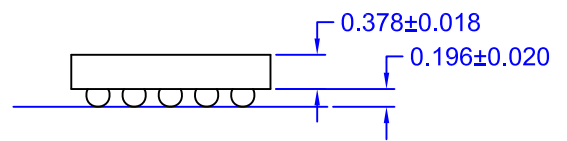
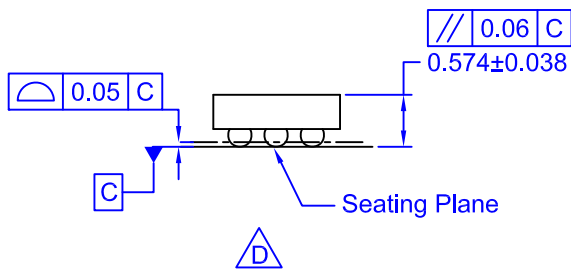
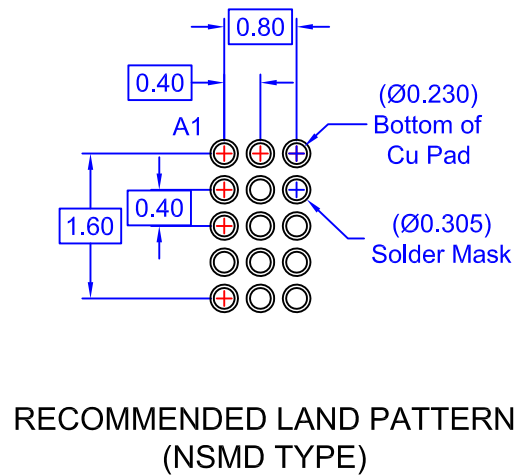
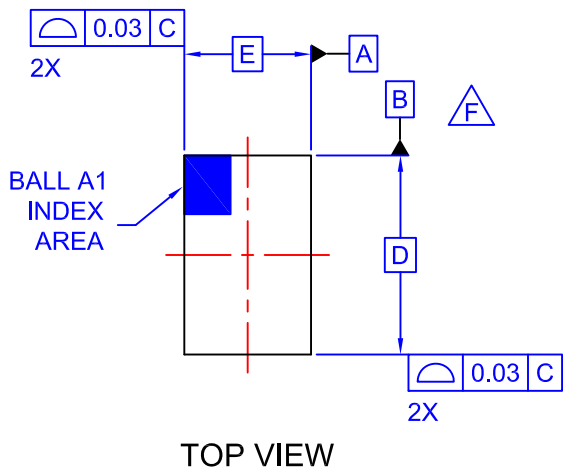





NOTES

- A. NO JEDEC REGISTRATION APPLIES.
- B. DIMENSIONS ARE IN MILLIMETERS.
- C. DIMENSIONS AND TOLERANCE PER ASMEY14.5M, 2009.
- D.** DATUM C IS DEFINED BY THE SPHERICAL CROWNS OF THE BALLS.
- E.** PACKAGE NOMINAL HEIGHT IS 574 ± 38 MICRONS (536-612 MICRONS).
- F.** FOR DIMENSIONS D, E, X, AND Y SEE PRODUCT DATASHEET.
- G. DRAWING FILNAME: MKT-UC015AC REV2.



TRADEMARKS

The following includes registered and unregistered trademarks and service marks, owned by Fairchild Semiconductor and/or its global subsidiaries, and is not intended to be an exhaustive list of all such trademarks.

- | | | | |
|---|--|---|---|
| AccuPower™ | F-PFS™ | OPTOPLANAR® |  |
| AttitudeEngine™ | FRFET® |  | TinyBoost® |
| Awinda® | Global Power Resource SM | Power Supply WebDesigner™ | TinyBuck® |
| AX-CAP®* | GreenBridge™ | PowerTrench® | TinyCalc™ |
| BitSiC™ | Green FPS™ | PowerXS™ | TinyLogic® |
| Build it Now™ | Green FPS™ e-Series™ | Programmable Active Droop™ | TINYOPTO™ |
| CorePLUS™ | Gmax™ | QFET® | TinyPower™ |
| CorePOWER™ | GTO™ | QS™ | TinyPWM™ |
| CROSSVOL™ | IntelliMAX™ | Quiet Series™ | TinyWire™ |
| CTL™ | ISOPLANAR™ | RapidConfigure™ | TranSiC™ |
| Current Transfer Logic™ | Making Small Speakers Sound Louder and Better™ |  | TriFault Detect™ |
| DEUXPEED® | MegaBuck™ | Saving our world, 1mW/W/kW at a time™ | TRUECURRENT®* |
| Dual Cool™ | MICROCOUPLER™ | SignalWise™ | μSerDes™ |
| EcoSPARK® | MicroFET™ | SmartMax™ |  |
| EfficientMax™ | MicroPak™ | SMART START™ | UHC® |
| ESBC™ | MicroPak2™ | Solutions for Your Success™ | Ultra FRFET™ |
|  | MillerDrive™ | SPM® | UniFET™ |
| Fairchild® | MotionMax™ | STEALTH™ | VCX™ |
| Fairchild Semiconductor® | MotionGrid® | SuperFET® | VisualMax™ |
| FACT Quiet Series™ | MTi® | SuperSOT™-3 | VoltagePlus™ |
| FACT® | MTx® | SuperSOT™-6 | XS™ |
| FastvCore™ | MVN® | SuperSOT™-8 | Xsens™ |
| FETBench™ | mWSaver® | SupreMOS® | 仙童® |
| FPS™ | OptoHiT™ | SyncFET™ | |
| | OPTOLOGIC® | Sync-Lock™ | |

* Trademarks of System General Corporation, used under license by Fairchild Semiconductor.

DISCLAIMER

FAIRCHILD SEMICONDUCTOR RESERVES THE RIGHT TO MAKE CHANGES WITHOUT FURTHER NOTICE TO ANY PRODUCTS HEREIN TO IMPROVE RELIABILITY, FUNCTION, OR DESIGN. TO OBTAIN THE LATEST, MOST UP-TO-DATE DATASHEET AND PRODUCT INFORMATION, VISIT OUR WEBSITE AT [HTTP://WWW.FAIRCHILDSEMI.COM](http://www.fairchildsemi.com). FAIRCHILD DOES NOT ASSUME ANY LIABILITY ARISING OUT OF THE APPLICATION OR USE OF ANY PRODUCT OR CIRCUIT DESCRIBED HEREIN; NEITHER DOES IT CONVEY ANY LICENSE UNDER ITS PATENT RIGHTS, NOR THE RIGHTS OF OTHERS. THESE SPECIFICATIONS DO NOT EXPAND THE TERMS OF FAIRCHILD'S WORLDWIDE TERMS AND CONDITIONS, SPECIFICALLY THE WARRANTY THEREIN, WHICH COVERS THESE PRODUCTS.

AUTHORIZED USE

Unless otherwise specified in this data sheet, this product is a standard commercial product and is not intended for use in applications that require extraordinary levels of quality and reliability. This product may not be used in the following applications, unless specifically approved in writing by a Fairchild officer: (1) automotive or other transportation, (2) military/aerospace, (3) any safety critical application – including life critical medical equipment – where the failure of the Fairchild product reasonably would be expected to result in personal injury, death or property damage. Customer's use of this product is subject to agreement of this Authorized Use policy. In the event of an unauthorized use of Fairchild's product, Fairchild accepts no liability in the event of product failure. In other respects, this product shall be subject to Fairchild's Worldwide Terms and Conditions of Sale, unless a separate agreement has been signed by both Parties.

ANTI-COUNTERFEITING POLICY

Fairchild Semiconductor Corporation's Anti-Counterfeiting Policy. Fairchild's Anti-Counterfeiting Policy is also stated on our external website, www.fairchildsemi.com, under Terms of Use

Counterfeiting of semiconductor parts is a growing problem in the industry. All manufacturers of semiconductor products are experiencing counterfeiting of their parts. Customers who inadvertently purchase counterfeit parts experience many problems such as loss of brand reputation, substandard performance, failed applications, and increased cost of production and manufacturing delays. Fairchild is taking strong measures to protect ourselves and our customers from the proliferation of counterfeit parts. Fairchild strongly encourages customers to purchase Fairchild parts either directly from Fairchild or from Authorized Fairchild Distributors who are listed by country on our web page cited above. Products customers buy either from Fairchild directly or from Authorized Fairchild Distributors are genuine parts, have full traceability, meet Fairchild's quality standards for handling and storage and provide access to Fairchild's full range of up-to-date technical and product information. Fairchild and our Authorized Distributors will stand behind all warranties and will appropriately address any warranty issues that may arise. Fairchild will not provide any warranty coverage or other assistance for parts bought from Unauthorized Sources. Fairchild is committed to combat this global problem and encourage our customers to do their part in stopping this practice by buying direct or from authorized distributors.

PRODUCT STATUS DEFINITIONS

Definition of Terms

Datasheet Identification	Product Status	Definition
Advance Information	Formative / In Design	Datasheet contains the design specifications for product development. Specifications may change in any manner without notice.
Preliminary	First Production	Datasheet contains preliminary data; supplementary data will be published at a later date. Fairchild Semiconductor reserves the right to make changes at any time without notice to improve design.
No Identification Needed	Full Production	Datasheet contains final specifications. Fairchild Semiconductor reserves the right to make changes at any time without notice to improve the design.
Obsolete	Not In Production	Datasheet contains specifications on a product that is discontinued by Fairchild Semiconductor. The datasheet is for reference information only.