

FAN7563/FAN7564

Lithium-Ion Charger Controller

Features

- Constant Voltage & Constant Current Control
- Wide Operating Range of 2.5V ~ 16V
- Low-Side Source Return Current Sensing
- Externally Adjustable Charging Current Control
- Charging Current Monitoring
- Precision LDO Regulator Drive Output (Adj)
(Only FAN7564)
- Error signals of Output Dropout (LDO)
(Only FAN7564)
- Current Limit (LDO)
(FAN7564 Only)

Description

The FAN7563/FAN7564 is designed for Lithium-ion battery charger. This controls charging current and voltage of Lithium - ion battery as constant current and constant voltage control IC and can be used for stand alone charger (FAN7563) and micom interface charger(FAN7564). In addition LDO regulator driving output which is integrated within FAN7564 enables to offer accurate reference voltage to power supply of micro controller, therefore, it features increasing stability and efficiency of charger set as well as minimizing external components of the set. Additionally, FAN7563/FAN7564 provide the protection functions like error flag, short circuit protection(LDO), and charging current control disable.

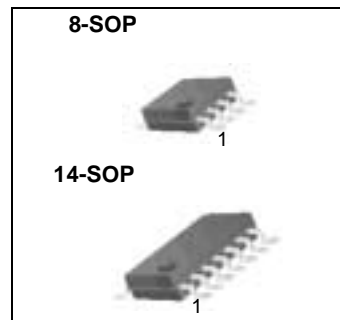

Internal Block Diagram

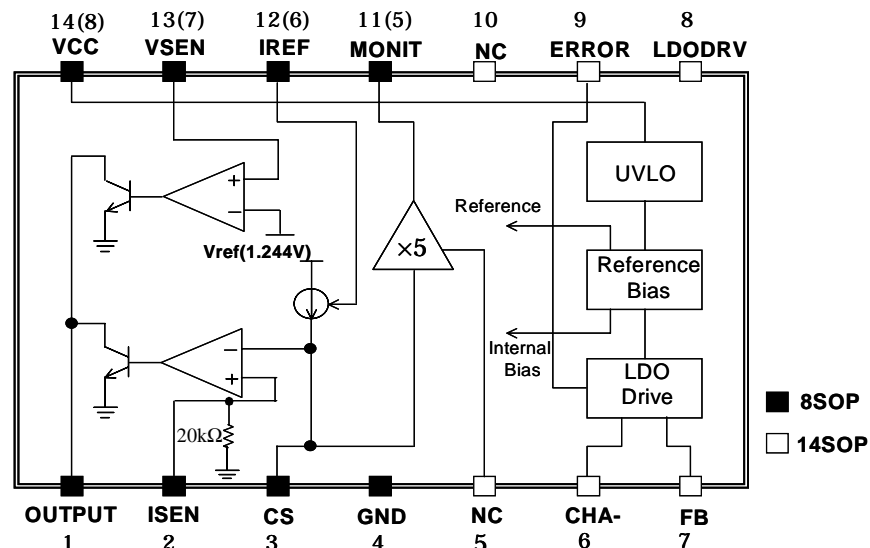

Pin Assignments

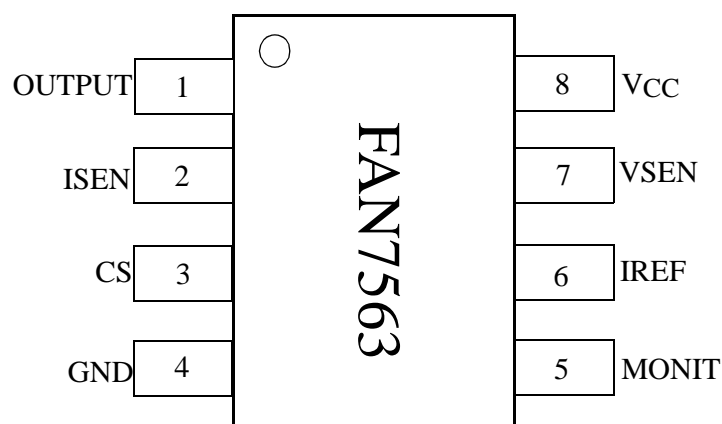

Pin Definitions

Pin Number	Pin Name	Pin Function Description
1	OUTPUT	Output pin for charging control. An external photocoupler is driven from the output for constant voltage and constant current charging control.
2	ISEN	Reference input for current amplifier.
3	CS	Charging current sensing input . It is connected to a sense resistor (system ground)
4	GND	Ground
5	MONIT	Charging current monitoring output. This pin is connected to a micro controller and detects the amplified voltage derived from CS pin.
6	IREF	Reference current control input. The Amplifier reference current is controlled according to the resistor which is connected to the pin IREF.
7	VSEN	Voltage sensing input for constant battery voltage control. It is normally connected to the battery charger output through a resistor divider.
8	VCC	Power supply input. The typical operating voltage range is 2.5V to 16V.

Pin Assignments (Continued)

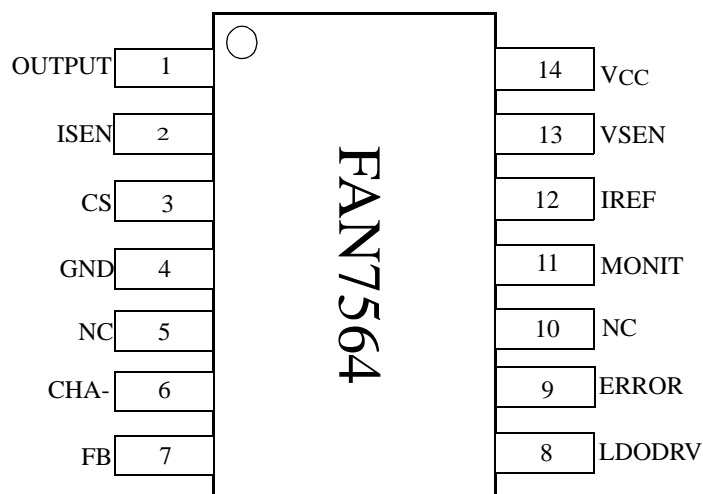

Pin Definitions (Continued)

Pin Number	Pin Name	Pin Function & Description
1	OUTPUT	Output pin for charging control. An external photocoupler is driven from the output for constant voltage and constant current charging control.
2	ISEN	Constant current loop reference Input.
3	CS	Charging current sensing input . It is connected to a sense resistor (system ground)
4	GND	Ground
6	CHA-	Charging current monitoring feedback input. monitoring output voltage can be changed by alternating the value of external resistor which is connected to the pin6, CHA-
7	FB	LDO output voltage sensing input. It is normally connected to the LDO output through a resistor divider.
8	LDODRV	LDO driving output. This is connected to the base of external TR (KSA539)
9	ERROR	LDO dropout error flag. This keeps the error signal off until the bias voltage for micro controller reaches the threshold voltage. Error signal becomes ON when the voltage reaches 4.8V. (With hysteresis 60mV)
11	MONIT	Charging current monitoring output. This pin is connected to a micro controller and detects the amplified voltage derived from CS pin.
12	IREF	Reference current control input. The Amplifier reference current is controlled according to the resistor which is connected to the pin IREF.
13	VSEN	Voltage sensing input for constant Battery voltage control. It is normally connected to the Battery charger output through a resistor divider.
14	VCC	Power supply input. The typical operating voltage range is 2.5V to 16V.

Absolute Maximum Ratings (Ta = 25°C)

Parameter	Symbol	Value	Unit
Supply Voltage	V _{CC}	2.5 ~ 16	V
Ldodrv Sink Current	I _{drv}	2	mA
Output Sink Current	I _O	20	mA
Power Dissipation	P _d	0.75	W
Operating Temperature Range	T _{opr}	-25 ~ 85	°C
Storage Temperature Range	T _{stg}	-65 ~ 150	°C

Electrical Characteristic (FAN7563)

(V_{CC} = 6V, Ta= 25°C, for min/max values Ta is the operating junction temperature range that applies(NOTE 1), unless otherwise noted.)

Parameter	Symbol	Conditions	Min.	Typ.	Max.	Unit
TOTAL DEVICE						
Input Supply Current	I _{CC}	V _{CC} =6V, I _{load} =1mA, I _O =0A	-	-	3	mA
REFERENCE SECTION						
Reference voltage	V _{ref}	V _{CC} =6V, I _{load} =50mA, Ta=25°C	1.23	1.245	1.26	V
		Full Temperature Range	1.22	1.245	1.27	
CONTROL PART						
UVLO Section						
High Threshold Voltage	V _{th} (H)	-	-	2.5	2.6	V
Low Threshold Voltage	V _{th} (L)	-	2.3	2.4	-	
Hysteresis 2	V _{hys} 2	-	-	0.1	-	
VOLTAGE SENSE SECTION						
Voltage Sense Threshold Voltage	V _{vsen}	V _{CC} = 6V, Ta = 25°C	1.23	1.245	1.26	V
		Full Temperature Range	1.22	1.245	1.27	
Threshold Voltage Temperature Coefficient	$\Delta V_{vsen} / \Delta T$	-	-	±0.01	-	%/°C
Input Bias Current	I _i	-	-	40	-	nA
Transconductance	g _m (V)	-	-	1	-	S
CURRENT SENSE SECTION						
Current Sense Threshold voltage	V _{isen}	V _{CC} = 6V, Ta=25°C	-190	-200	-210	mV
		Full Temperature Range	-	0	-	mV/°C
Transconductance	g _m	-	-	1	-	S
Current Reference Voltage	V _{iref}	R _{pin12} =25KΩ, Ta=25°C	1.23	1.245	1.26	V
		Full Temperature Range	1.22	1.245	1.27	
OUTPUT SECTION						
Output Sink Current	I _O	-	5	-	-	mA
Output Saturation Voltage	V _{sat}	I _O =5mA	-	200	400	mV

NOTE:

1. Tested ambient temperature range for the FAN7563: T_{low} = -25°C, T_{high}=85°C
2. $S = \frac{1}{R}$

Electrical Characteristic (Continued) (FAN7564)

(VCC = 6V, Ta = 25°C, for min/max values Ta is the operating junction temperature range that applies (NOTE 1), unless otherwise noted.)

Parameter	Symbol	Conditions	Min.	Typ.	Max.	Unit
TOTAL DEVICE						
Input Supply Current	ICC	VCC=6V, Iload=1mA, IO=0A	-	-	3	mA
REFERENCE SECTION						
Reference voltage	Vref	VCC=6V, Iload=50mA, Ta=25°C	1.23	1.245	1.26	V
		Full Temperature Range	1.22	1.245	1.27	
REGULATOR PART						
EXTERNAL OUTPUT SECTION (NOTE2)						
Line Regulation	$\Delta V_r(I_i)$	$6V \leq V_{CC} \leq 15V$	-	-	0.5	%max
Load Regulation	$\Delta V_r(I_O)$	$1mA \leq I_{load} \leq 100mA$	-	-	0.5	%max
Current Limit	ICL	VO=0V	110	-	-	mA
Output Voltage	VO	VCC=6V, Iload=50mA, Ta=25°C	4.95	5.0	5.05	V
		Full Temperature Range	4.9	5.0	5.1	
		$1mA \leq I_{load} \leq 100mA$ Full Temperature Range	4.88	5.0	5.12	
INTERNAL DRIVE SECTION						
LDODRV Sink Current	ldrv	VCC=6V	-	-	2	mA
ERROR COMPARATOR SECTION						
Output Low Voltage	VOL	VCC=(VO-0.5)V, IOL=500μA	-	150	400	mV
High Threshold Voltage	Vth	-	-	4.8	4.9	V
Low Threshold Voltage	Vtl	-	4.64	4.74	-	V
Hysteresis1	Vhys1	-	-	0.1	-	mV
CONTROL PART						
UVLO Section						
High Threshold Voltage	Vth(H)	-	-	2.5	2.6	V
Low Threshold Voltage	Vth(L)	-	2.3	2.4	-	
Hysteresis 2	Vhys1	-	-	60	-	
VOLTAGE SENSE SECTION						
Voltage Sense Threshold Voltage	Vvsen	VCC = 6V, Ta = 25°C	1.23	1.245	1.26	V
		Full Temperature Range	1.22	1.245	1.27	
Threshold Voltage Temperature Coefficient	$\Delta V_{vsen}/\Delta T$	-	-	±0.01	-	%/°C
Input Bias Current	li	-	-	40	-	nA
Transconductance	gm (V)	-	-	1	-	S
CURRENT SENSE SECTION						
Current Sense Threshold voltage	Visen	VCC = 6V, Ta=25°C	-190	-200	-210	mV
		Full Temperature Range	-	0	-	mV/°C
Transconductance	gm	-	-	1	-	S
Current Reference Voltage	Viref	Rpin12=25KΩ, Ta=25°C	1.23	1.245	1.26	V
		Full Temperature Range	1.22	1.245	1.27	

Electrical Characteristic (Continued) (FAN7564)

Parameter	Symbol	Conditions	Min.	Typ.	Max.	Unit
OUTPUT SECTION						
Output Sink Current	I_O	-	5	-	-	mA
Output Saturation Voltage	V_{sat}	$I_O=5mA$	-	200	400	mV

NOTE:

1. Tested ambient temperature range for the FAN7564: $T_{low} = -25^{\circ}C$, $T_{high}=85^{\circ}C$
2. Tested with Circuit 1. Output capacitor, C_o is commonly used to provide improved output impedance and rejection of transients. The regulated output voltage is given by : $V_o=V_{ref}*(1+R_a/R_b)$
3. $S = \frac{1}{R}$

Circuit 1.

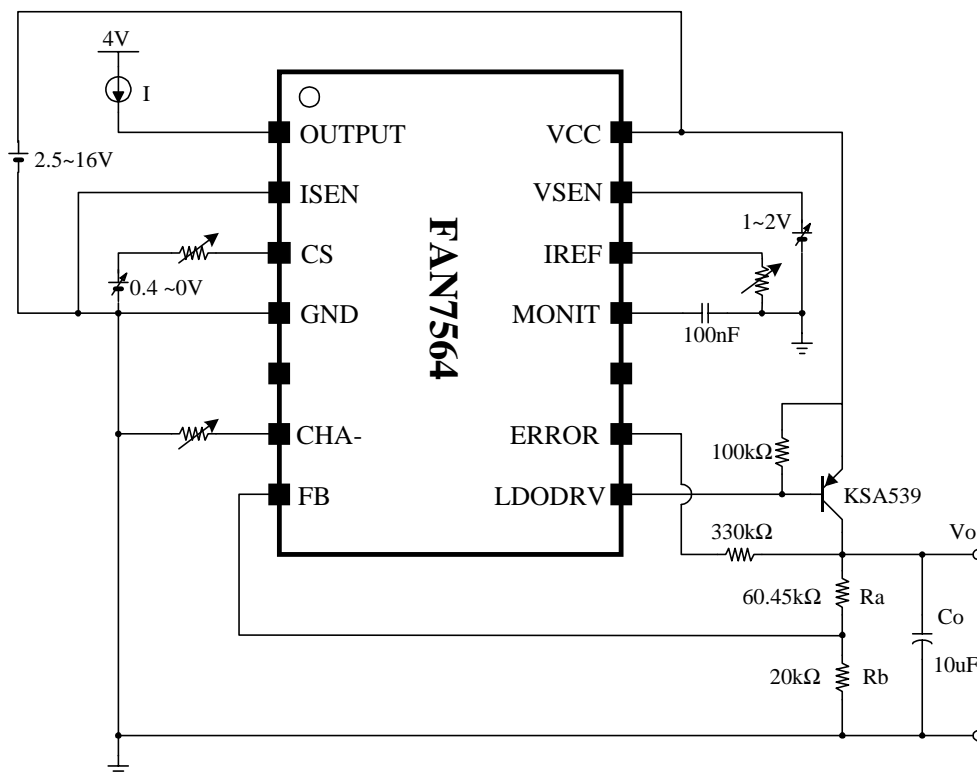

Typical Applications

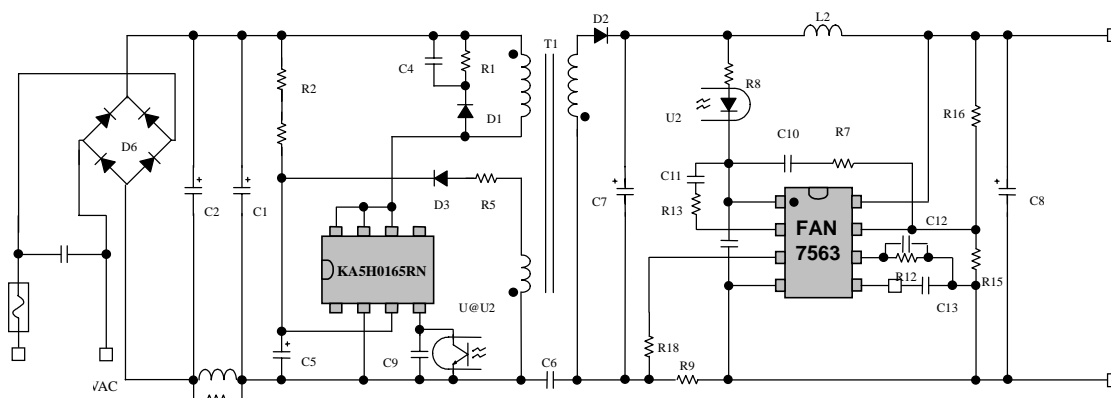

Part List (5.2V / 1.0A)

Part Number	Value	Remarks	Part Number	Value	Remarks
R1	100kΩ(1W)	-	C6	332	250VAC Y1
R2	240kΩ(1/8W)	Chip	C7	1000uF / 10V	Low ESR (105°C)
R3	240kΩ(1/8W)	Chip	C8	470uF / 10V	Low ESR (105°C)
R4	24kΩ(1/8 W)	Chip	C9	223	Chip Cap
R5	15Ω	Chip	C10	104	Chip Cap
R7	2.7kΩ	Chip	C11	104	Chip Cap
R8	100Ω	Chip	C12	472	Chip Cap
R9	0.1Ω	Sensing resistor	C13	104	Chip Cap
R12	27kΩ	Chip	C14	104	Chip Cap
R13	0Ω	Chip	D1	UF4007	-
R15	560Ω	Chip	D2	1N5822	Schottky
R16	1.8kΩ	Chip	D3	1N4148	Chip Diode
R18	2.2kΩ	Chip	D6	0.5A / 600V	Chip B/D
-	-	-	FUSE	1A / 250Vac	-
C1	10uF / 400V	-	U1	KA5H0165RN	Fairchild
C2	10uF / 400V	-	U2	PC817A	Opto Coupler
C3	7D471	-	U4	FAN7563	Fairchild
C4	332 / 1kV	-	L1	1mH	-
C5	10uF / 50V	-	L2	100uH	Coking Coil

Typical Performance Characteristics

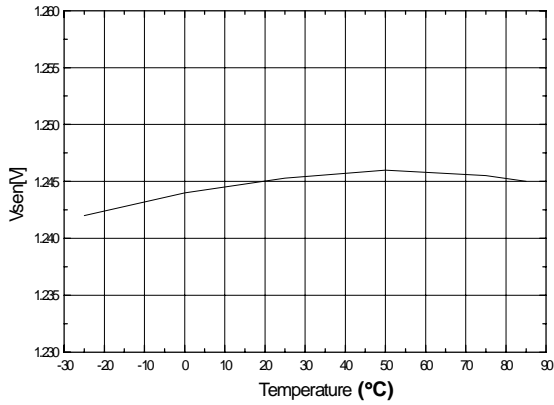

Figure 1. Voltage Sense Characteristic

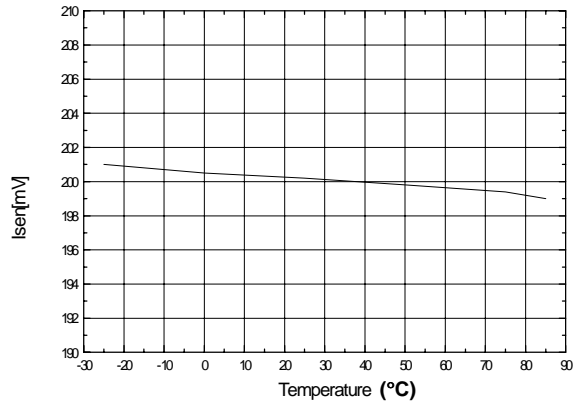

Figure 2. Current Sense Characteristic

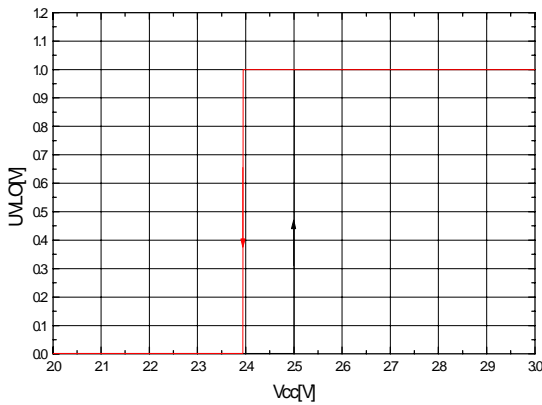

Figure 3. UVLO Characteristic

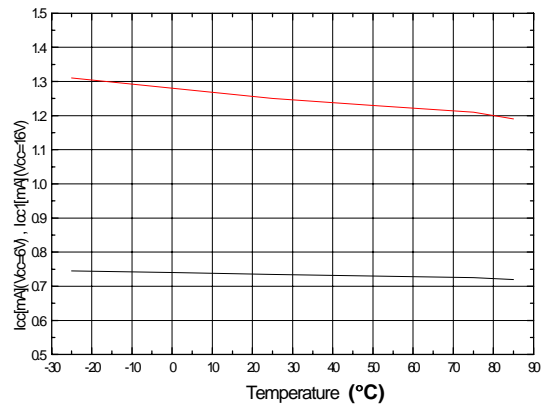

Figure 4. ICC, ICC1 Characteristic

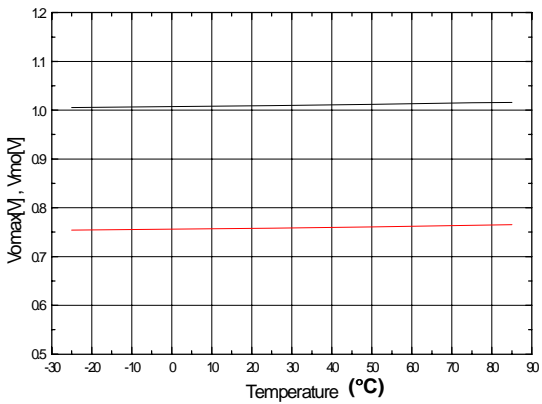

Figure 5. Vmo, Vmox Characteristic

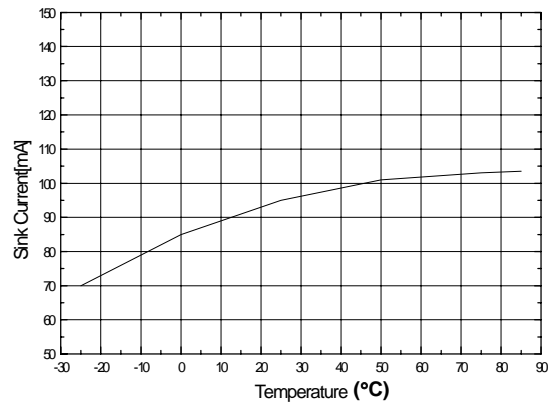

Figure 6. Max Output Sink Current Characteristic

Typical Performance Characteristics (Continued)

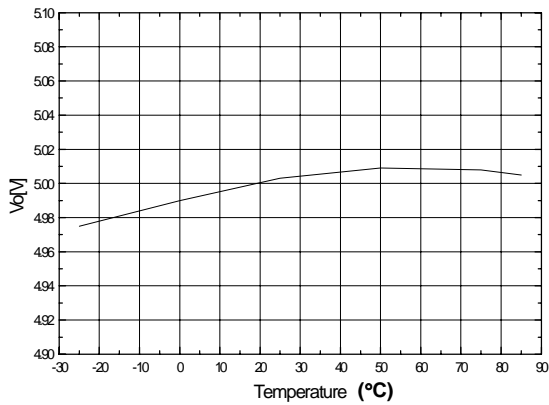

Figure 7. LDO Output Characteristic

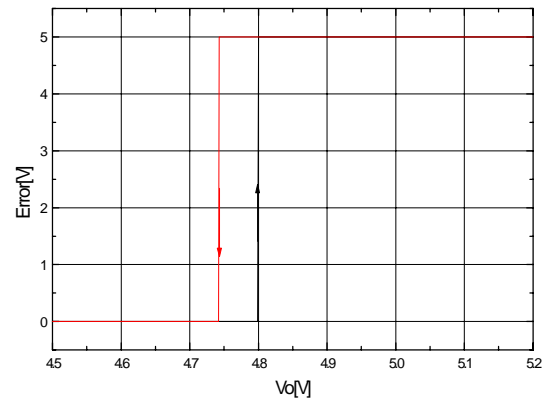

Figure 8. Error Flag Characteristic

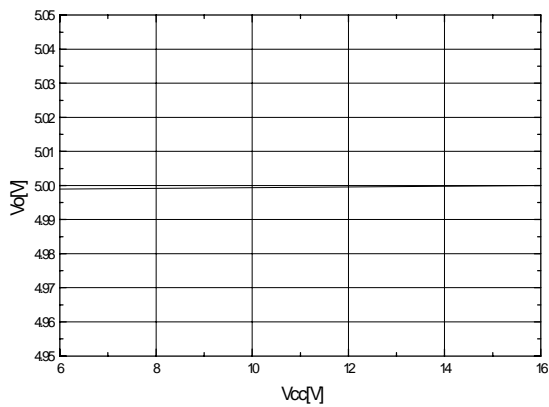

Figure 9. Line Regulation Characteristic

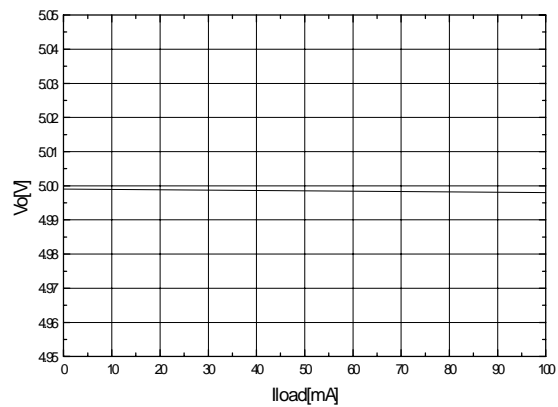

Figure 10. Load Regulation Characteristic

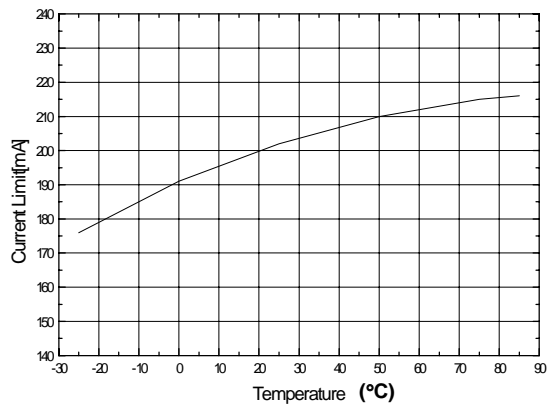

Figure 11. Current Limit Characteristic

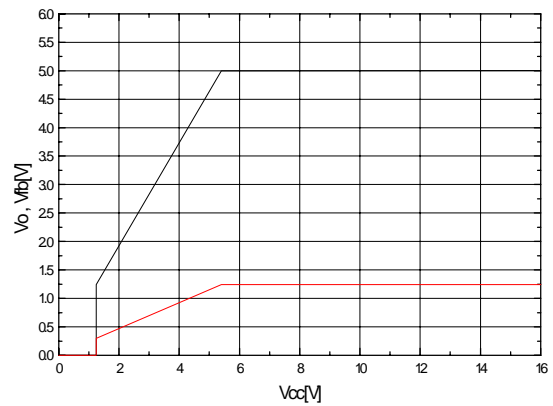

Figure 12. Start-up Characteristic (Io=100mA, with KSA539)

Mechanical Dimensions

Package

Dimensions in millimeters

8-SOP

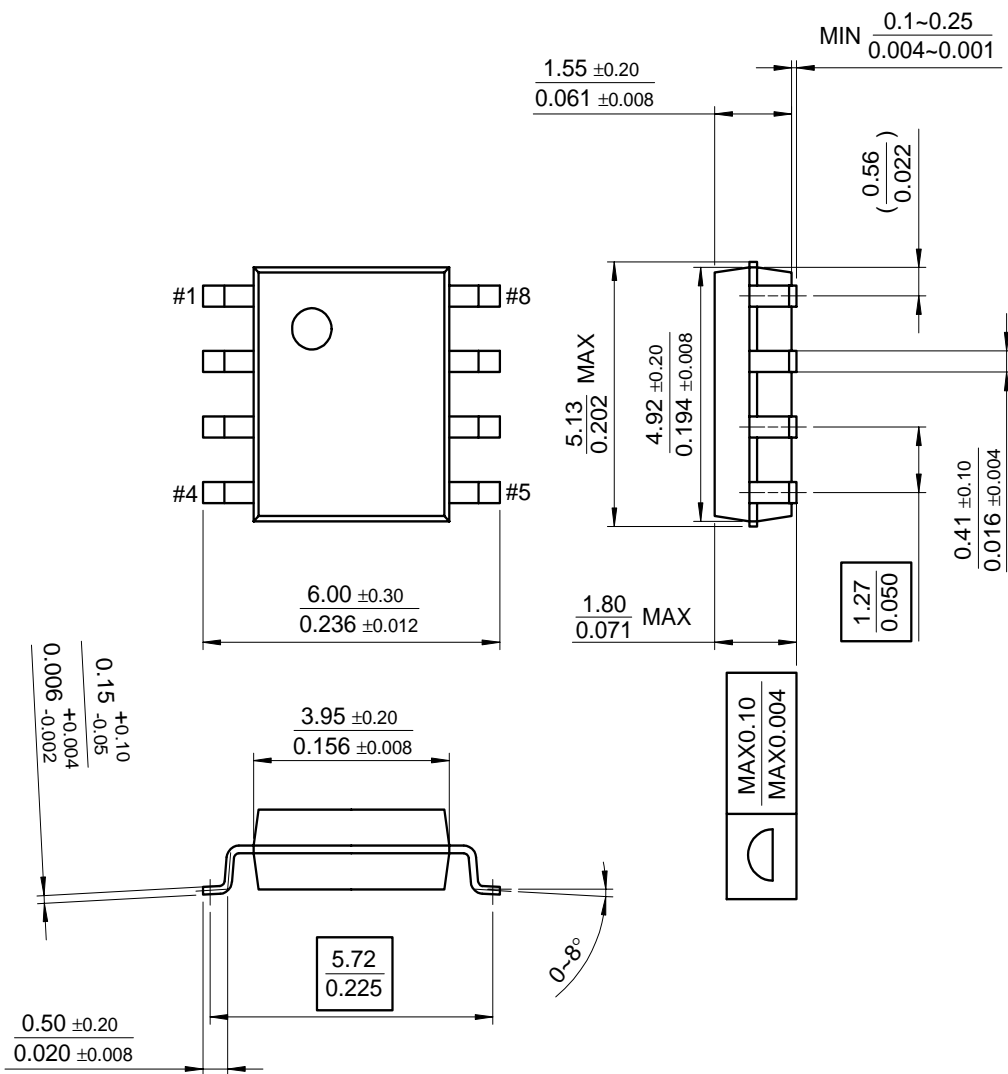

Mechanical Dimensions (Continued)

Package

Dimensions in millimeters

14-SOP

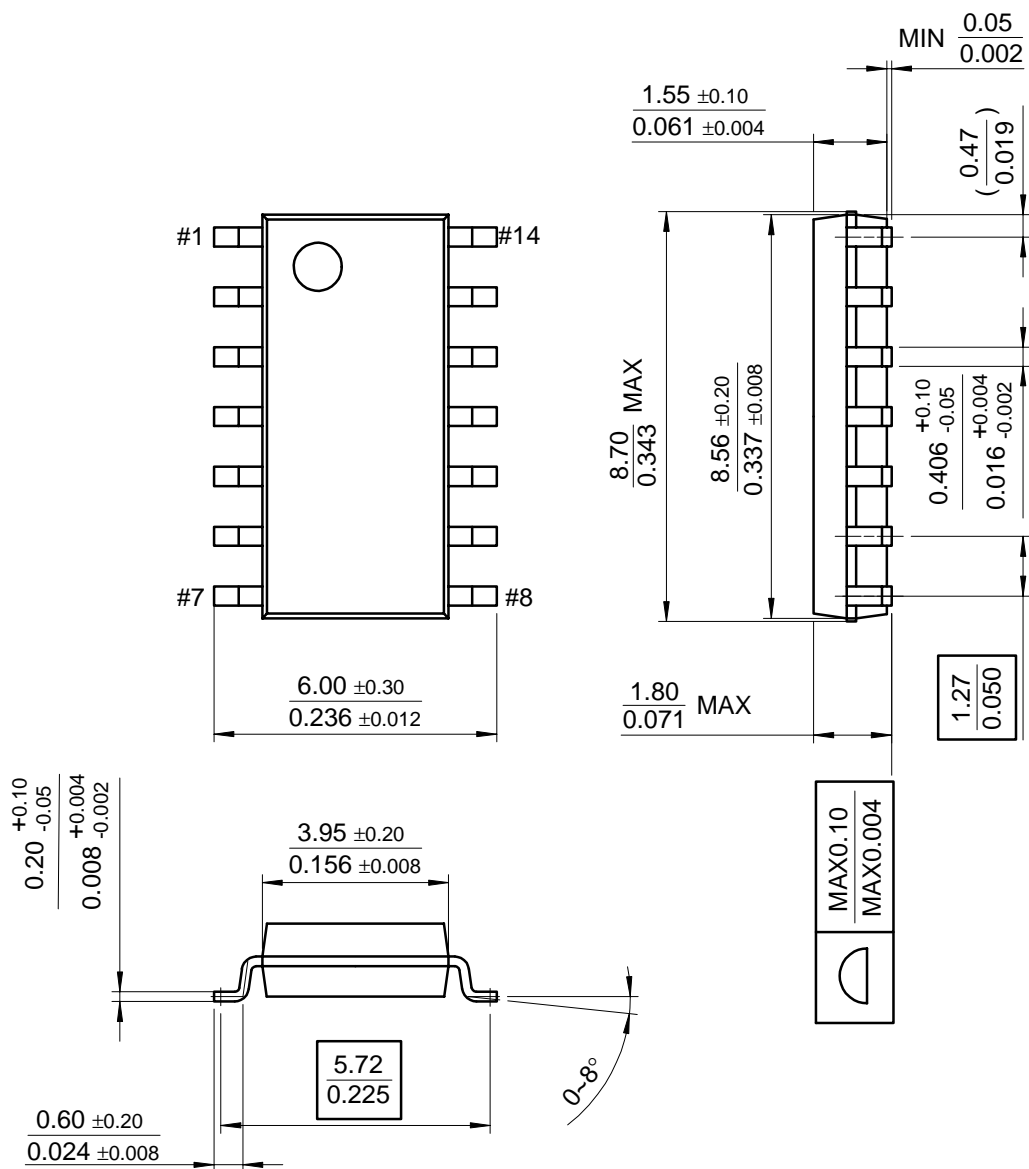

Ordering Information

Product Number	Package	Operating Temperature
FAN7563D	8-SOP	-25°C to +85°C
FAN7564D	14-SOP	

DISCLAIMER

FAIRCHILD SEMICONDUCTOR RESERVES THE RIGHT TO MAKE CHANGES WITHOUT FURTHER NOTICE TO ANY PRODUCTS HEREIN TO IMPROVE RELIABILITY, FUNCTION OR DESIGN. FAIRCHILD DOES NOT ASSUME ANY LIABILITY ARISING OUT OF THE APPLICATION OR USE OF ANY PRODUCT OR CIRCUIT DESCRIBED HEREIN; NEITHER DOES IT CONVEY ANY LICENSE UNDER ITS PATENT RIGHTS, NOR THE RIGHTS OF OTHERS.

LIFE SUPPORT POLICY

FAIRCHILD'S PRODUCTS ARE NOT AUTHORIZED FOR USE AS CRITICAL COMPONENTS IN LIFE SUPPORT DEVICES OR SYSTEMS WITHOUT THE EXPRESS WRITTEN APPROVAL OF THE PRESIDENT OF FAIRCHILD SEMICONDUCTOR CORPORATION. As used herein:

1. Life support devices or systems are devices or systems which, (a) are intended for surgical implant into the body, or (b) support or sustain life, and (c) whose failure to perform when properly used in accordance with instructions for use provided in the labeling, can be reasonably expected to result in a significant injury of the user.
2. A critical component in any component of a life support device or system whose failure to perform can be reasonably expected to cause the failure of the life support device or system, or to affect its safety or effectiveness.

Home >> Find products >>

FAN7563

Lithium-ion Charger Controller

Contents

- [General description](#)
- [Features](#)
- [Product status/pricing/packaging](#)
- [Order Samples](#)
- [Application notes](#)
- [Qualification Support](#)

General description

The FAN7563/FAN7564 is designed for Lithium-ion battery charger. This controls charging current and voltage of Lithium - ion battery as constant current and constant voltage control IC and can be used for stand alone charger (FAN7563) and micom interface charger(FAN7564). In addition, LDO regulator driving output which is integrated within FAN7564 enables to offers accurate reference voltage to power supply of micro controller, therefore, it features increasing stability and efficiency of charger set as well as minimizing external components of the set. Additionally, FAN7563/FAN7564 provide the protection functions like error flag, short circuit protection(LDO), and charging current control disable.

[back to top](#)

Features

- Constant Voltage & Constant Current Control
- Wide Operating Range of 2.5V ~ 16V
- Low-Side Source Return Current Sensing
- Externally Adjustable Charging Current Control
- Charging Current Monitoring
- Precision LDO Regulator Drive Ouptut (Adj) (Only FAN7564)
- Error signals of Output Dropout (LDO) (Only FAN7564)
- Current Limit (LDO) (FAN7564 Only)

[back to top](#)

Product status/pricing/packaging

BUY

BUY

Datasheet

[Download this datasheet](#)



[e-mail this datasheet](#)



This page

[Print version](#)

Related Links

[Request samples](#)

[How to order products](#)

[Product Change Notices \(PCNs\)](#)

[Support](#)

[Sales support](#)

[Quality and reliability](#)

[Design center](#)

Product	Product status	Pb-free Status	Package type	Leads	Packing method
FAN7563DTF	Lifetime Buy		SOIC	8	TAPE REEL

 Indicates product with Pb-free second-level interconnect. For more information [click here](#).

[back to top](#)

Application notes

[AN-4110: Charger Control IC for Off-Line Lithium-Ion Battery Charger](#) (42 K)
Jul 27, 2007

[back to top](#)

Qualification Support

Click on a product for detailed qualification data

Product
FAN7563DTF

[back to top](#)

© 2007 Fairchild Semiconductor

