

Single-cell Li-Ion Charger IC with System Power Management AUR9807

General Description

The AUR9807 is a single-cell Li-ion charger IC with system power management feature. It charges the battery and power the system simultaneously. The maximum charging current (up to 1.5A) is set by external resistor for fast charging. The output voltage for the system is regulated to a nominal value (three different versions available: 4.4V, 5V or 6V); the actual value of the output voltage depends on the input voltage from the adapter, the charging current and the system loading. With the decrease of the input voltage or the increase of the system loading current, the output voltage drops. When the output voltage drops to a predetermined value ($V_{APM-REG}$), the Active Power Management function is activated and tries to maintain the output voltage at $V_{APM-REG}$; the AUR9807 will suffice the system loading with first priority and reduce the charging current temporarily, i.e. under heavy load condition, the AUR9807 charges the battery with the remaining available current to keep the output voltage at V_{APM} . In this manner, the charge and discharge cycle of the battery can be reduced.

It is possible that the AUR9807 fails to maintain the output voltage at $V_{APM-REG}$; for example, when the system loading current exceeds the capability of the current-limiting AC adapter. In this scenario, the output voltage drops to the battery voltage, and the system is allowed to draw current from the battery.

The AUR9807 is available in QFN-4.5×3.5-20 package.

Features

- QFN Package
- Active Power Management (APM) for Simultaneously Powering the System and Charging the Battery
- Total Current Supported Up to 2 Amperes (System Loading Having Higher Priority on the Budget)
- Automatic Power Source Selection (AC Adapter or Battery)
- 40mΩ Power Path for the Battery to Supply the System Power Efficiently
- Junction Temperature Detection and Thermal Regulation During Charging Process
- External LED Indicating Charger and Power Good Status as Well as Fault Condition
- Thermal, Short-Circuit, and Reverse Current Protection
- Short-Circuit Protection in the Low Power Consumption Sleep Mode
- SYSOFF Function to Cut Off the Path Between the System and the Battery
- Built-in Over Voltage Protection up to 18V

Applications

- Battery-Powered Devices or Equipment
- Mobile Phones, Digital Cameras and MP3 Players
- Radios, Other Hand-Held Games and Instruments
- Solar Power System



Figure 1. Package Type of AUR9807

Single-cell Li-Ion Charger IC with System Power Management **AUR9807**

Pin Configuration

D Package
(QFN-4.5x3.5-20)

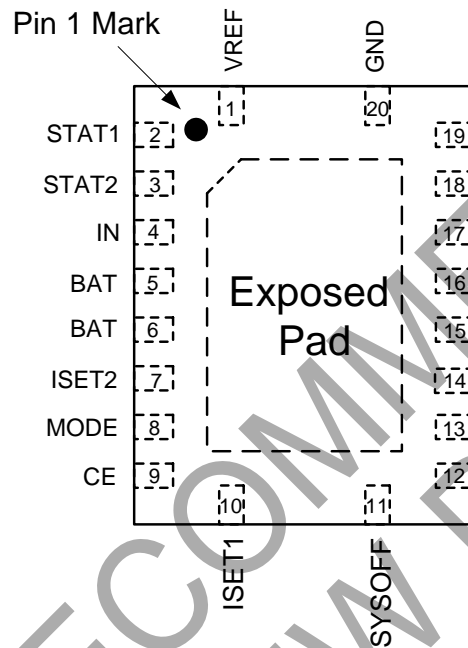

Figure 2. Pin Configuration of AUR9807 (Top View)

**Single-cell Li-Ion Charger IC with System Power Management AUR9807****Pin Description**

Pin Number	I/O	Pin Name	Function
1	O	VREF	Internal reference; VREF output capacitor not required, but one with a value of 0.1 μ F is recommended.
2	O	STAT1	Charge status flag 1 (open-drain)
3	O	STAT2	Charge status flag 2 (open-drain)
4	I	IN	Chip input voltage
5, 6	I/O	BAT	Battery connection; charging or discharging all through this pin
7	I	ISSET2	USB mode total current selection (High=450mA, Low=90mA) and AC mode charge current selection (High=Full current, Low=half current)
8	I	MODE	Set AUR9807 in AC(High) or USB(Low) mode
9	I	CE	Chip enable (active high)
10	I/O	ISSET1	Set the maximum charging current
11	I	SYSOFF	Cut off the power path between the battery and the output pin
12	I/O	TS	Battery Temperature sensing
13	I	APM	Active Power Management set point ※ no need for capacitors
14	I/O	TMR	Timer program by external resistor connected to this pin. Tying TMR and VREF together to disable the safety timer
15, 16, 17	O	OUT	System output
18	O	/PG	Power-good status flag (open-drain)
19, 20	I	GND	Chip Ground



Single-cell Li-Ion Charger IC with System Power Management AUR9807

Functional Block Diagram

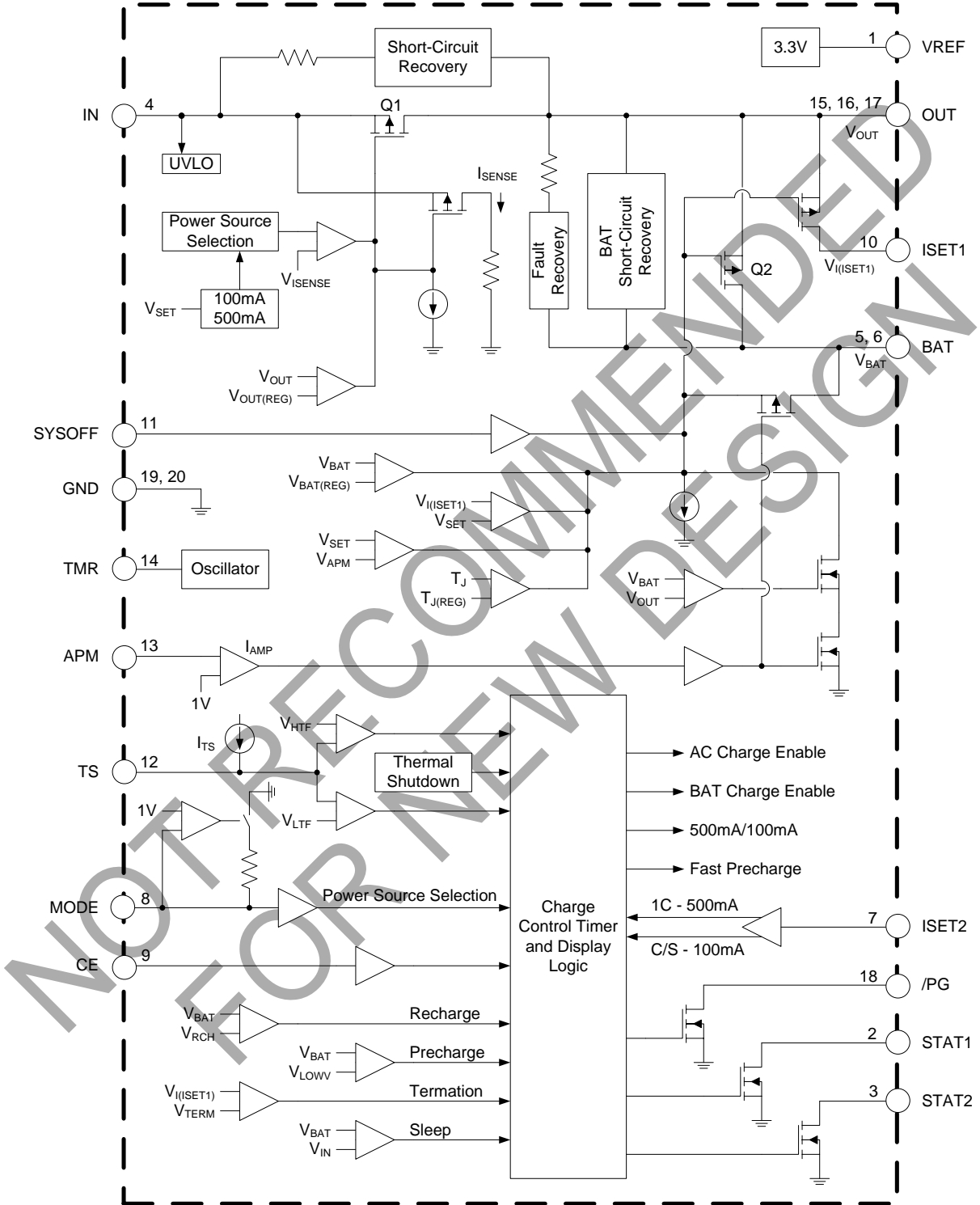
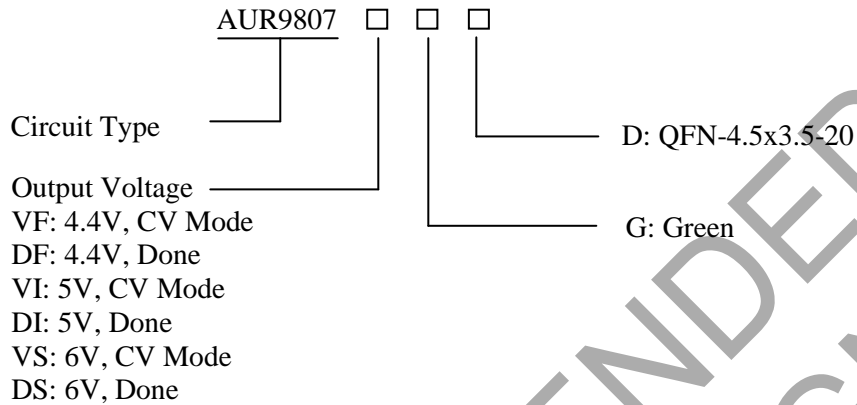

Figure 3. Functional Block Diagram of AUR9807



Single-cell Li-Ion Charger IC with System Power Management AUR9807

Ordering Information



CV mode: After charge done, charger will stay in constant voltage mode until time out.

Done: After charge done, charger will shut down until the battery voltage drops below the battery recharge threshold.

Package	Temperature Range	Output Voltage	Part Number	Marking ID	Packing Type
QFN-4.5x3.5-20	-40 to 85°C	4.4V, CV Mode	AUR9807VFGD	A9807VFG	Tape & Reel
		4.4V, Done	AUR9807DFGD	A9807DFG	Tape & Reel
		5V, CV Mode	AUR9807VIGD	A9807VIG	Tape & Reel
		5V, Done	AUR9807DIGD	A9807DIG	Tape & Reel
		6V, CV Mode	AUR9807VSGD	A9807VSG	Tape & Reel
		6V, Done	AUR9807DSGD	A9807DSG	Tape & Reel

BCD Semiconductor's Pb-free products, as designated with "G" in the part number, are RoHS compliant and green.

**Single-cell Li-Ion Charger IC with System Power Management AUR9807****Absolute Maximum Ratings (Note 1)**

Parameter	Symbol	Value	Unit
Supply Input Voltage	V_{IN}	-0.3 to 18	V
Input Voltage	$V_{BAT}, V_{CE}, V_{APM}, V_{PG}, V_{MODE}, V_{OUT}, V_{ISET1}, V_{ISET2}, V_{STAT1}, V_{STAT2}, V_{TS}$	-0.3 to 7	V
	V_{REF}	-0.3 to $V_{OUT}+0.3$	V
	V_{TMR}	-0.3 to $V_{OUT}+0.3$	V
Input Current	I_{IN}	3.5	A
Output Current	I_{OUT}	4	A
	I_{BAT}	-4 to 1.5	A
Output Source Current (In Regulation at 3.3V V_{REF})	I_{REF}	30	mA
Output Sink Current	$I_{PG}, I_{STAT1}, I_{STAT2}$	15	mA
Thermal Resistance (Junction to Ambient)	θ_{JA}	52	°C/W
Storage Temperature	T_{STG}	-65 to 150	°C
Junction Temperature	T_J	-40 to 150	°C
Lead Temperature (Soldering, 10 Seconds)		300	°C
ESD (Human Body Model)	V_{HBM}	2000	V
ESD (Machine Model)	V_{MM}	200	V

Note 1: Stresses greater than those listed under “Absolute Maximum Ratings” may cause permanent damage to the device. These are stress ratings only, and functional operation of the device at these or any other conditions beyond those indicated under “Recommended Operating Conditions” is not implied. Exposure to “Absolute Maximum Ratings” for extended periods may affect device reliability.

Recommended Operating Conditions

Parameter	Symbol	Min	Max	Unit
Supply Voltage	AUR9807DSGD, AUR9807VSGD	4.35	6.3	V
	AUR9807DFGD, AUR9807VFGD, AUR9807DIGD, AUR9807VIGD	4.35	5.5	V
Input Current	I_{IN}		2	A
Operating Junction Temperature Range	T_{OP}	-40	125	°C

**Single-cell Li-Ion Charger IC with System Power Management AUR9807****Electrical Characteristics**T_A=25°C, V_{IN} is within the recommended range, unless otherwise specified.

Parameter	Symbol	Test Condition	Min	Typ	Max	Unit
Active Supply Current	I _{IN(SPLY)}	V _{IN} >4.35V		1.1	2	mA
Sleep Mode Current into BAT Pin	I _{BAT(SLP)}	V _{IN} <V _{BAT} , 2.6V<V _{BAT} <V _{BAT(REG)} No load at OUT pin		2.5	5	μA
Input Pin Standby Current	I _{IN(STDBY)}	V _{IN} <6V, Total current flow into IN pin with CE pin low; no load			200	μA
BAT Pin Standby Current	I _{BAT(STDBY)}	Total current flow into BAT pin with input source present and CE pin low		45	65	μA
Charge Done Current, BAT	I _{BAT(TERM)}	Current flows into BAT pin after the termination of the charging process		1	5	μA
Q1,Q2 DROP-OUT VOLTAGE						
IN to OUT Dropout Voltage	V _{DO(IN-OUT)}	MODE=High, I _{IN} =1A		300	475	mV
BAT to OUT Dropout Voltage	V _{DO(BAT-OUT)}	V _{BAT} > 4V, I _{BAT} =1A		40	100	mV
VOLTAGE REGULATION						
Regulation V _{OUT} 9807VF 9807DF	V _{OUT(REG)}	V _{IN} >4.4V+V _{DO(IN-OUT)}		4.4	4.5	V
Regulation V _{OUT} 9807VI 9807DI	V _{OUT(REG)}	V _{IN} >5V+V _{DO(IN-OUT)}		4.9	5.1	V
Regulation V _{OUT} 9807VS 9807DS	V _{OUT(REG)}	V _{IN} >6V+V _{DO(IN-OUT)}		6	6.3	V
APM REGULATION						
APM Set Point	V _{APM-SET}	V _{APM-SET} <V _{OUT}	2.6		3.8	V
APM Current Source	I _{APM-SET}	Input present	95	100	105	μA
APM Scale Factor	SF	V _{APM-REG} =V _{APM-SET} x SF	1.139	1.15	1.162	
BATTERY SUPPLEMENT MODE						
Run Battery Supplement Mode	V _{BSUP1}	V _{BAT} >2V		V _{OUT} <V _{BAT} -60mV		V
Escape Battery Supplement Mode	V _{BSUP2}	V _{BAT} >2V			V _{OUT} >V _{BAT} -20mV	V
CHARGING-PRECHARGE						
Precharge to Fast-charge Transition Voltage	V _{LOWV}	Voltage on BAT	2.9	3	3.1	V
Precharge Current Range	I _{PRECHG}		10		150	mA

**Single-cell Li-Ion Charger IC with System Power Management AUR9807****Electrical Characteristics (Continued)**T_A=25°C, V_{IN} is within the recommended range, unless otherwise specified.

Parameter	Symbol	Test Condition	Min	Typ	Max	Unit
Precharge Set Voltage	V _{PRECHG}		225	250	275	mV
De-glitch Time Between Fast Charge and Precharge Transition	t _{DGLF}	t _{FALL} =100ns, 10mV overdrive, V _{BAT} decreasing below threshold		22.5		ms
CHARGING-CURRENT REGULATION						
Fast Charge Current Range	I _{CHG}	V _{BAT} >V _{LOWV} , Mode=High	100	1000	1500	mA
BAT to OUT Pull-up	R _{PBAT}	V _{BAT} <1V		1000		Ω
Battery Charge Current Set Voltage ⁽¹⁾	V _{SET}	Voltage on ISET1	2.4	2.5	2.6	V
Charge Current Set Factor	K _{SET}	100mA<I _{CHG} <1.5A	375	425	450	
		10mA<I _{CHG} <100mA	300	450	600	
USB MODE INPUT CURRENT LIMIT						
USB Input Current Range	I _{USB}	ISET2=High	400		500	mA
		ISET2=Low	80	90	100	
CHARGING VOLTAGE REGULATION						
Battery-charge-voltage				4.2		V
Battery Charge Voltage Regulation Accuracy	V _{BAT(REG)}	T _A =25 °C	-0.5		0.5	%
			-1		1	%
CHARGE TERMINATION DETECTION						
Charge Done Detection Current	I _{TERM}	V _{BAT} >V _{RCH} , I _{TERM} =(K _{SET} x V _{TERM})/ R _{SET}	10		150	mA
Charge Done Set Voltage, Measured on ISET1	V _{TERM}	V _{BAT} >V _{RCH} , Mode=High	230	250	270	mV
		V _{BAT} >V _{RCH} , Mode=Low	95	100	130	
TEMPERATURE SENSE COMPARATORS						
High Voltage, Low Temperature Threshold	V _{LTF}	Temp fault at V _{TS} >V _{LTF}		2.5		V
Low Voltage, High Temperature Threshold	V _{HTF}	Temp fault at V _{TS} <V _{HTF}		0.5		V
Current Source for Temperature Sense	I _{TS}		95	100	105	μA
BATTERY RECHARGE THRESHOLD						
Recharge Threshold Voltage	V _{RCH}		V _{BAT(REG)} -0.125	V _{BAT(REG)} -0.1	V _{BAT(REG)} -0.075	V

(1) For half-charge rate, V_{SET} is 1.25V.

**Single-cell Li-Ion Charger IC with System Power Management AUR9807****Electrical Characteristics (Continued)**T_A=25°C, V_{IN} is within the recommended range, unless otherwise specified.

Parameter	Symbol	Test Condition	Min	Typ	Max	Unit
STAT1, STAT2, AND /PG						
Low-level Output Saturation Voltage	V _{OL}	I _{OL} =5mA, requiring an external pull-up resistor > 1kΩ			0.25	V
Input Leakage Current	I _{LKG}			1	5	μA
ISET2, CE						
CE Pin Hold-off Time	t _{CE-HLDOF} _F	CE fall low only	4		6	ms
Low-level Input Voltage	V _{IL}		0		1.1	V
High-level Input Voltage	V _{IH}		1.5			
CE Pin Low-level Input Current	I _{IL1}		-1			μA
CE Pin High-level Input Current	I _{IH1}				1	
ISET2 Pin Low-level Input Current	I _{IL2}	V _{ISET2} =0.4V	-20			
ISET2 Pin High-level Input Current	I _{IH2}	V _{ISET2} =V _{IN}			40	
MODE						
Mode Pin Low-level Input Voltage	V _{IL}	Falling Hi→Low; 280kΩ±10% applied when low	0.975	1	1.025	V
Mode Pin High-level Input Voltage	V _{IH}	Input R _{MODE} sets external hysteresis	V _{IL} +0.01		V _{IL} +0.024	V
Mode Pin Low-level Input Current	I _{IL}		-1			μA
TIMERS						
Timer Set Factor	K _{TMR}	t _{CHG} =K _{TMR} × R _{TMR}	0.313	0.36	0.414	s/Ω
External Resistor Limits	R _{TMR}		30		100	kΩ
Precharge Timer	t _{PRECHG}		0.115 × t _{CHG}	0.125 × t _{CHG}	0.135 × t _{CHG}	s
Timer Fault Recovery Pull-up from OUT to BAT	R _{FAULT}			1		kΩ
Time Out Extension Factor1	K _{EXT1}	The actual charge current less than 50% of maximum fast charge current		2		
Time Out Extension Factor2	K _{EXT2}	The actual charge current less than 25% of maximum fast charge current		4		

**Single-cell Li-Ion Charger IC with System Power Management AUR9807****Electrical Characteristics (Continued)**T_A=25°C, V_{IN} is within the recommended range, unless otherwise specified.

Parameter	Symbol	Test Condition	Min	Typ	Max	Unit
CHARGER SLEEP THRESHOLDS						
Sleep-mode Entry Threshold	V _{SLPENT}				V _{BAT} +0.125	mV
Sleep-mode Exit Threshold	V _{SLPEXIT}		V _{BAT} +0.195			
DE-GLITCH TIME						
De-glitch Time for Charge Done Detection, Temperature Fault, Recharge and Sleep Mode Detection	t _{DEG}			18.75		ms
START-UP CONTROL BOOT-UP						
Boot-up Time	t _{BOOT-UP}	On the first application of input low	120	150	180	ms
SWITCHING POWER SOURCE TIMING						
Switching Power Source from Input to Battery	t _{SW-BAT}	When input applied. Measure from: [PG: Lo → Hi to I _{IN} >5 mA]			50	μs
THERMAL SHUTDOWN REGULATION						
Temperature Trip	T _{SHTDWN}	T _J (Q1 and Q3 only)		150		°C
Thermal Hysteresis		T _J (Q1 and Q3 only)		25		
Temperature Regulation Limit	T _{J(REG)}	T _J (Q2)	110		130	
UVLO						
Under-voltage Lockout	V _{UVLO}	Decreasing V _{IN}	2.45	2.5	2.65	V
Input Power Detection Threshold	V _{IN(DT)}	Input power detected when V _{IN} >V _{BAT} + V _{IN(DT)} V _{BAT} =3.6V V _{IN} : 3.5V → 4V	55	80	130	mV
Hysteresis				27		mV
VREF OUTPUT						
Output Regulation Voltage	V _{REF}	Active only if ADP or USB is present		3.3		V
Regulation Accuracy			-5		+5	%
Output Current	I _{REF}				20	mA
On Resistance	R _{DS(ON)}	OUT to VREF			50	Ω
Output Capacitance	C _{OUT}				1	μF



Single-cell Li-Ion Charger IC with System Power Management AUR9807

Electrical Characteristics (Continued)

T_A=25°C, V_{IN} is within the recommended range, unless otherwise specified.

SHORT CIRCUIT PROTECTION						
Short-circuit Recovery Between BAT to OUT	I _{OSH1}	Pull-up source from BAT to OUT for short-circuit recovery V _{OUT} <V _{BAT} -200mV		10		mA
IN to OUT Short-circuit Protection	R _{SHAC}	V _{OUT} <1V		500		Ω
Output Short-circuit Detection Threshold, Power-on	V _{OUT(SC1)}	V _{IN} >V _{UVLO} and V _{IN} >V _{BAT} + V _{IN(DT)}	0.9	1	1.1	V
Output Short-circuit Detection Threshold, Supplement mode (V _{BAT} - V _{OUT})>V _{OUT(SC2)} Indicates Short-circuit	V _{OUT(SC2)}	V _{BAT} >2.5V	160	200	240	mV
Deglitch Time, Supplement Mode Short Circuit	t _{DGL(SC2)}			512		μs
Maximum Short-current for V _{BAT} >V _{OUT}	I _{SHORT} ⁽²⁾	V _{BAT} >2.5V			9	A

(2) For short current>I_{SHORT}, short-protection may not work due to avalanche breakdown phenomenon.

Typical Performance Characteristics

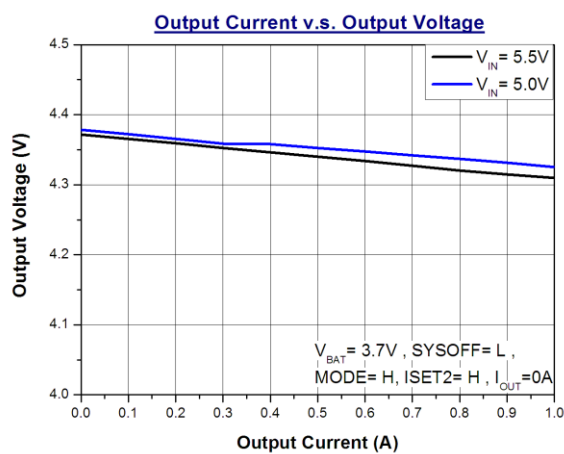

Figure 4. Output Voltage vs. Output Current

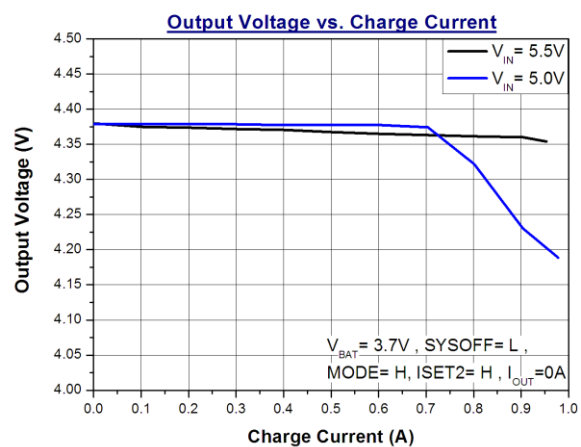

Figure 5. Output Voltage vs. Charge Current



Single-cell Li-Ion Charger IC with System Power Management AUR9807

Typical Performance Characteristics (Continued)

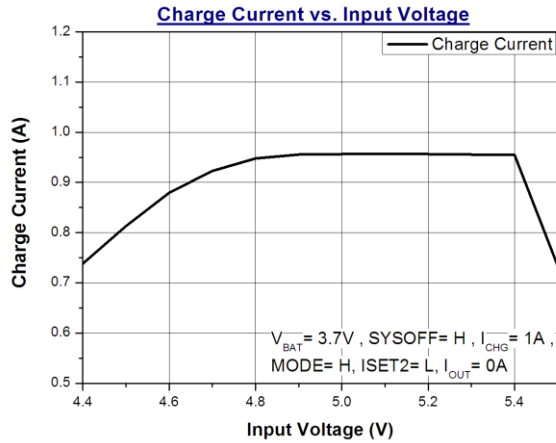

Figure 6. Charge Current vs. Input Voltage

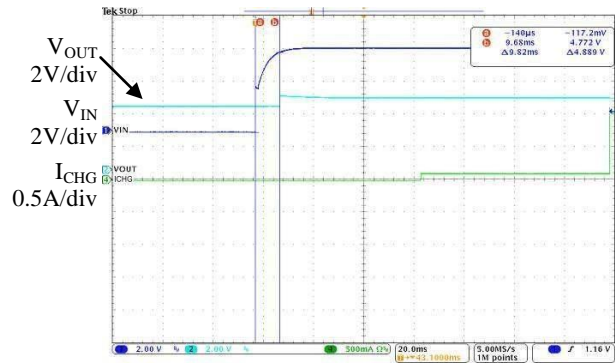

Figure 7. Power On

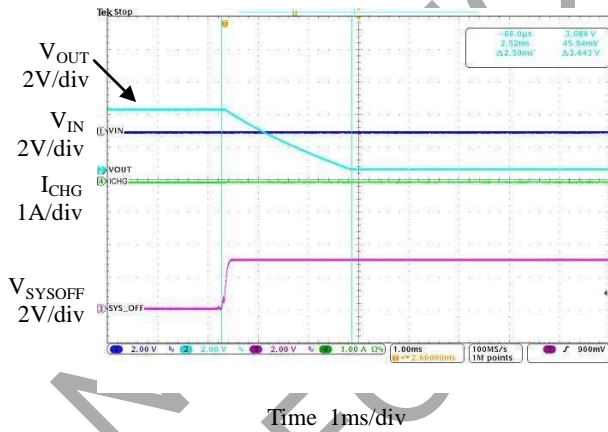

Figure 8. SYSOFF Floating

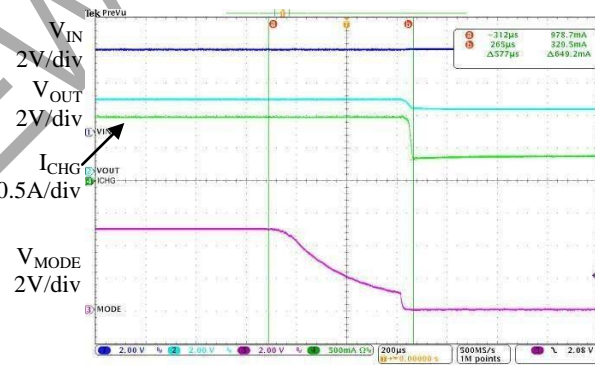
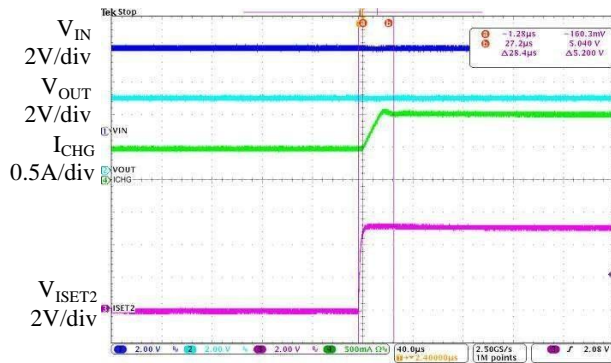

Figure 9. MODE Pin Pull Low



Single-cell Li-Ion Charger IC with System Power Management AUR9807

Typical Performance Characteristics (Continued)



Time 40µs/div

Figure 10. ISET2 Pin Pull High

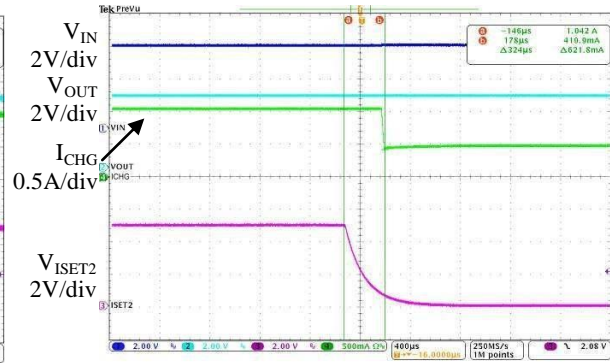

Time 400µs/div

Figure 11. ISET2 Pin Pull Low

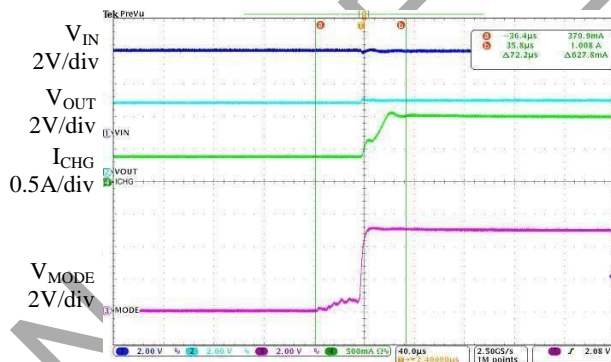

Time 40µs/div

Figure 12. MODE Pin Pull High

Single-cell Li-Ion Charger IC with System Power Management AUR9807

Power Flow

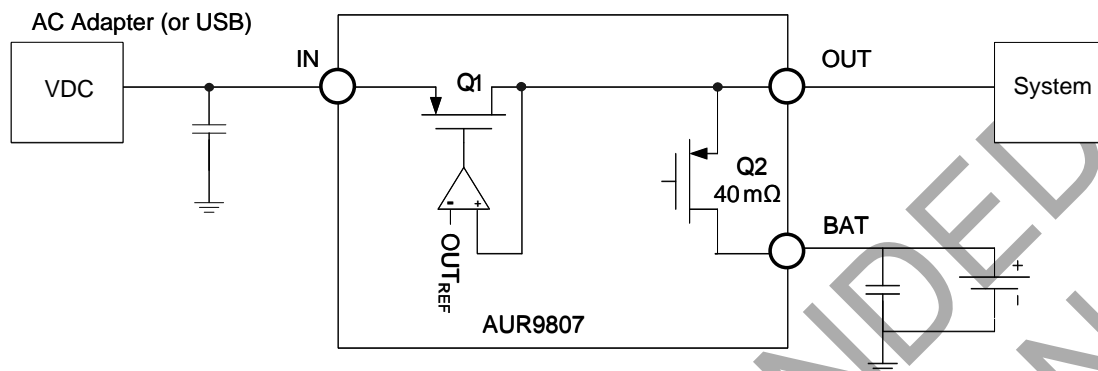

The AUR9807 selects the power source automatically. In the absence of the input source (AC adapter or USB), the battery is chosen to power the system. Under this circumstance, the AUR9807 consumes less than 5μA; the power path resistance from the battery to the system is only 40mΩ⁽³⁾; all these guarantee a high efficiency and elongate the battery discharge time. With this stringent sleep current budget (<5μA), the AUR9807 is still able to detect an output short condition and cuts off the power path between the battery and the system under short condition.

With the input power present, the MODE pin sets the AUR9807 in adapter mode or USB mode. In adapter mode, the AUR9807 does not limit the total current

directly, current limiting phenomenon occurs through Adaptive Power Management in response to the output voltage drop. The resistor connected to ISET1 pin sets the maximum charging current. This maximum charging current can be halved by pulling down the ISET2 pin. In USB mode, the AUR9807 will limit the total current within 450mA (ISET2=High) or 90mA (ISET2=Low). The maximum charging current is still set by the resistor connected to ISET1 pin; however, because of this current limiting feature, the actual charging current is usually less than 450mA (or 90mA).

(3) Q2 design value is 40mΩ.

Power Source Selection and Charge Current Setting

MODE Pin Level	AC Adapter	Loading Power Source	Charge Current Setting
Low	Yes	USB	ISET1, limitation depends on ISET2 setting
	No	Battery	N/A
High	Yes	AC Adapter	ISET1, half charging rate by setting ISET2 to low
	No	Battery	N/A



Single-cell Li-Ion Charger IC with System Power Management AUR9807

Charge Function Descriptions

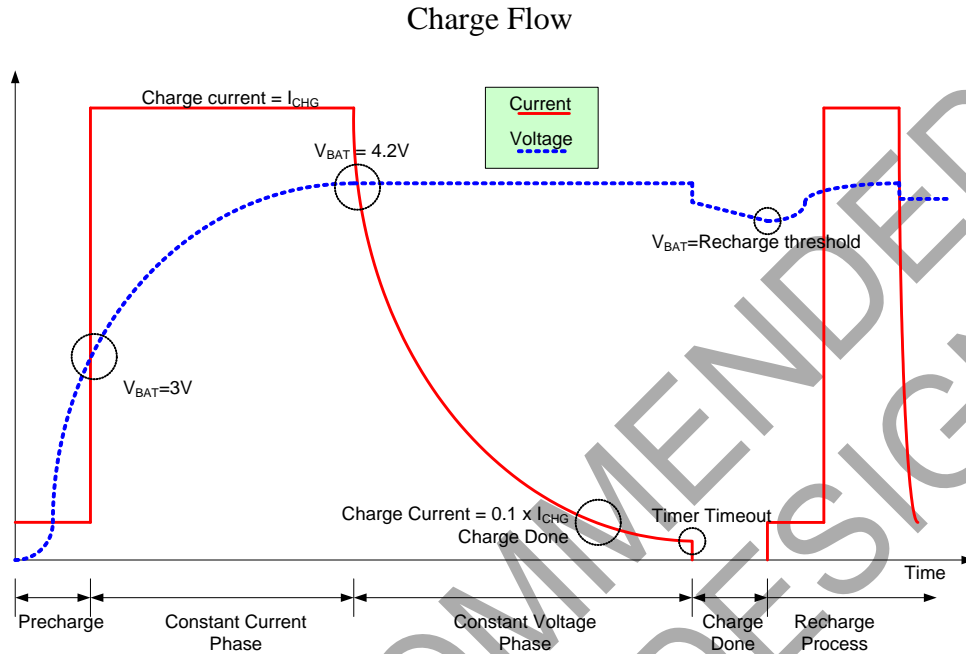

		Maximum Charging Current Setting	Pre-charge and Charge Done Current Setting
MODE=High	ISET2=High	$I_{CHG} = \frac{V_{SET} \times K_{SET}}{R_{SET}}, V_{SET, max} = 2.5$	$I_{PRECHG} = \frac{I_{CHG, max}}{10};$ $I_{TERM} = \frac{I_{CHG, max}}{10}; ACMode$
MODE=High	ISET2=Low	$I_{CHG} = \frac{V_{SET} \times K_{SET}}{R_{SET}}, V_{SET, max} = 1.25$	$I_{PRECHG} = \frac{I_{CHG, max}}{20}$ $I_{TERM} = \frac{I_{CHG, max}}{20}; ACMode$
MODE=Low	ISET2=High/Low	$I_{CHG} = \frac{V_{SET} \times K_{SET}}{R_{SET}}, V_{SET, max} = 2.5$	$I_{PRECHG} = \frac{I_{CHG, max}}{10}$ $I_{TERM} = \frac{I_{CHG, max}}{25}; USB Mode$

Single-cell Li-Ion Charger IC with System Power Management AUR9807

Charge Function Descriptions (Continued)

The maximum charging current, the pre-charge current and charge done current setting are given in the above table. The charging process begins with a pre-charge phase; when the battery voltage reaches the pre-charge threshold V_{LOWV} , the charger enters the constant current mode. At this stage, the charger tries to charge the battery with the maximum charging current (a constant); however, the actual charging current may be lower due to Active Power Management activated by large system loading or insufficient input current capability. The thermal fold-back mechanism also reduces the actual charging current when the junction temperature is over 110°C . The battery voltage rises gradually with the constant current entering the battery.

When the battery voltage reaches $V_{BAT(REG)}$, the charger enters the constant voltage mode. At this stage, the charger keeps the battery voltage at $V_{BAT(REG)}$ with a decreasing charging current. When the charging current drops below the charge done

current setting, nominally the charging process is complete (this can be observed from the external indicator). Depending on different versions, after the charge done status indicated, the charger will stop providing charging current completely or stay in constant voltage mode till time out. When the battery voltage drops below the recharge threshold, a new charge cycle begins.

Example:

With a $R_{SET}=1\text{k}\Omega$, the maximum charging current is about 1A for $ISET2=High$ and 0.5A for $ISET2=Low$. The pre-charge current I_{PRECHG} is 100mA. The charge done current setting is 100mA for AC mode and 40mA for USB mode. Note the absolute values of pre-charge current and charge done current setting do not vary with $ISET2$.

Power Source Selecting

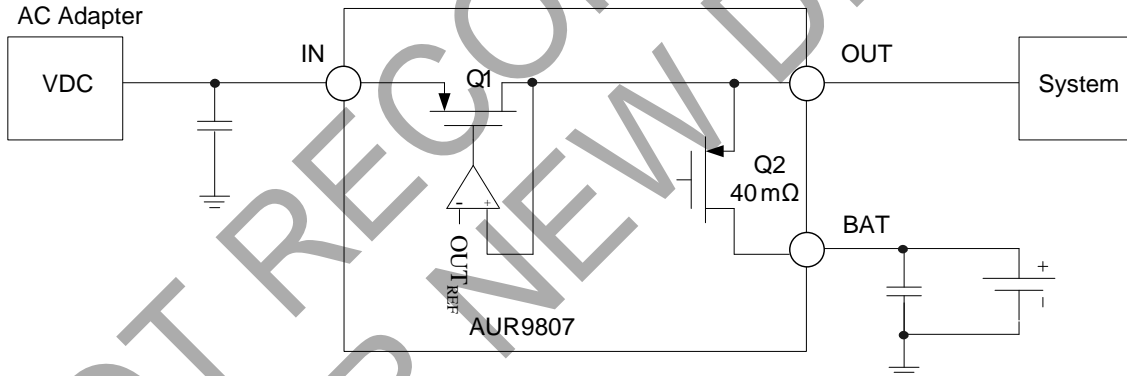

- i. $V_{IN} < V_{BAT} : V_{OUT} = V_{BAT} - V_{DO(BAT-OUT)}$
- ii. $V_{BAT} < V_{IN} < V_{OUT(REG)} : V_{OUT} = V_{IN} - V_{DO(IN-OUT)}$
- iii. $V_{OUT(REG)} + V_{DO(IN-OUT)} < V_{IN} < 6V : V_{OUT} = V_{OUT(REG)}$
- iv. $6V < V_{IN} : V_{OUT} = V_{BAT} - V_{DO(BAT-OUT)}$

The AUR9807 selects power source automatically depending on the voltage present at the input. When V_{IN} is lower than V_{BAT} , the battery is responsible to power the system. The output voltage V_{OUT} is $V_{BAT} - V_{DO(BAT-OUT)}$. When the input voltage V_{IN} is higher than V_{BAT} and lower than 6V, the input source is used to supply the system power; the output voltage depends on V_{IN} . When V_{IN} is lower than $V_{OUT(REG)}$,

the output voltage V_{OUT} is $V_{IN} - V_{DO(IN-OUT)}$; when V_{IN} is high enough, which means that $V_{IN} > (V_{OUT(REG)} + V_{DO(IN-OUT)})$, the output voltage is regulated at $V_{OUT(REG)}$. When the input voltage V_{IN} is higher than 6V, the current path between IN and OUT is cut off to protect the chip; AUR9807 therefore selects the Battery as the power source; the output voltage V_{OUT} is then $V_{BAT} - V_{DO(BAT-OUT)}$.

Single-cell Li-Ion Charger IC with System Power Management AUR9807

Charge Function Descriptions (Continued)

Active Power Management (APM)

■ AC MODE (MODE=HIGH)

- i. $V_{APM-REG} < V_{OUT}$: Normal Mode; I_{CHG} determined by R_{SET}
- ii. $V_{BAT} < V_{OUT} < V_{APM-REG}$: APM mode ; $I_{CHG} = I_{supply\ max} - I_{OUT}$
- iii. $V_{OUT} < V_{BAT}$: BAT supply mode

■ USB 500 MODE (MODE=LOW , ISET2=HIGH)

- i. $V_{APM-REG} < V_{OUT}$: Normal Mode; I_{CHG} determined by R_{SET}
- ii. $V_{BAT} < V_{OUT} < V_{APM-REG}$: APM mode; $I_{CHG} = 450mA - I_{OUT}$
- iii. $V_{OUT} < V_{BAT}$: BAT supply mode

■ USB 100 MODE (MODE=LOW , ISET2=LOW)

- i. $V_{APM-REG} < V_{OUT}$: Normal Mode; I_{CHG} determined by R_{SET}
- ii. $V_{BAT} < V_{OUT} < V_{APM-REG}$: APM mode; $I_{CHG} = 90mA - I_{OUT}$
- iii. $V_{OUT} < V_{BAT}$: BAT supply mode

The active power management feature adjusts the charging current to resist the output voltage drop due to heavy system loading or insufficient input driving capability. In the extreme situation, the charging current flow would be reversed (the battery helps to supply the system power). The active power management regulation voltage $V_{APM-REG}$ is given by:

$$V_{APM-REG} = I_{APM-SET} \times R_{APM} \times SF^{(4)}$$

When the output voltage is higher than $V_{APM-REG}$, the input source is capable of providing the charging current (set by R_{SET}) and output current (determined by system loading) simultaneously. When the output voltage goes down and reaches $V_{APM-REG}$ due to an increasing loading, AUR9807 starts to reduce the charging current and tries to keep the output voltage at $V_{APM-REG}$. Because AUR9807 uses the remaining available current to charge the battery, the charging current can be estimated as $I_{supply\ max} - I_{OUT}$. In AC mode, the $I_{supply\ max}$ is determined by the driving capability of the AC adapter and AUR9807 itself (usually the limiting factor is the AUR9807, and $I_{supply\ max}$ is about 2A). The $I_{supply\ max}$ is determined by the ISET2 setting in USB mode ($I_{supply\ max}$ is about 450mA with ISET2 high, and $I_{supply\ max}$ is about 90mA with ISET2 low).

When the loading current keeps increasing and exceeds $I_{supply\ max}$, the AUR9807 can not prevent the output voltage dropping below $V_{APM-REG}$ even the charging current is reduced to zero. When the output voltage drops below the battery voltage, the battery helps to supply the loading current and keeps the output voltage roughly at V_{BAT} . At this situation, we have:

$$I_{OUT} = I_{supply\ max} + I_{BAT}^{(5)}$$

- (4) $R_{APM} < 38k\Omega$: $V_{APM-REG} = I_{APM-SET} \times R_{APM} \times SF$
 $R_{APM} > 41k\Omega$: The $V_{APM-REG}$ is set to a predetermined fixed value (4.26V)
- (5) $I_{BAT} = (V_{BAT} - V_{OUT}) / (40m\Omega \text{ Power Path Resistance})$

Battery Temperature Protection

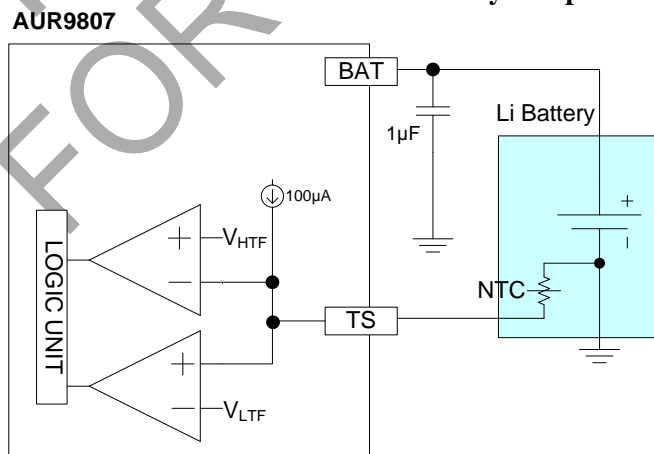

**Single-cell Li-Ion Charger IC with System Power Management AUR9807****Charge Function Descriptions (Continued)**

The AUR9807 interrupts the charging process when the battery temperature is out of normal range. It provides a 100 μ A sensing current to the negative-temperature coefficient resistor (on the battery side) through the TS pin. The battery protection is achieved by constantly monitoring the voltage at the TS pin. When this voltage is higher than V_{LTF} (nominally 2.5V) or lower than V_{HTF} (nominally 0.5V), an under-temperature or over-temperature condition is detected. For an usual 103AT-type NTC resistor, the corresponding temperature range is between 0 $^{\circ}$ C and 45 $^{\circ}$ C. The normal battery temperature range can be modified by adjusting the NTC resistor or by adding extra resistor network between the TS pin and the negative-temperature coefficient resistor. The charging process would resume after the battery temperature goes back within the normal range.

Charge Timeout Setting

The charge timeout setting is programmed by the resistor R_{TMR} connected between the TMR and ground pin. The timeout setting is given by:

$$t_{CHG} = K_{TMR} \times R_{TMR}$$

A suggested 36k Ω R_{TMR} gives a 3.6 hrs timeout setting because the nominal value of K_{TMR} is 0.36 sec/ Ω . In the actual charging process, the charging duration is elongated if the charging current can not reach the maximum current setting (again this relates to system loading and environment temperature); therefore, it is possible that the charging process is still on progress while the 3.6 hrs timeout limit has been reached. To circumvent this problem, the actual charging current is monitored and the clock rate of the timer counter is halved if the charging current is less than 50% of the maximum fast charging current. This is equivalent to modify the timeout setting temporarily by the following equation:

$$t_{CHG} = K_{EXT1} \times K_{TMR} \times R_{TMR}, \text{ where } K_{EXT1}=2$$

If the actual charging current is less than one fourth the maximum fast charging current, the time out counter rate is reduced to 25%. The temporary timeout setting is given by:

$$t_{CHG} = K_{EXT2} \times K_{TMR} \times R_{TMR}, \text{ where } K_{EXT2}=4$$

Once the abnormal condition is removed (high temperature or heavy loading), the charging current resumes the maximum values (set by R_{SET}), and the time out counter will operate in normal rate.

Charge Status Indicator

Status	STAT1	STAT2
Pre-charge	ON	ON
Constant current and constant voltage charge	ON	OFF
Charge done	OFF	ON
Fault condition (time out, sleep mode, or OTP)	OFF	OFF

The open drain pins STAT1 and STAT2 provides the information about the charger status when the CE pin (chip enable) is set to high. The various charger status and the corresponding STAT1 and STAT2 levels are given in the above Table. Connect these pins to the host processor or LEDS to indicate the charger status.

Short Circuit Protection

AUR9807 provides short circuit protection for both the input and the battery. When V_{IN} is larger than V_{BAT} , AC adapter (or USB port) is chosen as the power source. If the output voltage is lower than 1V ($V_{OUT(SC1)}$) for more than $t_{DGL(SC)}$, a short circuit condition is detected; the power path between the input and the output will be cut off. The charging process will be interrupted. A 500 Ω resistor is used to pull up the output voltage; if the load at the output is removed, the output voltage can be pulled up and the short circuit condition is dissolved.

Similarly, when the battery is chosen as the power source, an output voltage lower than the battery voltage by 200mV ($V_{OUT(SC2)}$) longer than $t_{DGL(SC)}$ will trigger the short circuit protection mechanism (this corresponds to a 5A loading current). A 10mA current source is used to pull up the output and detect the removal of the short condition. The power consumption is less than 5 μ A under the battery supply mode; however, AUR9807 is still able to monitor the output voltage and detect a short circuit condition with this limiting current budget.

SYSOFF Function

The SYSOFF function is used to cut off the power path between the battery and the output. This means the

**Single-cell Li-Ion Charger IC with System Power Management AUR9807****Charge Function Descriptions (Continued)**

charger function can be disabled by pulling up the SYSOFF pin; in this mode, the AUR9807 is almost a regulator to power the system. Because the power path is cut off, the output voltage will drop to zero when the input source is removed, the battery will not be used to power the system. The SYSOFF pin is pulled high internally; therefore, this pin should be pulled to ground for normal operation.

Recharge Process and Timer Fault Elimination

If timeout occurs and the battery voltage is higher than the recharge threshold, the charger will stay in the charge done mode until the battery voltage drops below the recharge threshold. Once the battery voltage drops below the recharge threshold, a new

charge cycle starts.

If timeout occurs and the battery voltage is lower than the recharge threshold, the charger will indicate a fault condition and an internal resistor between output and battery will try to pull up the battery voltage. If the internal resistor is unable to pull up the battery voltage to the recharge threshold, the charger will stay in fault condition. Once the battery voltage is higher than the recharge threshold, the charger removes the pull-up resistor, leaves the fault condition and stay in the charge done mode temporarily. The charger then waits the battery voltage to drop below the recharge threshold and starts a new charge cycle.



Single-cell Li-Ion Charger IC with System Power Management AUR9807

PC Board Layout Considerations

It is important to pay special attention to the PCB layout. The following provides some guidelines.

1. To obtain optimal performance, the decoupling capacitor from the input terminal to GND and the output filter capacitor from OUT to GND should be placed as close as possible to the AUR9807, with short trace runs to both signal and GND pins.
2. All low-current GND connections should be kept

separate from the high-current charge or discharge paths from the battery. Use a single-point ground technique incorporating both the small signal ground path and the power ground path.

3. The high-current charge paths into IN and from the BAT and OUT pins must be sized appropriately for the maximum charge current in order to avoid voltage drops in these traces.

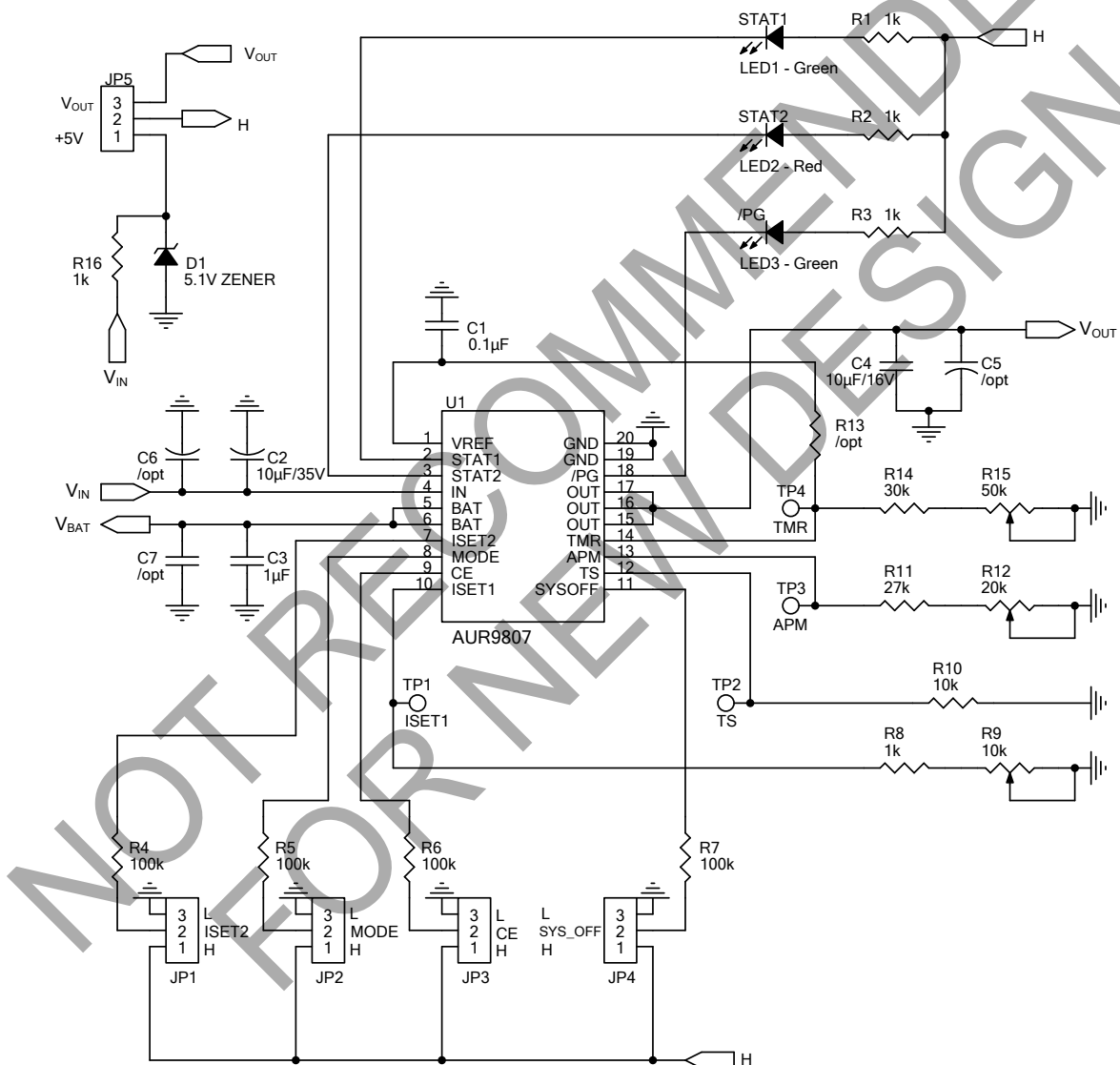

Figure 13. The Evaluation Board Schematic

Single-cell Li-Ion Charger IC with System Power Management AUR9807

PC Board Layout Considerations (Continued)

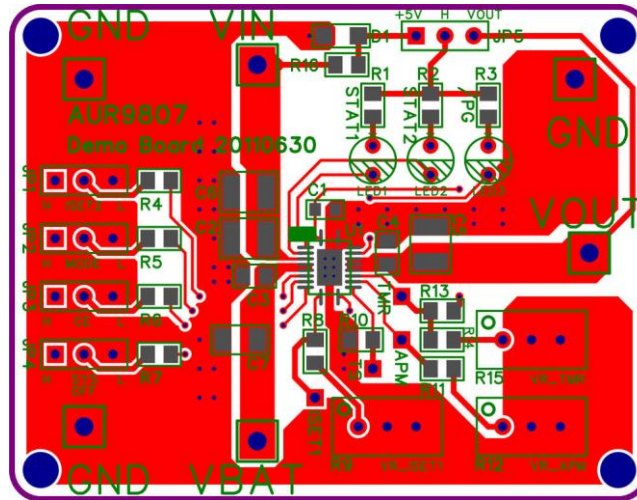

Figure 14. Top Side View of The Evaluation Board

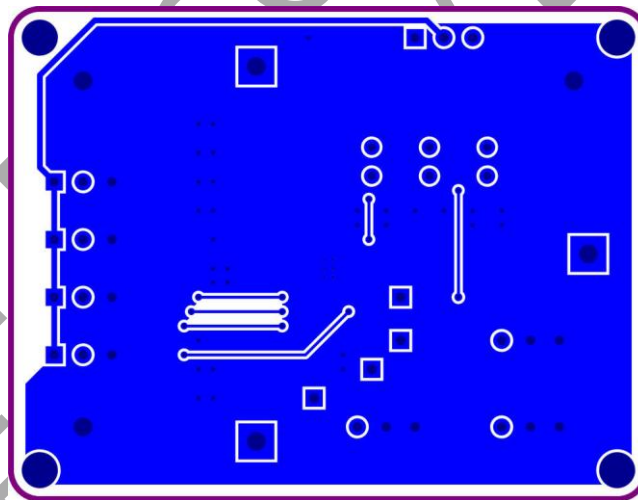

Figure 15. Bottom Side View of The Evaluation Board

Single-cell Li-Ion Charger IC with System Power Management AUR9807

Typical Application

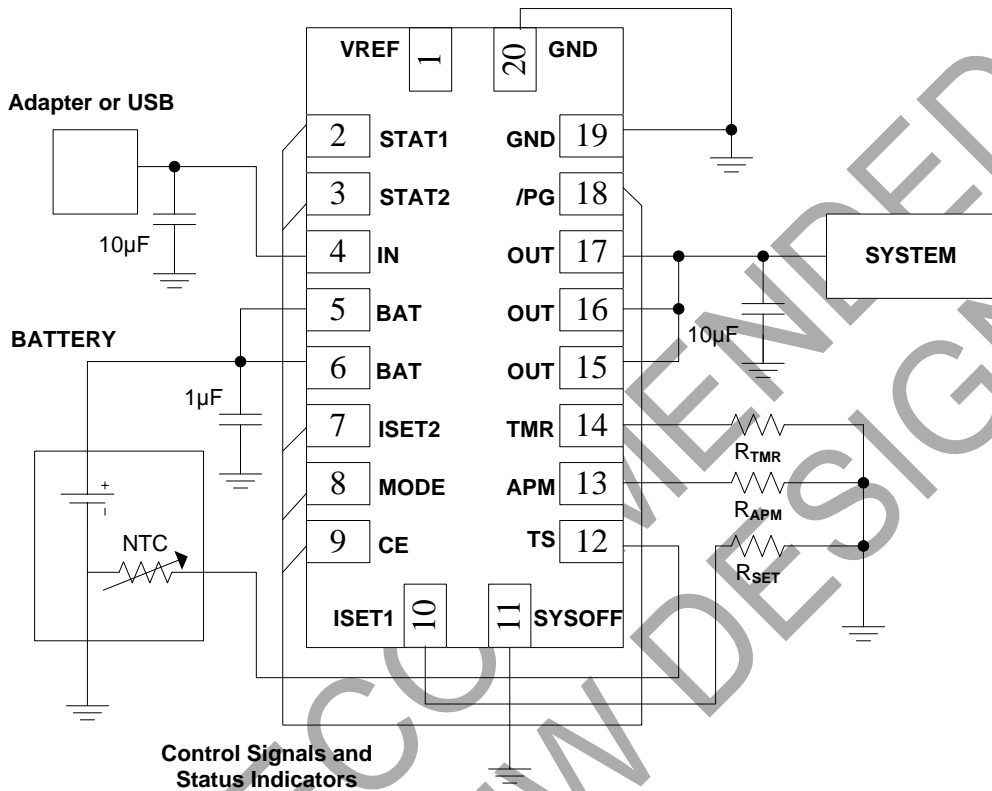

Figure 16. Typical Application of AUR9807



Single-cell Li-Ion Charger IC with System Power Management AUR9807

Mechanical Dimensions

QFN-4.5x3.5-20

Unit: mm(inch)

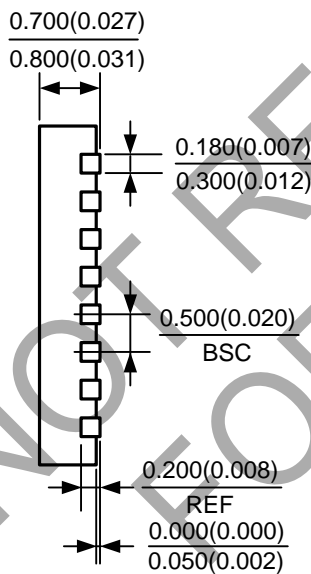
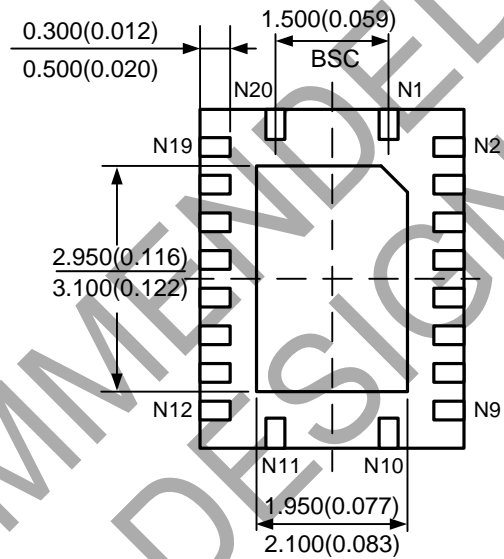
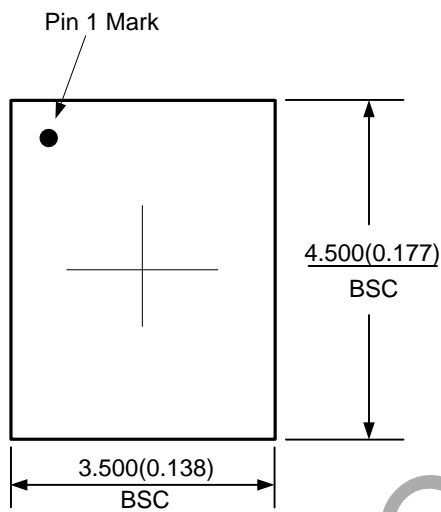



BCD Semiconductor Manufacturing Limited

<http://www.bcdsemi.com>

IMPORTANT NOTICE

BCD Semiconductor Manufacturing Limited reserves the right to make changes without further notice to any products or specifications herein. BCD Semiconductor Manufacturing Limited does not assume any responsibility for use of any its products for any particular purpose, nor does BCD Semiconductor Manufacturing Limited assume any liability arising out of the application or use of any its products or circuits. BCD Semiconductor Manufacturing Limited does not convey any license under its patent rights or other rights nor the rights of others.

MAIN SITE

- Headquarters

BCD (Shanghai) Micro-electronics Limited

No. 1600, Zi Xing Road, Shanghai ZiZhu Science-based Industrial Park, 200241, P. R. C.
Tel: +86-021-2416-2266, Fax: +86-021-2416-2277

- Wafer Fab

Shanghai SIM-BCD Semiconductor Manufacturing Co., Ltd.

800 Yishan Road, Shanghai 200233, China
Tel: +021-6485-1491, Fax: +86-021-5450-0008

REGIONAL SALES OFFICE

Shenzhen Office

Shanghai SIM-BCD Semiconductor Manufacturing Co., Ltd., Shenzhen Office

Unit A Room 1203, Skyworth Bldg., Gaoxin Ave.1.S., Nanshan District
Shenzhen 518057, China

Tel: +86-0755-8660-4900, Fax: +86-0755-8660-4958

Taiwan Office (Taipei)

BCD Semiconductor (Taiwan) Company Limited

3F, No.17, Lane 171, Sec. 2, Jiu-Zong Rd., Nei-Hu Dist., Taipei(114), Taiwan, R.O.C
Tel: +886-2-2656-2808

Fax: +886-2-2656-2806/26562950

Taiwan Office (Hsinchu)

BCD Semiconductor (Taiwan) Company Limited

8F, No.176, Sec. 2, Gong-Dao 5th Road, East District
HsinChu City 300, Taiwan, R.O.C

Tel: +886-3-5160181, Fax: +886-3-5160181

USA Office

BCD Semiconductor Corp.

48460 Kato Road, Fremont, CA 94538, USA
Tel: +1-510-668-1950

Fax: +1-510-668-1990

Korea Office

BCD Semiconductor Limited Korea office.

Room 101-1112, Digital-Empire II, 486 Sin-dong,
Yeongtong-Gu, Suwon-city, Gyeonggi-do, Korea

Tel: +82-31-695-8430