

General Description

The Micrel MIC79110 is a simple and accurate lithium-ion battery charger. The part features a built-in pass transistor, precision programmable current limiting ($\pm 5\%$), and precision voltage termination ($\pm 0.75\%$ over temperature). The MIC79110 packs full functionality into a small space.

Other features of the MIC79110 include two independent indicators: a digital end-of-charge signal that is programmable with a resistor-to-ground and an analog current output that is proportional to the output current, allowing for monitoring of the actual charging current. Additional features include very low dropout (550mV over the temperature range), thermal shutdown, and reverse polarity protection. In the event the input voltage to the charger is disconnected, the MIC79110 also provides minimal reverse-current and reversed-battery protection.

Available in both fixed 4.2V and adjustable outputs, the MIC79110 is offered in the leadless 10-pin 3mm \times 3mm DFN with an operating junction temperature range of -40°C to $+125^\circ\text{C}$.

Datasheets and support documentation are available on Micrel's web site at: www.micrel.com.

Features

- Input voltage range: 2.5V to 16V
- High output voltage accuracy of $\pm 0.75\%$ over -5°C to $+60^\circ\text{C}$
- Current limit $\pm 5\%$ accurate from $-5^\circ\text{C} \leq T_J \leq +125^\circ\text{C}$
- Programmable end-of-charge flag
- Analog output proportional to output current
- Adjustable and fixed 4.2V output
- Low dropout voltage of 550mV at 700mA load, over temperature
- 1.2A maximum charge current
- Excellent line and load regulation specifications
- Reverse-current protection
- Thermal-shutdown and current-limit protection
- Tiny 10-pin 3mm \times 3mm DFN package
- Junction temperature range: -40°C to $+125^\circ\text{C}$

Applications

- Cellular phones and PDAs
- Digital cameras and camcorders
- MP3 players
- Notebook PCs
- Portable Meters
- Cradle/car chargers, and battery packs

Typical Application

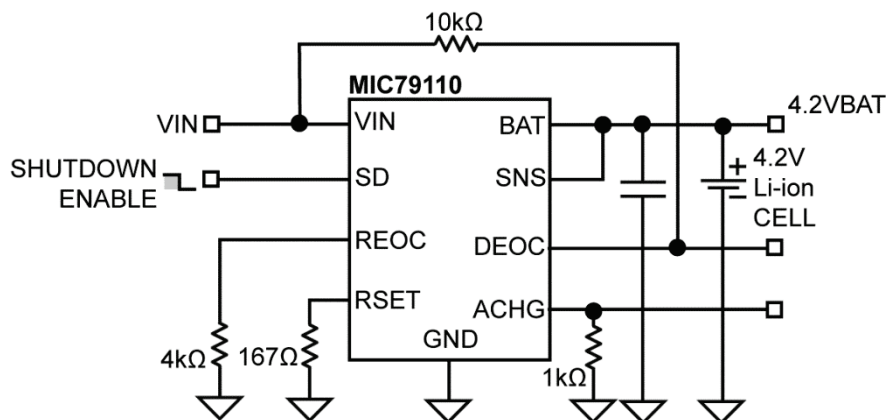

Ordering Information

Part Number	Marking Code ⁽¹⁾	Voltage	Junction Temperature Range	Package
MIC79110-4.2YML	L942	4.2V	-40° to +125°C	10-Pin 3mm × 3mm DFN
MIC79110YML	L9AA	Adjustable	-40° to +125°C	10-Pin 3mm × 3mm DFN

1. Pb-Free "Y" indicator is added to the device mark after logo.

Pin Configuration

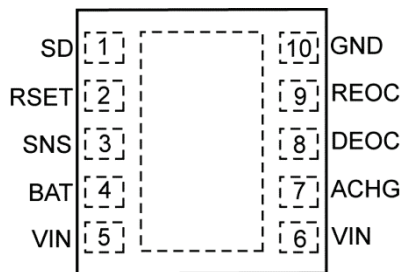

Fixed Output
10-Pin 3mm × 3mm DFN (ML)

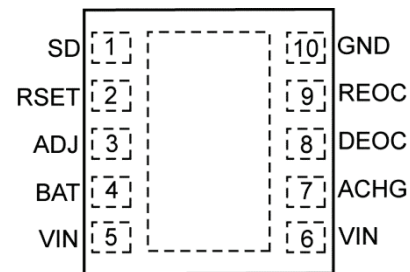

Adjustable Output
10-Pin 3mm × 3mm DFN (ML)

Pin Description

Pin Number	Pin Name	Pin Function
1	SD	Shutdown Input. Logic HIGH = Off; Logic LOW = On.
2	RSET	Current limit: Sets constant current limit via an external resistor to ground. $I_{RSET} = (0.2V/R_{SET}) \times 1000$.
3	SNS	(Fixed voltage only): Sense output, connect directly to battery.
3	ADJ	(Adjustable voltage only): Feedback input.
4	BAT	Battery Terminal. Connect to single-cell lithium-ion battery.
5, 6	VIN	Input supply pin.
7	ACHG	Analog Charge Indicator Output: Current source who's output current is equal to 1/1000 of the BAT pin current.
8	DEOC	Digital End-of-Charge Output: N-Channel open-drain output. LOW indicates charging, a current that is higher than the programmed current set by R_{EOC} is charging the battery. When the current drops to less than the current set by R_{EOC} , the output goes high impedance, indicating end-of-charge.
9	REOC	End-of-Charge Set: Sets end-of-charge current threshold via an external resistor to ground. $I_{EOC} = (0.2V/R_{EOC}) \times 1000$.
10	GND	Ground

Absolute Maximum Ratings⁽²⁾

Input Supply Voltage (V_{IN})	0V to 18V
Shutdown Input Voltage (V_{SD})	0V to 10V
Output Voltage (ADJ)	10V
Power Dissipation	Internally Limited
Junction Temperature	-40°C to +125°C

Operating Ratings⁽³⁾

Input Supply Voltage	2.5V to 16V
Shutdown Input Voltage (V_{SD})	0V to 7V
Output Voltage (ADJ)	9.6V
Junction Temperature Range (T_J)	-40°C to +125°C
3mm × 3mm DFN-10 (θ_{JA})	60°C
3mm × 3mm DFN-10 (θ_{JC})	2°C

Electrical Characteristics⁽⁴⁾

$T_A = 25^\circ\text{C}$ with $V_{IN} = V_{OUT} + 1\text{V}$; $I_{LOAD} = 100\mu\text{A}$; $C_{BAT} = 10\mu\text{F}$; $SD = 0\text{V}$; $R_{SET} = 1\text{k}\Omega$. **Bold** values indicate $-40^\circ\text{C} < T_J < +125^\circ\text{C}$; unless otherwise specified.

Parameter	Condition	Min.	Typ.	Max.	Units
Output Voltage Accuracy	$V_{OUT} = 4.2\text{V}$; $I_{LOAD} = 50\text{mA}$; $T_J = -5^\circ\text{C}$ to $+60^\circ\text{C}$	-0.75		+0.75	%
	$V_{OUT} = 4.2\text{V}$; $I_{LOAD} = 50\text{mA}$; $T_J = -40^\circ\text{C}$ to $+125^\circ\text{C}$	-1.5		+1.5	
ADJ Pin Voltage Accuracy		0.5955	0.6	0.6045	V
Line Regulation	$V_{IN} = V_{OUT} + 1\text{V}$ to 16V @ $I_{LOAD} = 50\text{mA}$	-0.1		+0.1	%/V
Load Regulation	$I_{LOAD} = 0.1\text{mA}$ to 1A		0.3		%
Dropout Voltage ⁽⁵⁾	$I_{LOAD} = 100\text{mA}$, $R_{SET} = 167\Omega$		160	250	mV
	$I_{LOAD} = 700\text{mA}$, $R_{SET} = 167\Omega$		375	550	mV
Ground Current	$I_{LOAD} = 10\text{mA}$, $R_{SET} = 167\Omega$		2	3	mA
	$I_{LOAD} = 700\text{mA}$, $R_{SET} = 167\Omega$		24	35	mA
VIN Pin Current	$SD = V_{IN}$		120	300	μA
Shutdown Pin Current	$SD = 5.2\text{V}$, $V_{BAT} = 0$		0.1	5	μA
Shutdown Input Threshold	Logic High, regulator off	1.05			V
	Logic Low, regulator on			0.93	V
Shutdown Hysteresis			60		mV
Current Limit Accuracy ^(6, 7)	$V_{OUT} = 0.9 \times V_{NOM}$; $I_{OUT} = 1.2\text{A}$, $R_{SET} = 167\Omega$, $T_J = -40^\circ\text{C}$ to $+85^\circ\text{C}$	-5		+5	%
	$V_{OUT} = 0.9 \times V_{NOM}$; $I_{OUT} = 0.1\text{A}$, $R_{SET} = 2\text{k}\Omega$	-20		+20	%
Current-Limit Setpoint Range ⁽⁷⁾		0.1		1.2	A

Notes:

- Exceeding the absolute maximum rating may damage the device.
- The device is not guaranteed to function outside its operating rating.
- Specification for packaged product only.
- Dropout voltage is defined as the input to output differential at which the output voltage drops 2% below its nominal value measured at 1V differential. For outputs below 2.5V, dropout voltage is the input-to-output voltage differential with the minimum input voltage 2.5V. Minimum input operating voltage is 2.5V.
- V_{NOM} denotes the nominal output voltage.
- $I_{RSET} = (0.2\text{V}/R_{SET}) \times 1000$.

Electrical Characteristics⁽⁴⁾ (Continued)

$T_A = 25^\circ\text{C}$ with $V_{IN} = V_{OUT} + 1\text{V}$; $I_{LOAD} = 100\mu\text{A}$; $C_{BAT} = 10\mu\text{F}$; $SD = 0\text{V}$; $R_{SET} = 1\text{k}\Omega$. **Bold** values indicate $-40^\circ\text{C} < T_J < +125^\circ\text{C}$; unless otherwise specified.

Parameter	Condition	Min.	Typ.	Max.	Units
Maximum Current Limit	R_{SET} shorted to ground, $V_{BAT} = 0.9 \times V_{NOM}$	1.25	1.65	2.5	A
V_{BAT} Reverse Current	$V_{IN} = \text{High impedance or ground}$		4.2	20	μA
Digital End-of-Charge (DEOC) Output					
$I_{EOC}^{(8,9)}$	$R_{EOC} = 4\text{k}\Omega$ Current Falling	35	50	65	mA
		30		70	
$I_{EOC}^{(8,9)}$	$R_{EOC} = 4\text{k}\Omega$ Current Rising	50	70	95	mA
		40		100	
D_{EOC} Logic-Low Voltage	$I_{EOC} = 5\text{mA}$, $I_{BAT} = 700\text{mA}$		0.74	0.95	V
D_{EOC} Leakage Current	Logic HIGH = $V_{IN} = 16\text{V}$		0.1		μA
D_{EOC} On Resistance	$V_{IN} = +5\text{V}$		150	190	Ω
R_{EOC} Maximum Current Limit	R_{EOC} shorted to ground	0.5	1.0	2.0	mA
Analog Charge Indicator (ACHG) Output					
$I_{SOURCE}^{(10)}$	$I_{BAT} = 50\text{mA}$	37	46	55	μA
	$I_{BAT} = 1.2\text{A}$, $T_J = -40^\circ\text{C}$ to $+85^\circ\text{C}$	800	950	1150	

Notes:

- Output current I_{EOC} when digital end-of-charge output goes high impedance. Currents greater than I_{EOC} , the DEOC output is low, currents lower than I_{EOC} , DEOC is high impedance.
- $I_{EOC} = (0.2\text{V}/R_{EOC}) \times 1000$.
- I_{SOURCE} is the current output from ACHG pin. A resistor to ground from the ACHG pin will program a voltage that is proportional to the output current.

Typical Characteristics

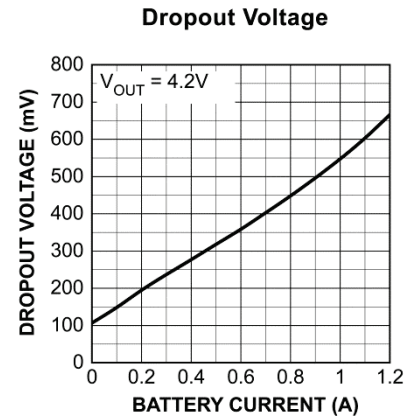
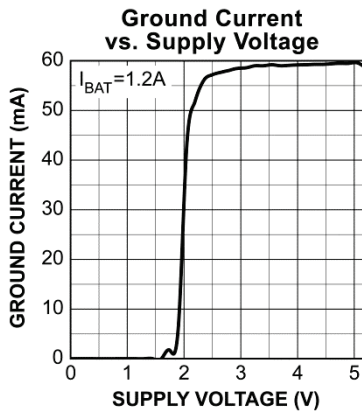
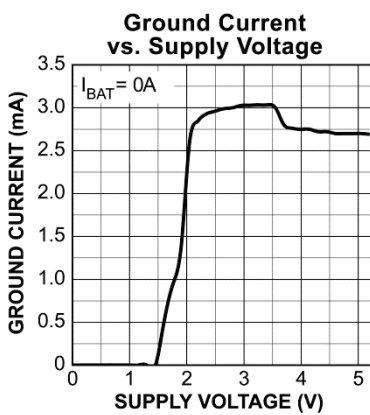
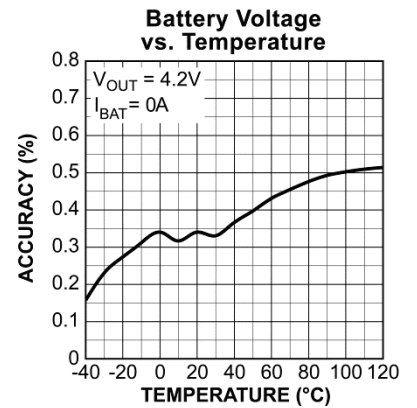
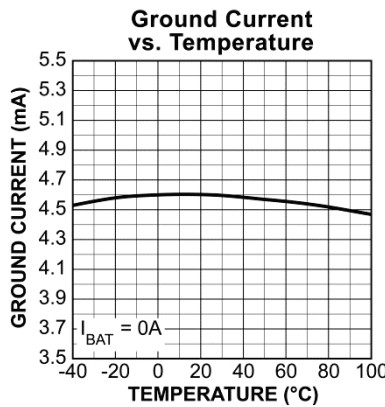
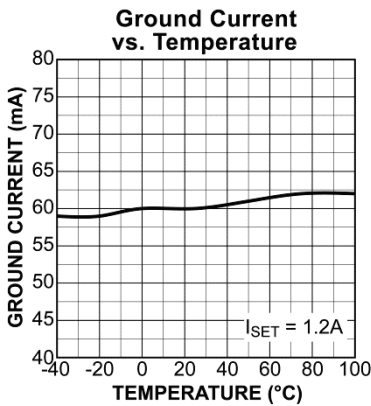
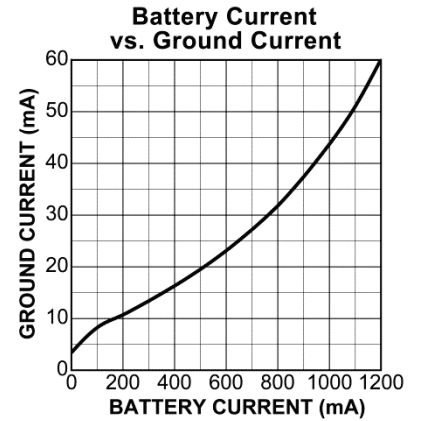
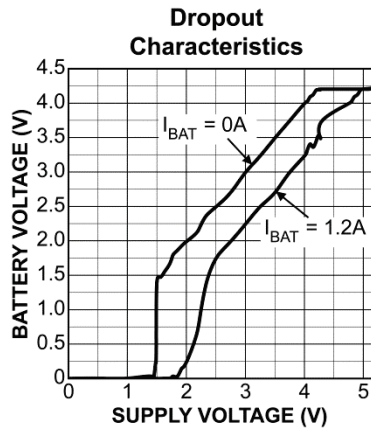
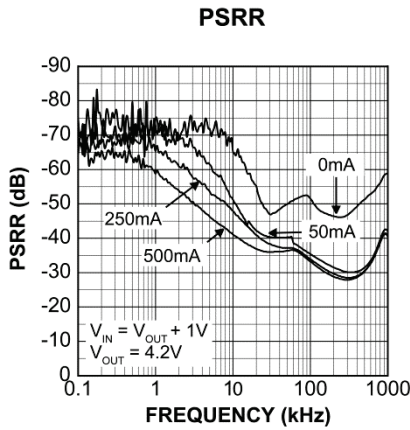

Typical Characteristics (Continued)

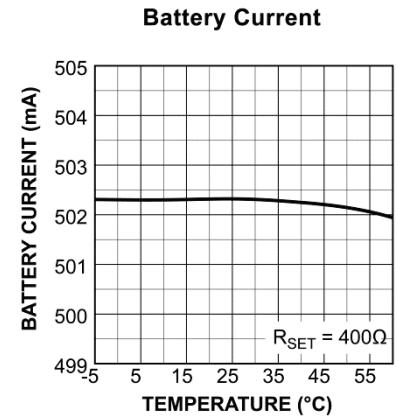
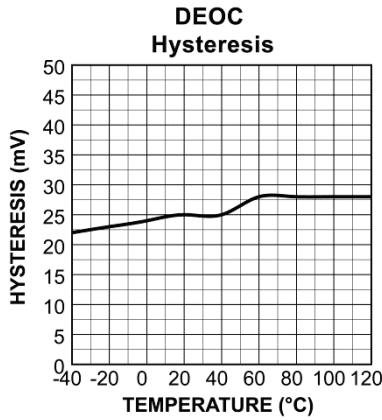
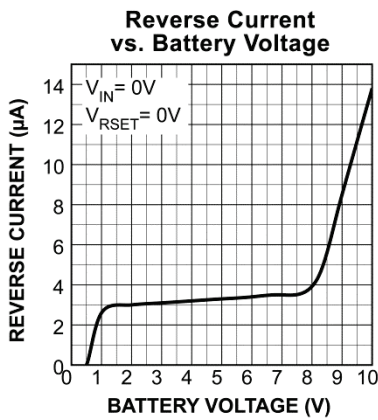
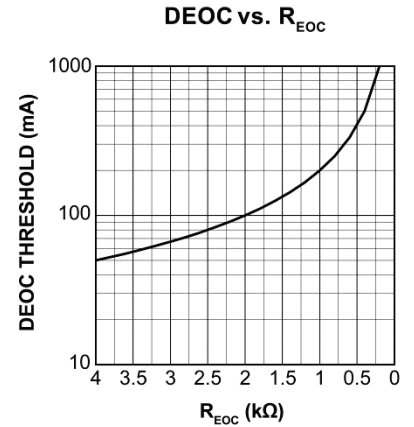
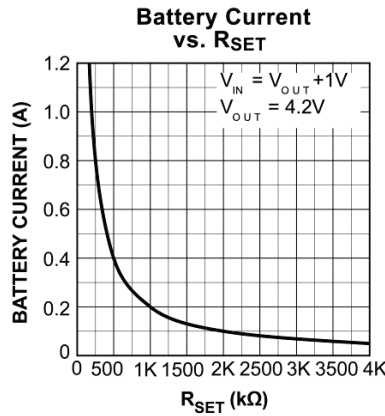
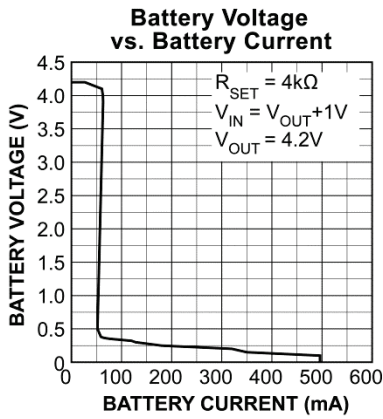
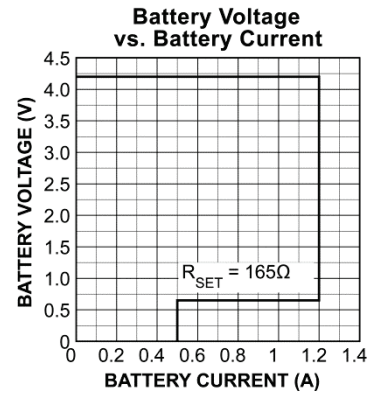
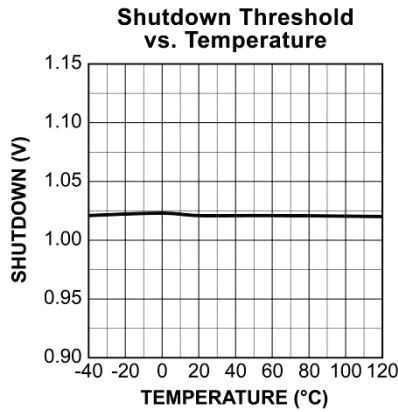
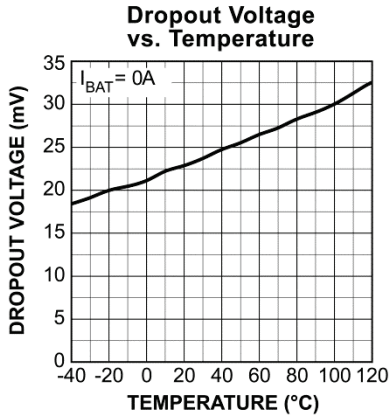

Typical Characteristics (Continued)

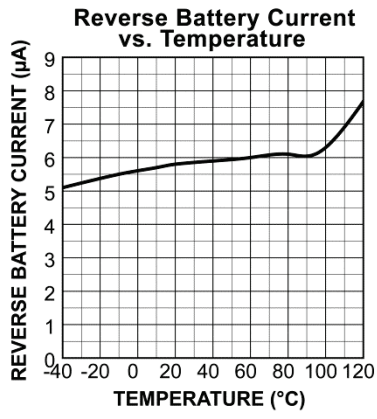

Functional Characteristics

Line Transient

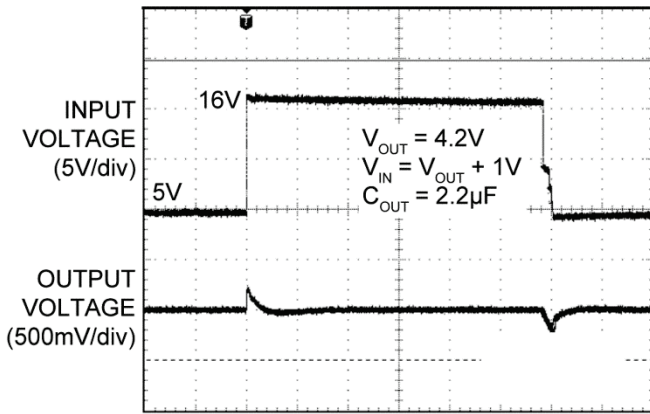

Time (20µs/div)

Load Transient

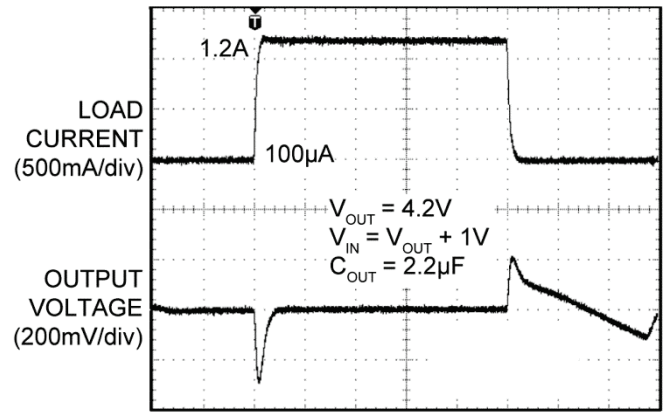

Time (100µs/div)

Shutdown Transient

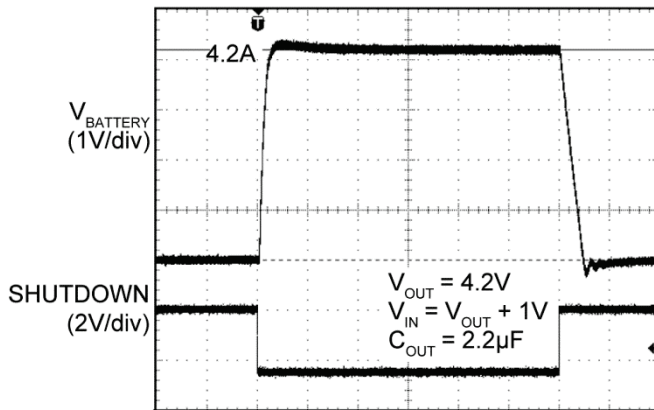

Time (100µs/div)

Battery Current Enable Transient

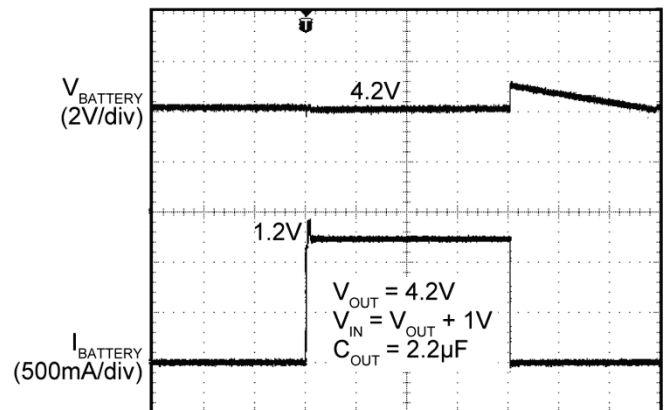

Time (1ms/div)

Flow Chart

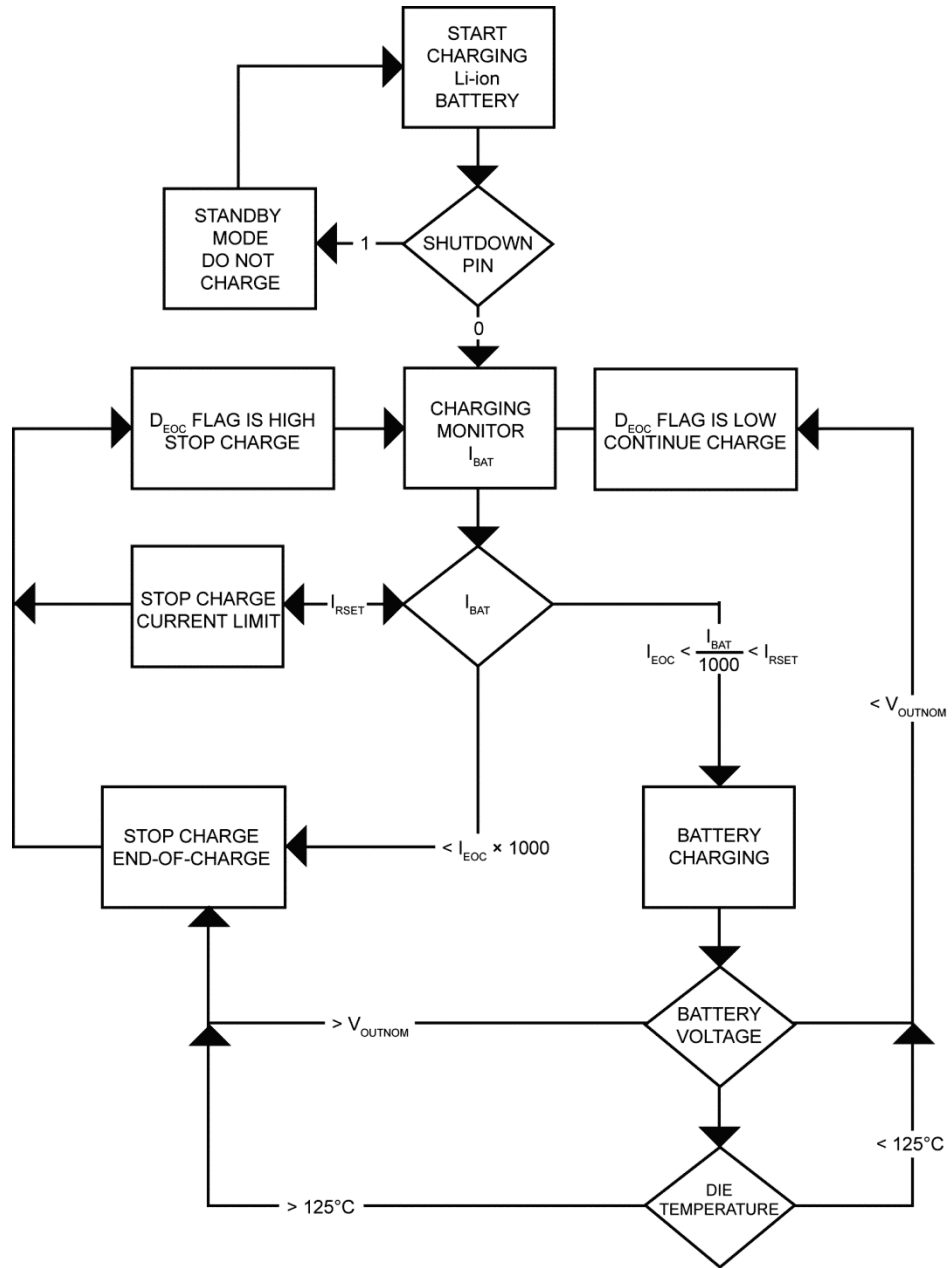

Application Information

Detailed Description

The MIC79110 forms a complete charger for 1-cell lithium-ion batteries. It includes precision voltage control (0.75% over temperature) to optimize both cell performance and cycle life. All are compatible with common 4.2V lithium-ion chemistries. Voltages other than 4.2V can be obtained with the adjustable version. Other features include current limit, end-of-charge flag, and end-of-charge current limit using an external resistor. The shutdown pin enables low quiescent current when not charging.

Current-Limit Mode

MIC79110 features an internal current limit that is set by the RSET pin with a resistor-to-ground. The maximum current is calculated by Equation 1:

$$I_{RSET} = (0.2/R_{SET}) \times 1000 \quad \text{Eq. 1}$$

Using a 167 Ω RSET resistor will achieve the maximum current limit for the MIC79110 at 1.2 amperes.

End-of-Charge

REOC pin is connected to a resistor-to-ground. This resistor is used to set the end of charge current for the lithium-ion battery as in Equation 2:

$$I_{EOC} = (0.2/R_{EOC}) \times 1000 \quad \text{Eq. 2}$$

Using a 4k Ω R_{EOC} resistor will set the end-of-charge current at 50mA.

I_{EOC} should be set at 10% of the battery's rated current.

Digital End-of-Charge Output

This pin is the output of an open drain. When tied high to the supply using a resistor, the output will toggle high or low depending on the output current of I_{BAT}.

- Low state indicates that the I_{BAT} current is higher than the programmed current set by R_{EOC}.
- High state indicates that the I_{BAT} current is lower than the programmed current set by R_{EOC}. The output goes high impedance indicating end-of-charge.

Analog End-Of-Charge Output

The ACHG pin provides a small current that is proportional to the charge current. The ratio is set at 1/1000th of the output current.

Shutdown

The SD pin serves as a logic input (active low) to enable the charger.

Built-in hysteresis for the shutdown pin is 50mV over temperature.

Reverse Polarity Protection

In the event that V_{BAT} > V_{IN} and the shutdown pin is active low, there is reverse battery current protection built in. The current is limited to less than 10 μ A over temperature.

Constant Output Voltage/Current Charging

The MIC79110 features constant voltage and constant current output to correctly charge lithium-ion batteries. The constant voltage is either 4.2V or adjustable. The constant current is set by the R_{SET} pin and is constant down to around 300mV. Since R_{SET} can be set below 500mA, the minimum output current is set at 500mA for output voltages below 100mV. This minimum voltage starts the charging process in lithium-ion batteries. If the output current is too low, the battery will not begin charge.

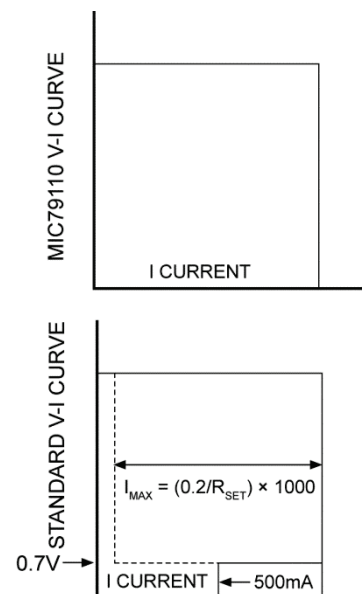

Figure 1. MIC79110 Constant Output Voltage

Lithium-ion Batteries

Lithium-ion batteries are charged in two stages to reach full capacity. The first stage charges the battery with maximum charge current until 90% of the battery cell's voltage limit is reached. The second stage tops off the charge with constant voltage charge as the charge current slowly decreases. End of charge is reached when the current is less than 3% of the rated current. A third stage will occasionally top off with charge with constant voltage charge if the battery voltage drops below a certain threshold.

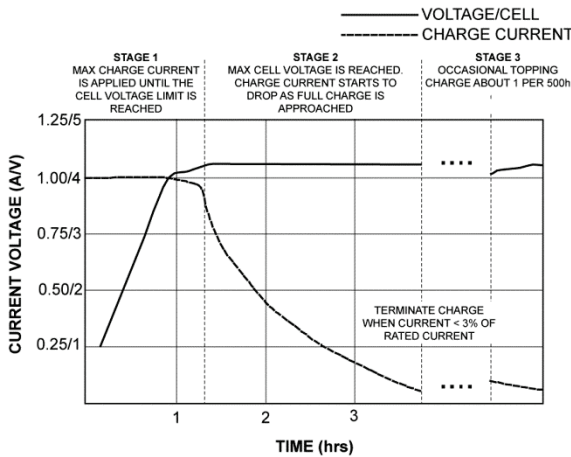

Figure 2. Typical Two-Stage Lithium Charge Profile

All lithium-ion batteries take approximately 3 hours to charge with the second stage taking twice as long as the first stage. Some chargers claim to be fast chargers by skipping the second stage and just charges the battery until the cell voltage is reached. This only charges the battery to 70% capacity.

An increase in the charge current during stage 1 does not shorten the total charge time. It will only shorten the time for stage 1 to complete and lengthen the time in stage 2.

The lithium-ion loses charge due to aging whether it is used or not. Do not store the batteries at full charge and high heat because it will accelerate the aging process. Try and store with 40% charge and in a cool environment.

Lithium-ion Safety Precautions

Every lithium-ion battery pack should have a safety circuit which monitors the charge and discharge of the pack and prevents dangerous occurrences.

The specifications of these safety circuits are dictated by the cell manufacturer and may include the following:

- Reverse polarity protection.
- Charge temperature must not be charged when temperature is lower than 0°C or above 45°C.
- Charge current must not be too high, typically below 0.7°C.
- Discharge current protection to prevent damage due to short circuits.
- Protection circuitry for over voltage applied to the battery terminals.
- Overcharge protection circuitry to stop charge when the voltage per cell rises above 4.3V.
- Over discharge protection circuitry to stop discharge when the battery voltage falls below 2.3V (varies with manufacturer).
- Thermal shutdown protection for the battery if the ambient temperature is above 100°C.

Auto Top-Off Charger Application Circuit

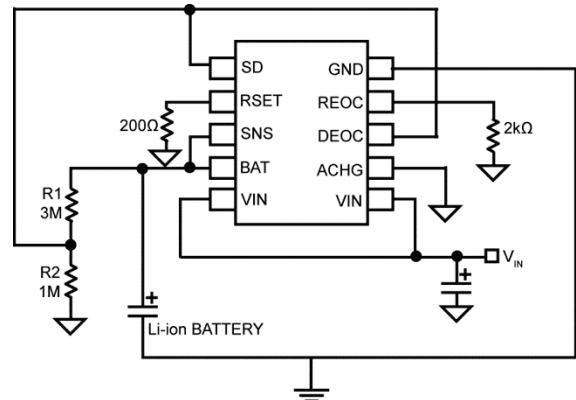

Figure 3. Auto Top-Off Charger – Application Circuit

Lithium-ion batteries will begin to lose their charge over time. The MIC79110 can be configured to automatically recharge the battery when the voltage drops below the minimum battery voltage. This minimum voltage is set by a resistor divider at the battery and is connected to the SD pin. For instance, if V_{BAT} is 4.2V and the battery voltage falls to 3.72V, SD pin gets divided down by R1 and R2 to 0.93V and starts the normal charging process. While charging the DEOC indicator is turned on, pulling the SD pin to GND, keeping the MIC79110 on. When the end of charge is reached, the DEOC pin opens. The divided down BAT voltage is now 1.05V at the SD pin, ending the charging process.

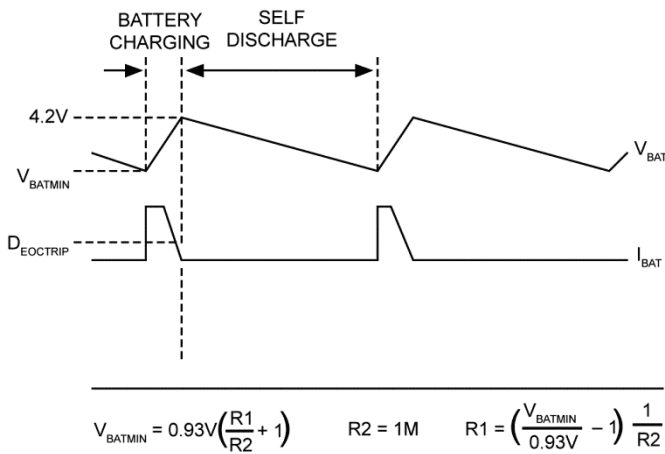

Figure 4. Auto Top-Off Charger Application

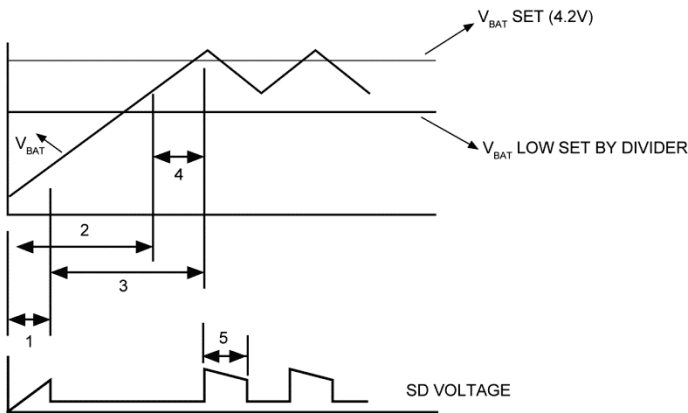

Figure 5. Charging Description

1. SD not held low by active high DEOC because DEOC Comparator's inputs do not common-mode to ground. Divider holds SD low so part can start.
2. SD held low by divider.
3. SD held low by active high DEOC.
4. Divider voltage above SD threshold and DEOC open.
5. Divider voltage drops below SD threshold and charging begins again.

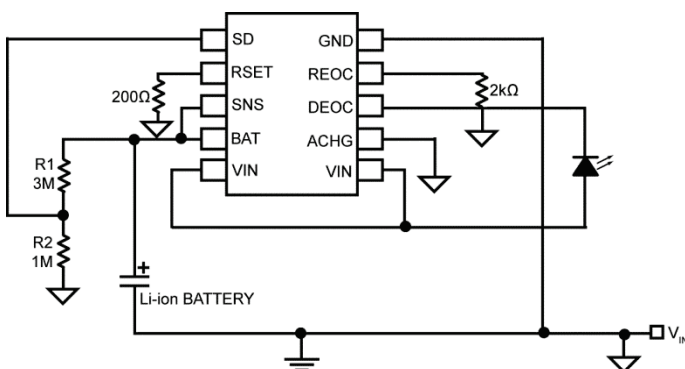

Figure 6. Top-Off Charger with Internal Reset – Application Circuit

This circuit is similar to the auto top-off charger circuit mentioned above except that the DEOC pin is externally triggered to restart the charging cycle. It still uses the same resistor divider to set the minimum battery voltage before the lithium-ion needs to be recharged.

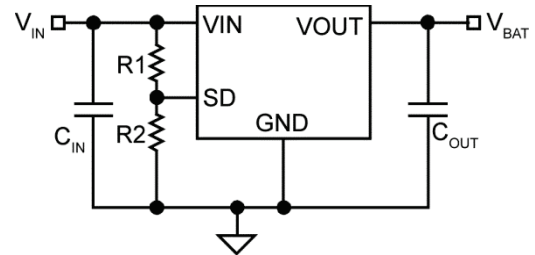

Figure 7. Auto-Shutdown using Shutdown Pin

The shutdown pin on the MIC79110 can be used to automatically shutdown the battery charger when the input voltage rises above a safe operating voltage. To keep the part from heating up and entering thermal shutdown, we can connect the shutdown pin to VIN using a resistor divider. Use Equation 3 to setup the maximum VIN:

$$\frac{VIN(MAX)}{V_{SD}} = \frac{R1}{R2} + 1 \tag{Eq. 3}$$

The MIC79110 can be connected to a wall wart with a rectified DC voltage and protected from over voltages at the input.

Package Information⁽¹¹⁾ and Recommended Landing Pattern

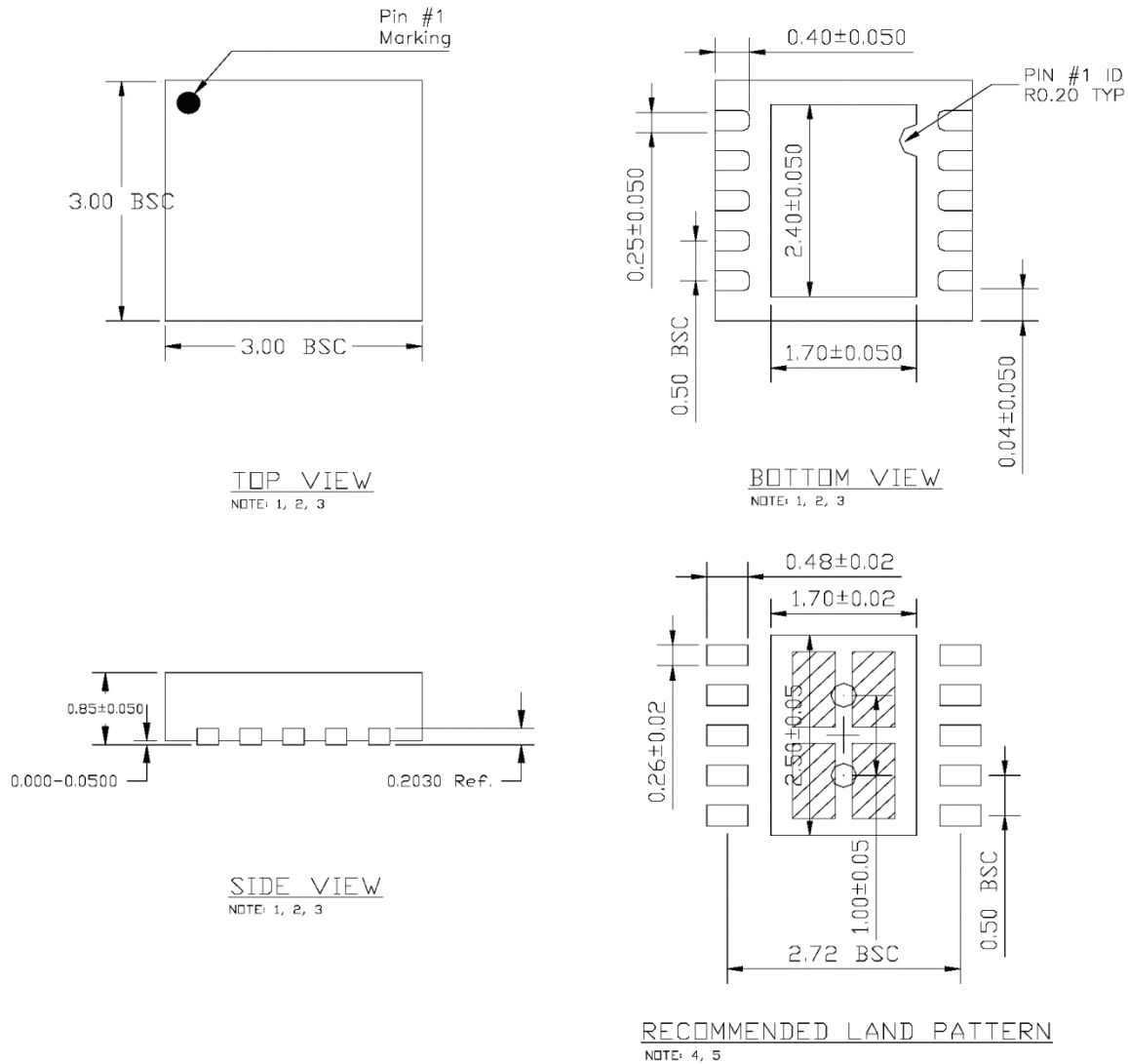

NOTE:

1. MAX PACKAGE WARPAGE IS 0.05 MM
2. MAX ALLOWABLE BURR IS 0.076MM IN ALL DIRECTIONS
3. PIN #1 IS ON TOP WILL BE LASER MARKED
4. RED CIRCLE IN LAND PATTERN INDICATE THERMAL VIA. SIZE SHOULD BE 0.30-0.3M IN DIAMETER AND SHOULD BE CONNECTED TO GND FOR MAX THERMAL PERFORMANCE
5. GREEN RECTANGLES (SHADED AREA) indicate SOLDER STENCIL OPENING ON EXPOSED PAD AREA. SIZE SHOULD BE 0.50x0.95 MM IN SIZE, 0.20 MM SPACING.

10-Pin 3mm x 3mm DFN (MM)

Note:

11. Package information is correct as of the publication date. For updates and most current information, go to www.micrel.com.

MICREL, INC. 2180 FORTUNE DRIVE SAN JOSE, CA 95131 USA
TEL +1 (408) 944-0800 FAX +1 (408) 474-1000 WEB <http://www.micrel.com>

Micrel makes no representations or warranties with respect to the accuracy or completeness of the information furnished in this data sheet. This information is not intended as a warranty and Micrel does not assume responsibility for its use. Micrel reserves the right to change circuitry, specifications and descriptions at any time without notice. No license, whether express, implied, arising by estoppel or otherwise, to any intellectual property rights is granted by this document. Except as provided in Micrel's terms and conditions of sale for such products, Micrel assumes no liability whatsoever, and Micrel disclaims any express or implied warranty relating to the sale and/or use of Micrel products including liability or warranties relating to fitness for a particular purpose, merchantability, or infringement of any patent, copyright or other intellectual property right.

Micrel Products are not designed or authorized for use as components in life support appliances, devices or systems where malfunction of a product can reasonably be expected to result in personal injury. Life support devices or systems are devices or systems that (a) are intended for surgical implant into the body or (b) support or sustain life, and whose failure to perform can be reasonably expected to result in a significant injury to the user. A Purchaser's use or sale of Micrel Products for use in life support appliances, devices or systems is a Purchaser's own risk and Purchaser agrees to fully indemnify Micrel for any damages resulting from such use or sale.

© 2013 Micrel, Incorporated.

Revision History

Date	Change Description/Edits by:	Rev.
05/21/13	Original DS edited and reflowed with applied edits – S. Thompson	2.0