

FEATURES

- Encapsulated lithium energy cell with shelf life beyond 10 years
- Available with energy capacities of 250, 500, and 1,000 mAH @ 3 volts
- Plugs into a standard 16-pin DIP socket
- Lithium cell electrically disconnects from exposed pins upon command
- Battery isolation ensures full capacity after shipping and handling
- Lithium cell automatically reconnects when V_{CC} is applied
- Recessed pins prevent bending
- V_{CC} fail signal interrupts processor or write-protects memory
- Exhausted energy cell warning signal
- Low profile permits mounting on 0.5-inch printed circuit board centers
- Mates directly with DS1212 Nonvolatile Controller to back up 16 SRAMs
- Uninterruptible supply for CMOS and portable devices

PIN ASSIGNMENT

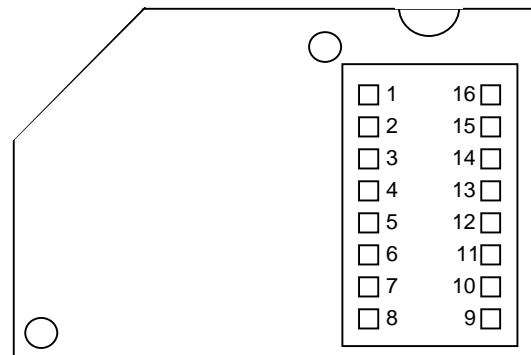

See Mech. Drawings Section

PIN DESCRIPTION

Pins 1, 2, 4, 7, 9, 10 and 14 are No-Connects

Pin 3 is Battery Fail (\overline{BF})

Pin 5 is Battery Out (BAT)

Pin 6 is RESET (RST) Input

Pin 8 is Ground

Pin 11 is Power Fail (\overline{PF})

Pins 12 and 13 are RAM Supply (V_{CCO})

Pins 15 and 16 are +5V Supply (V_{CCI})

DESCRIPTION

The DS1260 SmartBattery is a low-cost, backup energy supply for portable and nonvolatile electronic equipment. A lithium energy source of up to 1 amp hour can supply power to CMOS electronic circuits when primary power is lost through an intelligent and efficient switch. When power is supplied from the lithium power source, the power fail signal is held low to warn electronic (RESET) circuits of the power status. Energy loss during shipping and handling is avoided by pulsing RESET, thereby causing the backup energy source to be isolated from the exposed pins. The DS1260 can be plugged into a standard 16-pin, low-cost DIP socket, allowing for proven interconnect and simple replacement if the energy has been exhausted.

OPERATION

During normal operation V_{CCI} (pins 15 and 16) is the primary energy source and power is supplied to V_{CCO} (pins 12 and 13) through an internal switch at a voltage level of $V_{CCI}-0.2$ volts @ 250 mA. During this time the power-fail signal (\overline{PF}) is held high, indicating valid primary voltage (see Figure 1). However, if the V_{CCI} falls below the level of 4.25 volts, the power-fail signal is driven low. As V_{CCI} falls below the level of the lithium supply ($V_{BAT} = 3$ volts), power is switched and the lithium energy source supplies power to the uninterruptible output (V_{CCO}) at $V_{BAT}-0.2$ volts @ 5 mA.

On power-up, as the V_{CCI} supply rises above 3 volts, the primary energy source, V_{CCI} , becomes the supply. As the V_{CCI} input rises above 4.25 volts, the power-fail signal is driven back to the high level. During normal operation, BAT (Pin 5) stays at the battery level of 3 volts, regardless of the level of V_{CCI} .

BATTERY FAIL

When power is being supplied from the primary energy source, \overline{BF} (Pin 3) is held at a high level (V_{OH}), provided that the lithium energy source is greater than 2 volts. If the lithium energy source should decrease to below 2 volts, the \overline{BF} signal is driven low (V_{OL}), indicating an exhausted lithium battery. The \overline{BF} signal is always low when power is being supplied by the lithium energy source.

RESET

The reset input can be used to prevent the lithium energy source from supplying power to V_{CCO} and BAT even if V_{CCI} falls below 3 volts. This feature is activated by applying a pulsed input on RST to a high level (V_{IH}) for 50ns minimum while primary power is valid (see Figure 2). When primary power is removed after pulsing RST, the V_{CCO} output and BAT will go to high impedance. The next time primary power is applied such that V_{CCI} is greater than V_{BAT} , normal operation resumes and V_{CCO} will be supplied by the lithium energy source when V_{CCI} again falls below 3 volts. BAT will also return to the level V_{BAT} . Figure 3 shows how the SmartBattery is used in a system application.

BLOCK DIAGRAM Figure 1

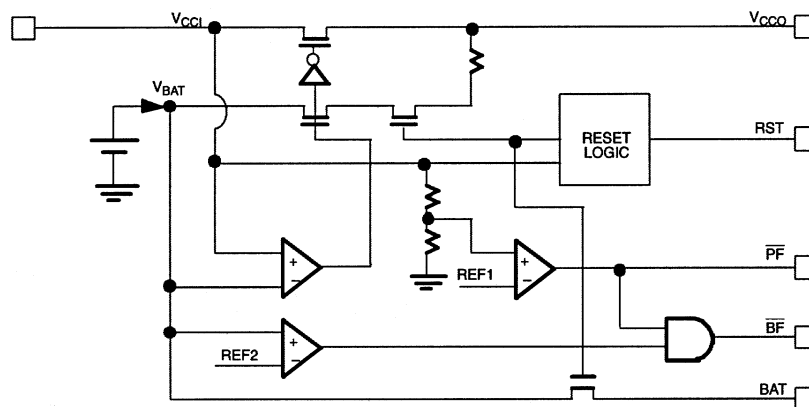

BATTERY PERFORMANCE DS1260-25

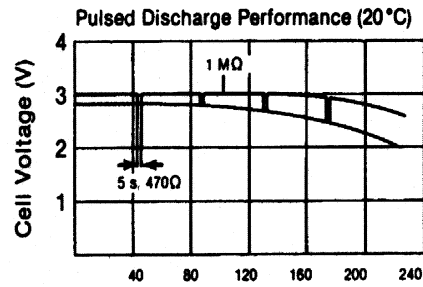
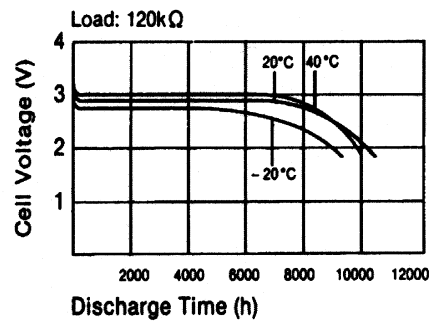
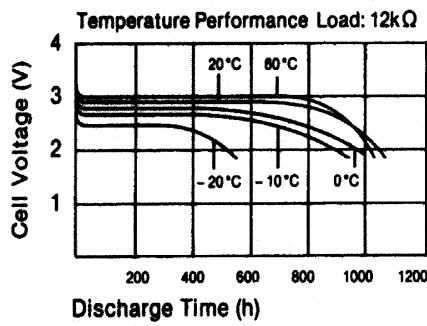
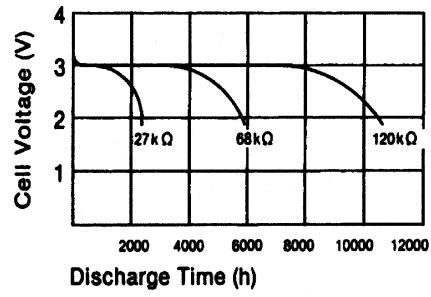
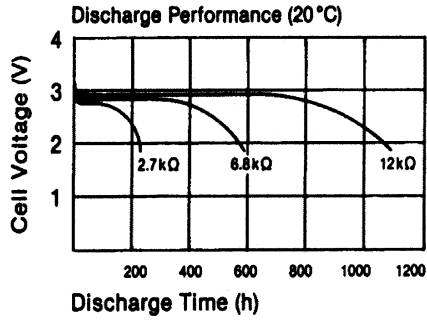

BATTERY PERFORMANCE DS1260-50

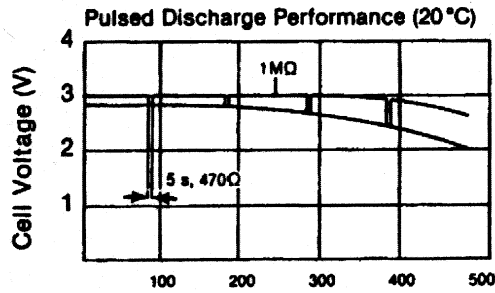
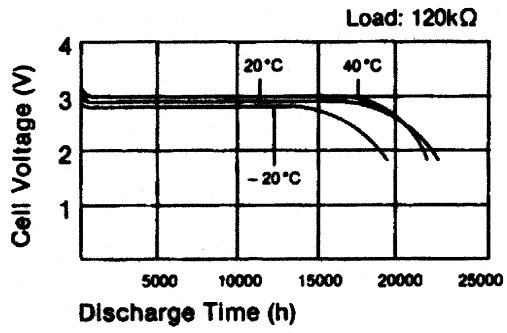
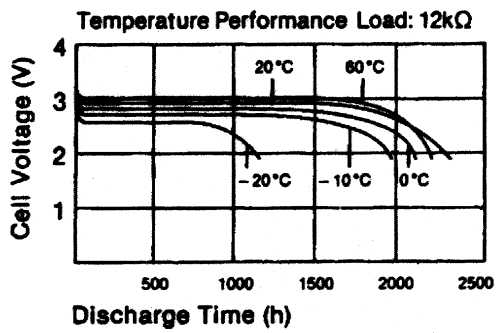
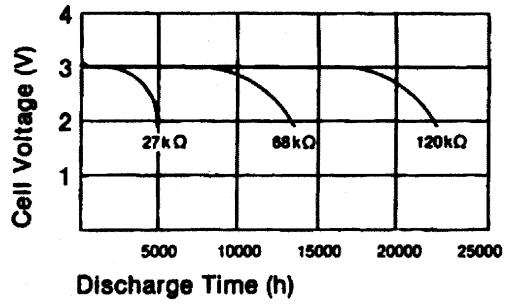
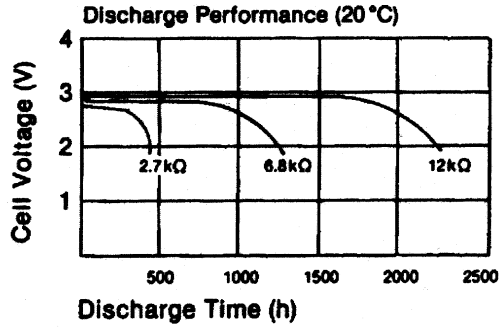

BATTERY PERFORMANCE DS1260-100

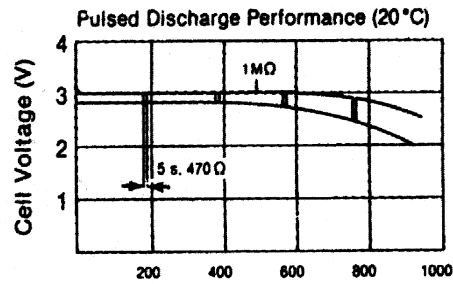
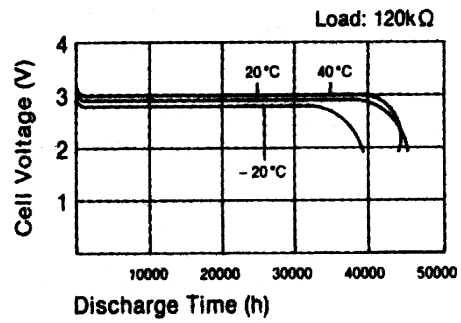
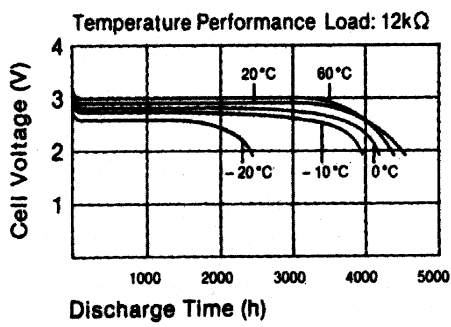
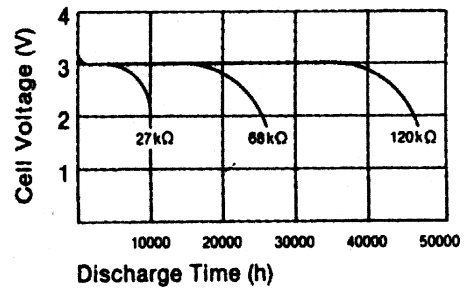
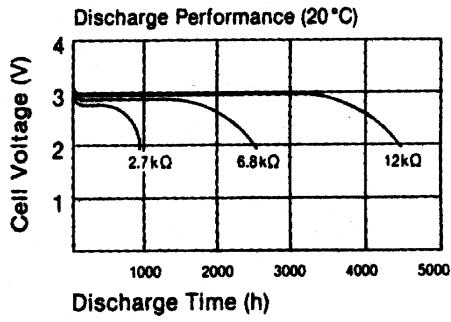
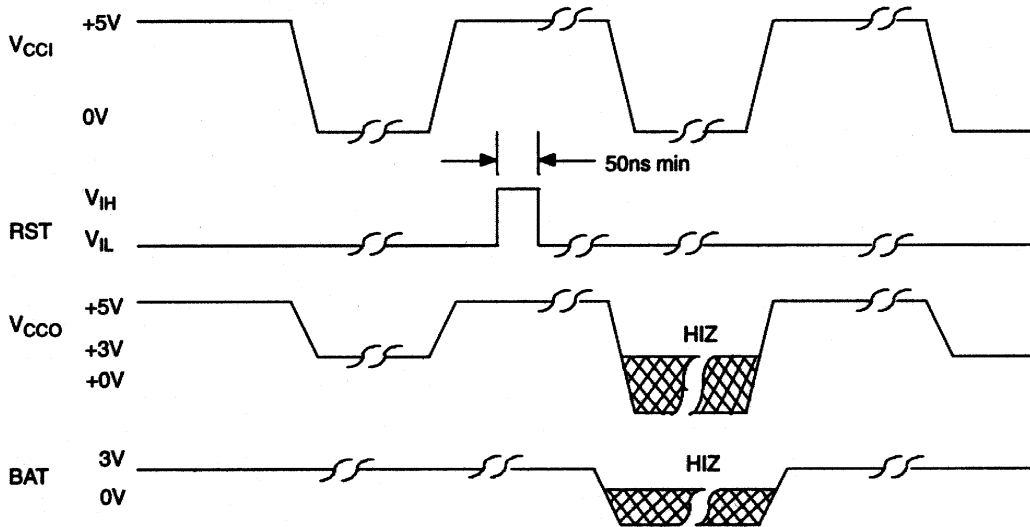

Table 1

PART NO.	CAPACITY	NOMINAL VOLTAGE
DS1260-25	250 mAh	3 volts
DS1260-50	480 mAh	3 volts
DS1260-100	960 mAh	3 volts

RESET TIMING Figure 2



INTEGRATED BATTERY BACKUP – APPLICATIONS Figure 3

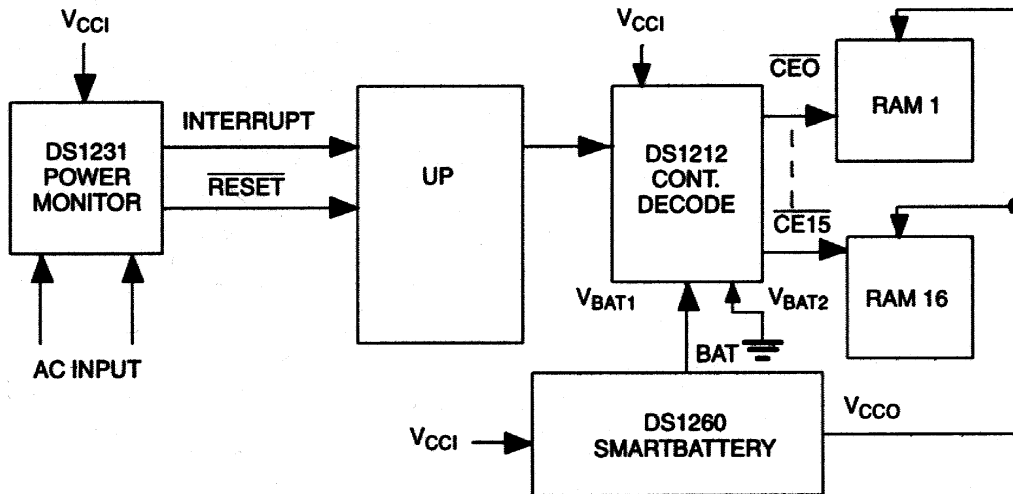

ABSOLUTE MAXIMUM RATINGS*

Voltage on Any Pin Relative to Ground	-0.3V to +7.0V
Operating Temperature	0°C to 70°C
Storage Temperature	-40°C to +70°C
Soldering Temperature	260°C for 10 seconds

* This is a stress rating only and functional operation of the device at these or any other conditions above those indicated in the operation sections of this specification is not implied. Exposure to absolute maximum rating conditions for extended periods of time may affect reliability.

RECOMMENDED DC OPERATING CONDITIONS (0°C to 70°C)

PARAMETER	SYMBOL	MIN	TYP	MAX	UNITS	NOTES
Primary Power Supply	V _{CC}	4.5	5.0	5.5	V	1
Input High Voltage	V _{IH}	2.0		V _{CCI} +0.3	V	1
Input Low Voltage	V _{IL}	-0.3		+0.8	V	1

DC ELECTRICAL CHARACTERISTICS (0°C to 70°C; V_{CCI} = 4.0 to 5.5V)

PARAMETER	SYMBOL	MIN	TYP	MAX	UNITS	NOTES
Leakage Current	I _{LO}	-1.0		+1.0	μA	
Output Current @ 2.4V	I _{OH}	-1.0			mA	1, 2
Output Current @ 0.4V	I _{OL}			+4.0	mA	1, 2
Input Supply Current	I _{CCI}			5	mA	3
Pins 12, 13 V _{CCO} =V _{CCI} -0.2	I _{CCO}			250	mA	
Pin 11 $\overline{\text{PF}}$ Detect	V _{TP}		4.25	4.5	V	4
Pin 3 $\overline{\text{BF}}$ Detect	V _{BATF}		2.0		V	7

(0°C to 70°C; V_{CCI} < V_{BAT})

Pin 5 Battery Voltage	V _{BAT}		3		V	6
Pins 12, 13 V _{CCO} =V _{BAT} -0.2	I _{CCO2}			15	mA	5
Battery Leakage	I _{BAT}			100	nA	8, 9
Pin 5 Battery Output Current	I _{BATOUT}			100	μA	

CAPACITANCE (t_A = 25°C)

PARAMETER	SYMBOL	MIN	TYP	MAX	UNITS	NOTES
Output Capacitance	C _O		5	10	pF	
Input Capacitance	C _I		5	10	pF	

AC ELECTRICAL CHARACTERISTICS (0°C to 70°C; V_{CCI} = 4.0 to 5.5V)

PARAMETER	SYMBOL	MIN	TYP	MAX	UNITS	NOTES
V _{CCI} Slew Rate	t _F	300			μs	
V _{CCI} Slew Rate	t _R	1			μs	
Power-Down to $\overline{\text{PF}}$ Low	t _{PF}	0			μs	
$\overline{\text{PF}}$ High after Power-Up	t _{REC}			100	μs	

POWER-DOWN/POWER-UP CONDITION

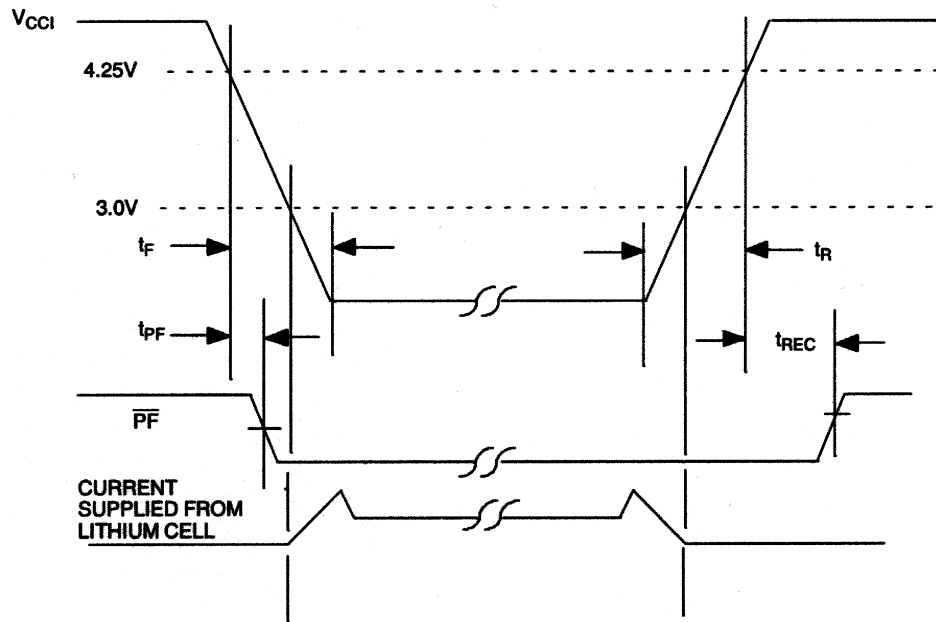

WARNING:

Under no circumstances are negative undershoots, of any amplitude, allowed when device is in battery backup mode.

Water washing for flux removal may discharge internal lithium source as exposed voltage pins are present.

NOTES:

1. Voltages are referenced to ground.
2. Load capacity is 50 pF.
3. Measured with Pins 11, 12, 13, and 3 open.
4. V_{TP} is the point that \overline{PF} is driven low.
5. Sustained I_{CCO2} currents above 1 mA cause a significant drop in battery voltage.
6. V_{BAT} is the internal lithium energy source voltage.
7. V_{BATF} is the point that \overline{BF} is driven low.
8. Battery leakage is the internal energy consumed by the DS1260.
9. Storage loss is less than 1% per year at 25°C.
10. $V_{CCI} = +5$ volts; $t_A = 25^\circ\text{C}$.