

# MDB1900ZC



## Zero Delay Buffer for PCIe (Gen1/Gen2/Gen3), SAS, SATA, ESI, and QPI

### General Description

The MDB1900ZC is a true zero delay buffer with a fully integrated, high-performance, low-power, and low-phase noise programmable PLL.

The MDB1900ZC is capable of distributing the reference clocks for PCIe (Gen1/Gen2/Gen3), SATA, ESI, SAS, SMI, and [Intel® Quickpath Interconnect \(QPI\)](#). The MDB1900ZC works in conjunction with a CK410B+, CK509B, or CK420BQ clock synthesizer to provide reference clocks to multiple agents.

The MDB1900ZC is designed for Intel's DB1900Z specification with the exception that the zero delay buffer feedback path is inside the IC and does not need to be built onto the PCB.

Datasheets and support documentation are available on Micrel's website at: [www.micrel.com](http://www.micrel.com).

### Block Diagram

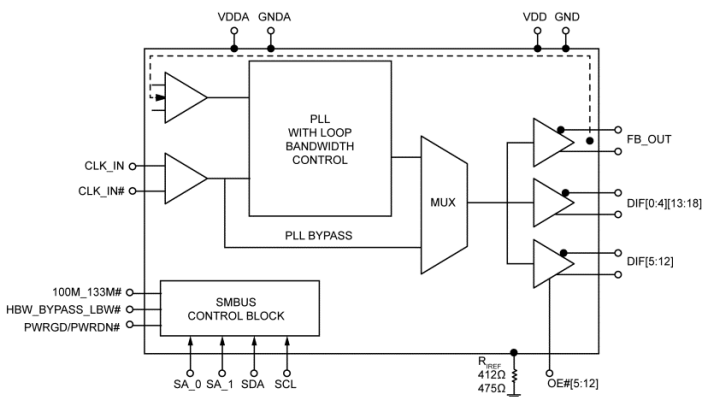

### Features

- Supports zero delay (0ps) buffer mode for 100MHz and 133MHz clock frequencies.
- Internal feedback path for zero delay (PLL) mode
- Zero delay (PLL) mode can filter jitter in incoming clock
- Selectable PLL bandwidth for PLL mode
- Supports fanout buffer mode for clock frequencies between 0MHz and 250MHz
- Differential input reference with HCSL logic (0V~0.7V)
- Nineteen differential HCSL-compatible clock output pairs
- Eight dedicated OE# pins to control their assigned output. Glitch free assertion/de-assertion.
- Spread spectrum modulation tolerant for EMI reduction
- SMBus interface for controlling output properties (enable/disable and delay tuning)
- Disabled outputs in power-down mode for maximum power savings
- Nine selectable SMBus addresses so multiple devices can share the same SMBus
- 3.3V or 2.5V operation
- Commercial or industrial temperature ranges
- 72-pin 10mm x 10mm QFN package
- GREEN, RoHS, and PFOS compliant

### Applications

- PCI Express timing (Gen1/2/3) in Intel platforms, specifically the Romley platform
- SATA/SAS timing (storage)
- ESI and SMI systems (storage)
- Intel Quickpath Interconnect

### Key Specifications

- Cycle-to-cycle jitter (PLL mode): <35ps
- Output-to-output skew: <35ps
- Input-to-output delay (PLL mode): Fixed at 0ps
- Input-to-output delay variation (PLL mode): 13ps
- Phase jitter, PCIe Gen3: 0.25ps
- Accumulated jitter, QPI 9.6Gbps: <0.15ps

Intel is a registered trademark of Intel Corporation.

Micrel Inc. • 2180 Fortune Drive • San Jose, CA 95131 • USA • tel +1 (408) 944-0800 • fax + 1 (408) 474-1000 • <http://www.micrel.com>

## Ordering Information

Part Number	Marking	Shipping	Ambient Temperature Range	Package <sup>(1)</sup>
MDB1900ZCQY TR	MDB1900ZCQ	Tape and Reel	-40°C to +85°C	72-Pin 10mm x 10mm QFN
MDB1900ZCQZ TR	MDB1900ZCQ	Tape and Reel	0°C to +70°C	72-Pin 10mm x 10mm QFN

**Note:**

1. Device is GREEN, RoHS, and PFOS compliant. Lead finish is 100% matte tin.

## Pin Configuration

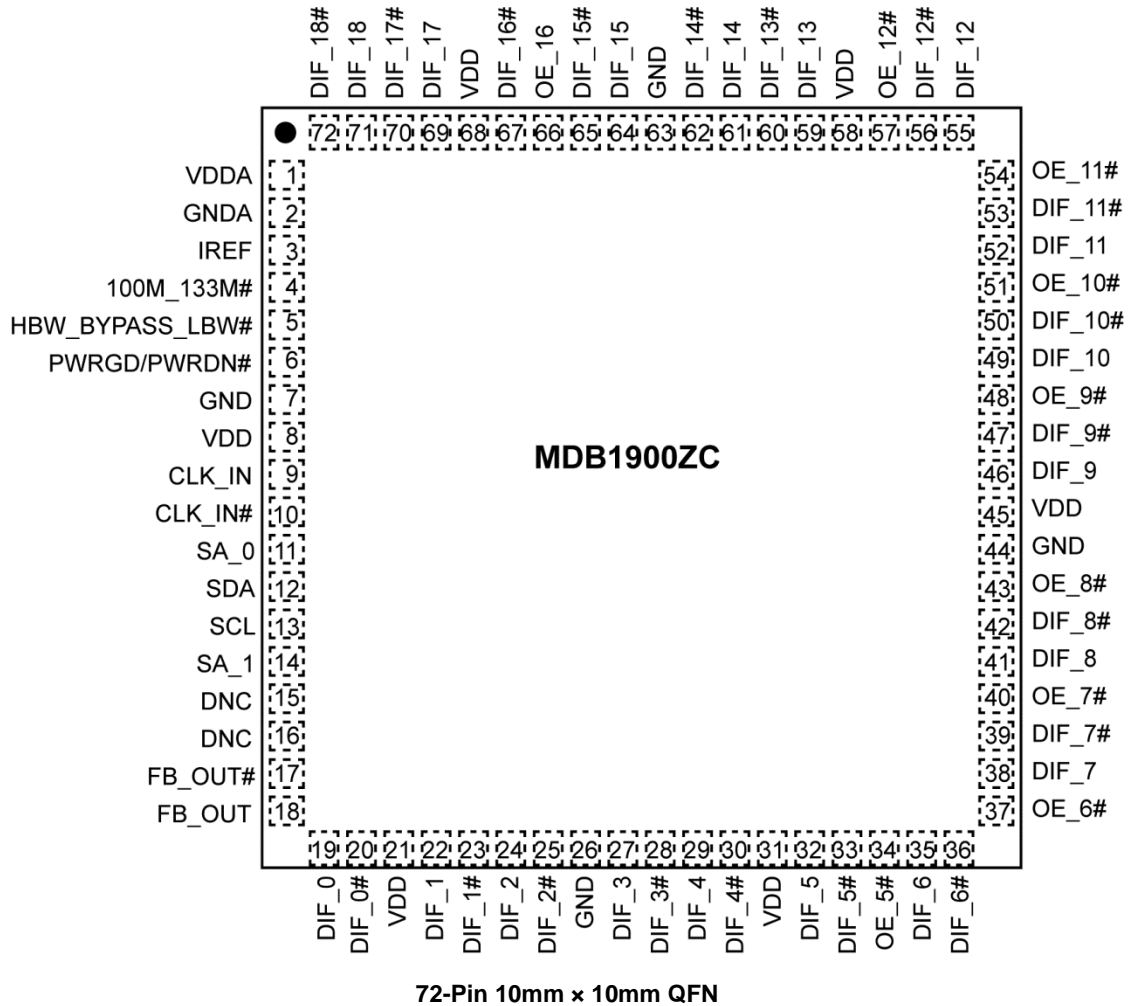

## Pin Description

Pin Number	Pin Name	Type <sup>(2)</sup>	Pin Function
1	VDDA	PWR	3.3V or 2.5V Core Power Supply.
2	GND	GND	Core Ground.
3	IREF	I	$I_{REF} = (1.1V)/(R_{IREF})$ . A precision resistor ( $R_{IREF}$ ) is attached to this pin and to ground to set the reference current for the differential current mode output pairs. $R_{IREF} = 475\Omega$ for 100 $\Omega$ trace, $R_{IREF} = 412\Omega$ for 85 $\Omega$ trace.
4	100M_133M#	I, SE	3.3V LVTTTL Input. Input/output frequency select. Logic 1 = 100MHz output (default, 50K $\Omega$ pull-up resistor) Logic 0 = 133.33MHz output
5	HBW_BYPASS_LBW#	I, SE	Tri-level input for selecting bypass or PLL bandwidth mode. High = High PLL bandwidth mode Mid = Bypass mode Low = Low PLL bandwidth mode
6	PWRGD/PWRDN#	I, SE	3.3V LVTTTL Input for power good and power-down control. 50K $\Omega$ pull-down resistor.
7	GND	GND	Ground.
8	VDDR	PWR	3.3V or 2.5V power supply for differential clock input.
9	CLK_IN	I, DIF	0.7V HCSL differential clock input reference. True input pin.
10	CLK_IN#	I, DIF	0.7V HCSL differential clock input reference. Complementary input pin.
11	SA_0	I, SE	Tri-level input to set SMBus address for this device. Works together with SA_1.
12	SDA	I/O	Open Collector SMBus Data I/O Pin (SDATA). 5V tolerant.
13	SCL	I, SE	SMBus Slave Clock Input (SCLK). 5V tolerant.
14	SA_1	I, SE	Tri-level input to set SMBus address for this device. Works together with SA_0.
15	DNC	NC	Do not connect.
16	DNC	NC	Do not connect.
17	FB_OUT	O, DIF	ZDB Feedback, 0.7V differential clock output (HCSL-compatible), true output pin.
18	FB_OUT#	O, DIF	ZDB Feedback, 0.7V differential clock output (HCSL-compatible), complementary output pin.
19	DIF_0	O, DIF	0.7V Differential Clock Output 0 (HCSL-compatible), true output pin.
20	DIF_0#	O, DIF	0.7V Differential Clock Output 0 (HCSL-compatible), complementary output pin.
21	VDD	PWR	3.3V or 2.5V Power Supply.
22	DIF_1	O, DIF	0.7V Differential Clock Output 1 (HCSL-compatible), true output pin.
23	DIF_1#	O, DIF	0.7V Differential Clock Output 1 (HCSL-compatible), complementary output pin.
24	DIF_2	O, DIF	0.7V Differential Clock Output 2 (HCSL-compatible), true output pin.

### Note:

- I = Input
  - O = Output
  - I/O = Bi-directional
  - SE = Single-ended
  - DIF = Differential
  - PWR = 3.3V or 2.5V power
  - GND = Ground

**Pin Description (Continued)**

Pin Number	Pin Name	Type <sup>(2)</sup>	Pin Function
25	DIF_2#	O, DIF	0.7V Differential Clock Output 2 (HCSL-compatible), complementary output pin.
26	GND	GND	Ground.
27	DIF_3	O, DIF	0.7V Differential Clock Output 3 (HCSL-compatible), true output pin.
28	DIF_3#	O, DIF	0.7V Differential Clock Output 3 (HCSL-compatible), complementary output pin.
29	DIF_4	O, DIF	0.7V Differential Clock Output 4 (HCSL-compatible), true output pin.
30	DIF_4#	O, DIF	0.7V Differential Clock Output 4 (HCSL-compatible), complementary output pin.
31	VDD	PWR	3.3V or 2.5V power supply.
32	DIF_5	O, DIF	0.7V Differential Clock Output 5 (HCSL-compatible), true output pin.
33	DIF_5#	O, DIF	0.7V Differential Clock Output 5 (HCSL-compatible), complementary output pin.
34	OE_5#	I, SE	3.3V LVTTTL active-low input for enabling Differential Output 5 (50k $\Omega$ pull-down).
35	DIF_6	O, DIF	0.7V Differential Clock Output 6 (HCSL-compatible), true output pin.
36	DIF_6#	O, DIF	0.7V Differential Clock Output 6 (HCSL-compatible), complementary output pin.
37	OE_6#	I, SE	3.3V LVTTTL active-low input for enabling Differential Output 6 (50k $\Omega$ pull-down).
38	DIF_7	O, DIF	0.7V Differential Clock Output 7 (HCSL-compatible), true output pin.
39	DIF_7#	O, DIF	0.7V Differential Clock Output 7 (HCSL-compatible), complementary output pin.
40	OE_7#	I, SE	3.3V LVTTTL active-low input for enabling Differential Output 7 (50k $\Omega$ pull-down).
41	DIF_8	O, DIF	0.7V Differential Clock Output 8 (HCSL-compatible), true output pin.
42	DIF_8#	O, DIF	0.7V Differential Clock Output 8 (HCSL-compatible), complementary output pin.
43	OE_8#	I, SE	3.3V LVTTTL active-low input for enabling Differential Output 8 (50k $\Omega$ pull-down).
44	GND	GND	Ground
45	VDD	PWR	3.3V or 2.5V power supply.
46	DIF_9	O, DIF	0.7V Differential Clock Output 9 (HCSL-compatible), true output pin.
47	DIF_9#	O, DIF	0.7V Differential Clock Output 9 (HCSL-compatible), complementary output pin.
48	OE_9#	I, SE	3.3V LVTTTL active-low input for enabling Differential Output 9 (50k $\Omega$ pull-down).
49	DIF_10	O, DIF	0.7V Differential Clock Output 10 (HCSL-compatible), true output pin.
50	DIF_10#	O, DIF	0.7V Differential Clock Output 10 (HCSL-compatible), complementary output pin.

**Pin Description (Continued)**

Pin Number	Pin Name	Type <sup>(2)</sup>	Pin Function
51	OE_10#	I, SE	3.3V LVTTTL active-low input for enabling Differential Output 10 (50kΩ pull-down).
52	DIF_11	O, DIF	0.7V Differential Clock Output 11 (HCSL-compatible), true output pin.
53	DIF_11#	O, DIF	0.7V Differential Clock Output 11 (HCSL-compatible), complementary output pin.
54	OE_11#	I, SE	3.3V LVTTTL active-low input for enabling Differential Output 11 (50kΩ pull-down).
55	DIF_12	O, DIF	0.7V Differential Clock Output 12 (HCSL-compatible), true output pin.
56	DIF_12#	O, DIF	0.7V Differential Clock Output 12 (HCSL-compatible), complementary output pin.
57	OE_12#	I, SE	3.3V LVTTTL active-low input for enabling Differential Output 12 (50kΩ pull-down).
58	VDD	PWR	3.3V or 2.5V Power Supply.
59	DIF_13	O, DIF	0.7V Differential Clock Output 13 (HCSL-compatible), true output pin.
60	DIF_13#	O, DIF	0.7V Differential Clock Output 13 (HCSL-compatible), complementary output pin.
61	DIF_14	O, DIF	0.7V Differential Clock Output 14 (HCSL-compatible), true output pin.
62	DIF_14#	O, DIF	0.7V Differential Clock Output 14 (HCSL-compatible), complementary output pin.
63	GND	GND	Ground.
64	DIF_15	O, DIF	0.7V Differential Clock Output 15 (HCSL-compatible), true output pin.
65	DIF_15#	O, DIF	0.7V Differential Clock Output 15 (HCSL-compatible), complementary output pin.
66	DIF_16	O, DIF	0.7V Differential Clock Output 16 (HCSL-compatible), true output pin.
67	DIF_16#	O, DIF	0.7V Differential Clock Output 16 (HCSL-compatible), complementary output pin.
68	VDD	PWR	3.3V or 2.5V Power Supply.
69	DIF_17	O, DIF	0.7V Differential Clock Output 17 (HCSL-compatible), true output pin.
70	DIF_17#	O, DIF	0.7V Differential Clock Output 17 (HCSL-compatible), complementary output pin.
71	DIF_18	O, DIF	0.7V Differential Clock Output 18 (HCSL-compatible), true output pin.
72	DIF_18#	O, DIF	0.7V Differential Clock Output 18 (HCSL-compatible), complementary output pin.
ePad	Exposed Pad	GND	The center pad must be connected to the ground plane both for electrical ground and thermal relief.

**Absolute Maximum Ratings<sup>(3)</sup>**

Analog Supply Voltage ( $V_{DDA}$ )	+4.6V
I/O Supply Voltage ( $V_{DD}$ )	+4.6V
Input Low Voltage ( $V_{IL}$ )	-0.5V
Input High Voltage ( $V_{IH}$ )	+4.6V
Storage Temperature ( $T_S$ )	-65°C to +150°C
ESD Rating <sup>(5)</sup>	2kV

**Operating Ratings<sup>(4)</sup>**

Supply Voltage ( $V_{DD}, V_{DDA}$ )	+2.375V to +3.465V
Ambient Temperature ( $T_A$ )	0°C to +70°C
Junction Temperature ( $T_J$ )	+125°C
Case Temperature ( $T_C$ )	+110°C
Thermal Resistance, Junction-to-Ambient ( $T_{JA}$ )	
Still Air	26°C/W

**DC Electrical Characteristics<sup>(6)</sup>**

$V_{DDA} = V_{DD} = 3.3V$  or  $2.5 \pm 5\%$ ,  $T_A = 0^\circ C$  to  $+70^\circ C$ .

Symbol	Parameter	Condition	Min.	Typ.	Max.	Units
$V_{DDA}, V_{DD}$	3.3V or 2.5V Operating Range	3.3V or 2.5V $\pm 5\%$	2.375		3.465	V
$V_{IH}$	Input High Voltage	$V_{DD} = 3.3V$ . Single-ended inputs, except SMBus and tri-level inputs.	2		$V_{DD} + 0.3$	V
$V_{IL}$	Input Low Voltage	$V_{DD} = 3.3V$ . Single-ended inputs, except SMBus and tri-level inputs.	GND - 0.3		0.8	V
$I_{IL}$	Input Leakage Current <sup>(7)</sup>	$0 < V_{IN} < V_{DD}$	-5		5	$\mu A$
$V_{IL\_TRI}$	Input Low Voltage (Tri-Level Input)	$V_{DD} = 3.3V$	0		0.9	V
$V_{IM\_TRI}$	Input Mid Voltage (Tri-Level Input)	$V_{DD} = 3.3V$	1.3		1.8	V
$V_{IH\_TRI}$	Input High Voltage (Tri-Level Input)	$V_{DD} = 3.3V$	2.4		$V_{DD}$	V
$C_{IN}$	Input Capacitance <sup>(8)</sup>		1		4.5	pF
$C_{OUT}$	Output Capacitance <sup>(8)</sup>		1		4.5	pF
$L_{PIN}$	Pin Inductance				7	nH
$I_{DD\_3.3V}$	Operating Supply Current ( $I_{DDA} + I_{DD}$ )	All outputs driven.			450	mA
$I_{DD\_3.3PD}$	Power-Down Current	$V_{DD} = 3.3V$ . All differential pairs tri-stated.			43	mA
$V_{DD\_SMB}$	Nominal SMBus Voltage		2.7		5.5	V
$V_{OL\_SMB}$	SMBus Output Low Voltage	@ $I_{PULLUP}$			0.4	V
$V_{IH\_SMB}$	SMBus input High Voltage		2.1		$V_{DD\_SMB}$	V
$V_{IL\_SMB}$	SMBus input Low Voltage				0.8	V

**Notes:**

- Exceeding the absolute maximum ratings may damage the device.
- The device is not guaranteed to function outside its operating ratings.
- Devices are ESD sensitive. Handling precautions are recommended. Human Body Model.
- Specification for packaged product only.
- Input leakage current. Does not include inputs with pull-up or pull-down resistors.
- Capacitance value does not include pin capacitance.

## DC Electrical Characteristics<sup>(6)</sup> (Continued)

$V_{DDA} = V_{DD} = 3.3V$  or  $2.5 \pm 5\%$ ,  $T_A = 0^\circ C$  to  $+70^\circ C$ .

Symbol	Parameter	Condition	Min.	Typ.	Max.	Units
$I_{PULLUP(SMBUS)}$	Current-Through Pull-Up Resistance or Current Source		100		470	$\mu A$
$R_{PULLUP(SMBUS)}$	Pull-Up Resistance Value	$V_{DD} = 3.3V \pm 5\%$	4.7		27	$K\Omega$
$T_{R(SMBUS)}$	Rise Time for SDA and SCL	$(V_{IL(MAX)} - 0.15)$ to $(V_{IH(MIN)} + 0.15)$			1000	ns
$T_{F(SMBUS)}$	Fall Time for SDA and SCL	$(V_{IH(MIN)} + 0.15)$ to $(V_{IL(MAX)} - 0.15)$			300	ns

## AC Electrical Characteristics – (CLK\_IN, CLK\_IN#) Clock Input Parameters

$V_{DDA} = V_{DD} = 3.3V$  or  $2.5V \pm 5\%$ ,  $T_A = 0^\circ C$  to  $+70^\circ C$ .

Symbol	Parameter	Condition	Min.	Typ.	Max.	Units
$V_{IH}$ (CLK_IN), (CLK_IN#)	Differential Input High Voltage	Statistical measurement on single-ended signal using oscilloscope $V_{HIGH}$ math function.	660		850	mV
$V_{IL}$ (CLK_IN), (CLK_IN#)	Differential Input Low Voltage	Statistical measurement on single-ended signal using oscilloscope $V_{LOW}$ math function.	-150			mV
$V_{IHMAX}$ (CLK_IN), (CLK_IN#)	Differential Input Maximum Voltage (include overshoot)	Statistical measurement on single-ended signal using absolute value.			1150	mV
$V_{ILMIN}$ (CLK_IN), (CLK_IN#)	Differential Input Minimum Voltage (include undershoot)	Statistical measurement on single-ended signal using absolute value.	-300			mV
$V_{SWING}$ (CLK_IN), (CLK_IN#)	Differential Input Swing (include over/undershoot)	Differential input (peak-to-peak).	300		1450	mV
$V_{OX}$ (CLK_IN), (CLK_IN#)	Crossing Point Input Voltage (absolute)		250		550	mV
$V_{OXV}$ (CLK_IN), (CLK_IN#)	Crossing Point Input Voltage (variation)	Variation of crossing over all edges.			140	mV
Edge Rate (CLK_IN), (CLK_IN#)	Minimum (CLK_IN)/(CLK_IN#) Edge Rate <sup>(9)</sup>	Based on single-ended measurement.	0.35			V/ns
Slew Rise (CLK_IN), (CLK_IN#)	Input Rising Slew Rate <sup>(10)</sup>	Differential measurement	0.70		4	V/ns

### Notes:

9. The minimum input edge rate is 0.35V/ns single-ended or 0.7V/ns differential for both 100MHz and 133.33MHz.

10. The slew rate (0.70V/ns to 4V/ns) measurement on differential waveform for both 100MHz and 133.33MHz.

**AC Electrical Characteristics – (CLK\_IN, CLK\_IN#) Clock Input Parameters (Continued)**

$V_{DDA} = V_{DD} = 3.3V$  or  $2.5V \pm 5\%$ ,  $T_A = 0^{\circ}C$  to  $+70^{\circ}C$ .

Symbol	Parameter	Condition	Min.	Typ.	Max.	Units
Slew Fall (CLK_IN), (CLK_IN#)	Input Falling Slew Rate <sup>(10)</sup>	Differential measurement.	0.70		4	V/ns
DC (CLK_IN), (CLK_IN#)	Input Duty Cycle	Differential measurement.	45		55	%
CY-CY Jitter (CLK_IN), (CLK_IN#)	Cycle-to-cycle Input Jitter				50	ps

**Spread Spectrum (SSC) Specification for Clock Input (CLK\_IN, CLK\_IN#)**

Symbol	Parameter	Value
Modulation	Down Spread	(-0.5%) Maximum
Modulation Frequency	Modulation Frequency	30kHz to 33kHz
Modulation Profile	Triangular or Lexmark	(-0.5%) Maximum



## AC Electrical Characteristics – HCSL Outputs

$V_{DDA} = V_{DD} = 3.3V$  or  $2.5V \pm 5\%$ ,  $T_A = 0^\circ C$  to  $+70^\circ C$ .

Symbol	Parameter	Condition (100MHz, 133.33MHz)	Min.	Typ.	Max.	Units
$T_{STAB}$	Clock Stabilization Time <sup>(11)</sup>			160	300	$\mu s$
$L_{ACCURACY}$	Long Accuracy <sup>(12, 13, 14, 15, 16)</sup>				100	ppm
$T_{ABSMIN}$	Absolute Minimum Host CLK Period <sup>(12, 16, 17)</sup>	When (-0.5%) spread spectrum clock input (SSC <sub>ON</sub> ).	(Period – 0.125ns)			ns
$T_{ABSMIN}$	Absolute Minimum Host CLK Period <sup>(12, 16, 17)</sup>	When non-spread spectrum SSC clock input (SSC <sub>OFF</sub> ).	-2.5%			ns
Edge Rate	Edge Rate <sup>(18)</sup>	Measurement from differential waveform.	1.0	2.5	4.0	V/ns
$T_R$	Rise Time <sup>(19, 20)</sup> (see Figure 2)	Single-ended measurement $V_{OL} = 0.175V$ , $V_{OH} = 0.525V$ .	175	225	700	ps
$T_F$	Fall Time <sup>(19, 20)</sup> (see Figure 2)	Single-ended measurement $V_{OH} = 0.525V$ , $V_{OL} = 0.175V$ .	175	225	700	ps

### Notes:

- This is the time from ramping the power supply, or assertion the PWRGD and when valid CLK\_IN input until the time that stable clocks are output from the device (PLL locked).
- All long-time accuracy and clock period specifications are guaranteed assuming that the input reference (CLK\_IN, CLK\_IN#) meets the CK410B+ or CK420BQ clock period specifications.
- The long accuracy is 0ppm, when average only over any integer number of SSC periods.
- When (SSC<sub>OFF</sub>), using the frequency counter with the measurement interval equal to or greater than 0.15s, target frequencies are 100,000,000Hz, 133,333,333Hz.
- When (SSC<sub>ON</sub>), using the frequency counter with the measurement interval equal to or greater than 0.15s, target frequencies are 99,750,000Hz, 133,000,000Hz.
- Measurement taken from differential waveform.
- The average period over any 1 $\mu s$  period of time must be greater than the minimum and less than the maximum specified period.
- Measure taken from differential waveform on a component test board. The edge (slew) rate is measured from (-150mV) to (+150mV) on the differential waveform. Scope is set to average. Signal must be monotonic through the  $V_{OL}$  to  $V_{OH}$  region for  $T_R$  and  $T_F$ .
- Measured from  $V_{OL} = 0.175V$  and  $V_{OH} = 0.525V$ . Only valid for rising clock and falling CLK#. Signal must be monotonic through  $V_{OL}$  to  $V_{OH}$  region for  $T_R$  and  $T_F$ . Measurement taken from single-ended waveform. The translation will be (0.5V/ns minimum to 2V/ns maximum) for single-ended edge rate. Refer to Figure 2.
- Measurement taken from single-ended waveform.

## AC Electrical Characteristics – HCSL Outputs (Continued)

$V_{DDA} = V_{DD} = 3.3V$  or  $2.5V \pm 5\%$ ,  $T_A = 0^\circ C$  to  $+70^\circ C$ .

Symbol	Parameter	Condition (100MHz, 133.33MHz)	Min.	Typ.	Max.	Units
$\Delta T_R$	Rise Time Variation <sup>(20, 21)</sup>				125	ps
$\Delta T_F$	Fall Time Variation <sup>(20, 21)</sup>				125	ps
$T_{RFM}$	Rise and Fall Time Matching <sup>(20, 21, 22)</sup>	Determined as fraction of $2 \times (T_R - T_F)/(T_R + T_F)$ .			20	%
$V_{HIGH}$	Differential Output High Voltage (typically 0.7V) <sup>(20, 23)</sup>	Statistical measurement on single-ended signal using oscilloscope math function.	660	700	850	mV
$V_{LOW}$	Differential Output Low Voltage (typically 0.0V) <sup>(20, 24)</sup>	Statistical measurement on single-ended signal using oscilloscope math function.	-150	8	50	mV
$V_{OVS}$	Differential Output Maximum Voltage (include overshoot) (see Figure 3)	Statistical measurement on single-ended signal using absolute value.			$V_{HIGH} + 0.3V$	V
$V_{UDS}$	Differential Output Minimum Voltage (include undershoot) (see Figure 3)	Statistical measurement on single-ended signal using absolute value.			$V_{LOW} - 0.3V$	V
$V_{RB}$	Ringback Voltage (see Figure 3)	Statistical measurement on single-ended signal using absolute value (-0.5%) SSC input (SSC <sub>ON</sub> ).	0.2			V
$V_{RB}$	Ringback Voltage (see Figure 3)	Statistical measurement on single-ended signal using absolute value non-SSC input (SSC <sub>OFF</sub> ).	$V_X \pm 0.2$			V
$V_{OX}$ (Absolute)	Absolute Crossing Point Voltages <sup>(20, 25)</sup>	Statistical measurement on single-ended signal using absolute value.	250		550	mV
Total $\Delta V_{OX}$	Total Variation of $V_{OX}$ Over All Edges <sup>(20, 26)</sup>	Statistical measurement on single-ended signal using absolute value.			140	mV

### Notes:

21. Measured with oscilloscope, averaging off, and using minimum/maximum statistics. Variation is the delta between minimum and maximum.
22. Measured with oscilloscope, averaging on, the difference between the rising edge rate (average) of clock versus the falling edge rate (average) of clock#.
23. A statistical average high value for  $V_{HIGH}$  obtained by using the oscilloscope  $V_{HIGH}$  math function.
24. A statistical average low value for  $V_{LOW}$  obtained by using the  $V_{LOW}$  math function.
25. The crossing point should meet the absolute and relative crossing point specifications simultaneously.
26.  $\Delta V_{OX}$  is defined as the total variation of all crossing voltages of rising CLOCK and falling CLOCK#.

## AC Electrical Characteristics – HCSL Outputs (Continued)

$V_{DDA} = V_{DD} = 3.3V$  or  $2.5V \pm 5\%$ ,  $T_A = 0^\circ C$  to  $+70^\circ C$ .

Symbol	Parameter	Condition (100MHz, 133.33MHz)	Min.	Typ.	Max.	Units
Duty Cycle	Differential Output Duty Cycle <sup>(16)</sup> (see Figure 4)	Measurement from differential waveform (measured at $V_{OX}$ ). PLL Mode	45	50	55	%
Duty Cycle Distortion	Differential Output Duty Cycle Distortion <sup>(16, 31)</sup> (see Figure 4)	Measurement from differential waveform (measured at $V_{OX}$ ). Bypass mode at 100MHz	-2	0	+2	%
$T_{SKEW}$	Output-to-Output Delay <sup>(27, 28)</sup> (see Figure 4)	Measured at $V_{OX}$ (common to PLL and bypass mode).		18	35	ps
$T_{PD}$ (CLK_IN) to DIF [18:0]	Input-to-Output Delay <sup>(27, 28)</sup>	Measured at $V_{OX}$ (PLL mode).	-35	$\pm 15$	35	ps
$\Delta T_{PD}$ (CLK_IN) to DIF [18:0]	Input-to-Output Delay Variation <sup>(27)</sup>	Measured at $V_{OX}$ (PLL mode).		13	75	ps
CY-CY Jitter DIF [18:0] DIF# [18:0]	Cycle-to-Cycle Jitter <sup>(16)</sup>	PLL mode.		25	35	ps
$T_{PD}$ (CLK_IN) to DIF [18:0]	Input-to-Output Delay <sup>(27)</sup>	Measured at $V_{OX}$ (bypass mode).	0.7		4.5	ns
$\Delta T_{PD}$ (CLK_IN) to DIF [18:0]	Input-to-Output Delay Variation <sup>(27)</sup>	Measured at $V_{OX}$ (bypass mode) absolute.			225	ps
$T_{DTE}$	Random Differential Tracking Error between two devices in Hi BW mode <sup>(29)</sup>	PLL (HBW) mode, no spread spectrum.			3.5	ps
$T_{DSSTE}$	P2P Differential Spread Spectrum Tracking Error between two devices in Hi BW mode <sup>(30)</sup>	PLL (HBW) mode, SSSCON.			50	ps

### Notes:

27. Measured from differential crossing point ( $V_{OX}$ ) to differential crossing point ( $V_{OX}$ ) with scope averaging on to find mean value.  $V_{OX}$  (relative) minimum and maximum are derived using the following:  $V_{OX}$  (relative) minimum =  $0.250 + 0.5 V_{HAVG} - 0.7V$  and  $V_{OX}$  (relative) maximum =  $0.550 - 0.5 (0.7V - V_{HAVG})$ .
28. Measured into fixed 2pF load capacitor. Input to output skew is measured at the first output edge following the corresponding input.
29. This parameter is measured at the outputs of two MDB1900ZC devices in the HBW mode driven by a CK420BQ. The random differential tracking error is the differential phase jitter. It is the accumulated phase jitter, not including the effect of spread spectrum and not shared by the outputs. The jitter is measured into 2pF load cap and from differential cross-point to differential cross-point
30. This is the P2P difference in spread spectrum tracking error between two MDB1900ZC devices in Hi BW mode. The parameter is measured at the output of two MDB1900ZC devices driven by a CK420BQ with SSSCON.
31. Duty Cycle Distortion is the difference in duty cycle between the output and the input clock when the device is operated in bypass mode.

**Clock Period – SSC Disabled**

SSC <sub>OFF</sub> Center Frequency MHz	Measurement Window							Units
	1 Clock	1µs	0.1s	0.1s	0.1s	1µs	1 Clock	
	–JITTER <sub>C-C</sub> Absolute per Minimum	–SSC Short Average Minimum	–ppm Long Average Minimum	0ppm Period	+ppm Long Average Maximum	+SSC Short Average Maximum	+JITTER <sub>C-C</sub> Absolute per Maximum	
100	9.94900		9.99900	10.00000	10.00100		10.05100	ns
133.0	7.44925		7.49925	7.50000	7.50075		7.55075	ns

**Clock Period – SSC Enabled**

SSC <sub>ON</sub> Center Frequency MHz	Measurement Window							Units
	1 Clock	1µs	0.1s	0.1s	0.1s	1µs	1 Clock	
	–JITTER <sub>C-C</sub> Absolute per Minimum	–SSC Short Average Minimum	–ppm Long Average Minimum	0ppm Period	+ppm Long Average Maximum	+SSC Short Average Maximum	+JITTER <sub>C-C</sub> Absolute per Maximum	
99.75	9.94906	9.99906	10.02406	10.02506	10.02607	10.05107	10.10107	ns
133.0	7.44930	7.44930	7.51805	7.51880	7.51955	7.5830	7.58830	ns

## PLL Bandwidth – Peaking and Phase Jitter (SSC<sub>OFF</sub>)

$V_{DDA} = V_{DD} = 3.3V$  or  $2.5V \pm 5\%$ ,  $T_A = 0^\circ C$  to  $+70^\circ C$ .

Symbol	Condition (100MHz, 133.33MHz)	Min.	Typ.	Max.	Units
PLL Jitter Peaking <sup>(32)</sup>	HBW_BYPASS_LBW# = 0 (low bandwidth)			1.0	dB
	HBW_BYPASS_LBW# = 1 (high bandwidth)			1.0	
PLL Bandwidth <sup>(33)</sup>	HBW_BYPASS_LBW# = 0 (low bandwidth)	0.70	1.0	1.4	MHz
	HBW_BYPASS_LBW# = 1 (high bandwidth)	2	3.0	4	
Phase Jitter (PCIe Gen1) <sup>(34, 36, 37)</sup>	PCIe Gen1 (including PLL BW 1.5MHz – 22MHz, damping factor = 0.54, $T_D = 10ns$ , $F_{TRK} = 1.5MHz$ )		16	50	$\mu S_{(Pk-Pk)}$
Phase Jitter (PCIe Gen2) <sup>(36, 37, 39)</sup>	PCIe Gen2 (including PLL BW 8MHz – 16MHz, jitter peaking = 3dB, damping factor = 0.54, $T_D = 10ns$ ) (low band, $F < 1.5MHz$ )		0.9	1.75	$\mu S_{RMS}$
	PCIe Gen2 (including PLL BW 8MHz – 16MHz, jitter peaking = 3dB, damping factor = 0.54, $T_D = 10ns$ ) (high band, $[1.5MHz < F < Nyquist]$ )		1.1	2.0	
Phase Jitter (PCIe Gen3) <sup>(35, 36, 37, 39)</sup>	PCIe Gen3 (including PLL BW 2MHz – 4MHz, CDR = 10MHz) (low band)		1.9	2.5	$\mu S_{RMS}$
	PCIe Gen3 (including PLL BW 2MHz – 4MHz, CDR = 10MHz) (high band)		0.25	1.0	
Accumulated Jitter (4.8Gbps QPI) <sup>(37, 38, 40)</sup>	QPI, accumulated jitter (4.8Gbps or 6.4Gbps, 100MHz or 133MHz, 12 UI)		0.12	0.25	$\mu S_{RMS}$
Accumulated Jitter (6.4Gbps QPI) <sup>(37, 38, 40)</sup>	QPI, accumulated jitter (4.8Gbps or 6.4Gbps, 100MHz or 133MHz, 12 UI)		0.14	0.25	$\mu S_{RMS}$
Accumulated Jitter (8Gbps QPI_SMI) <sup>(37, 38)</sup>	QPI, accumulated jitter (8Gbps, 100MHz, 12 UI)		0.08	0.20	$\mu S_{RMS}$
Accumulated Jitter (9.6Gbps QPI_SMI) <sup>(37, 38)</sup>	QPI, accumulated jitter (9.6Gbps, 100MHz, 12 UI)		0.06	0.15	$\mu S_{RMS}$
Accumulated Jitter (4MHz SMI)	SMI, 4MHz accumulated jitter		0.06	0.2	$\mu S_{RMS}$
Accumulated Jitter (16MHz SMI)	SMI, 16MHz accumulated jitter		0.12	0.5	$\mu S_{RMS}$

### Notes:

32. Measured as maximum pass band gain. At frequencies with the loop BW, highest point-of-magnification is called PLL jitter peaking.
33. Measured at 3dB down or half-power point.
34. These jitter numbers are defined for a BER of 1E-12. Measured numbers at a smaller sample size have to be extrapolated to this BER target.
35. PCIe Gen3 filter characteristics are subject to final ratification by PCI-SIG. Check with PCI-SIG for latest specification.
36. The damping factor = 0.54 implies a jitter peaking of 3dB.
37. Post processed evaluation through Intel-supplied Matlab scripts.
38. Measuring on 100MHz output using the template file in the clock jitter tool.
39. Measuring on 100MHz PCIe SRC output using the template file in the clock jitter tool.
40. Measuring on 100MHz, 133.33MHz output using the template file in the clock jitter tool.

## PLL Bandwidth – Peaking and Phase Jitter (SSC<sub>ON</sub>)

$V_{DDA} = V_{DD} = 3.3V$  or  $2.5V \pm 5\%$ ,  $T_A = 0^\circ C$  to  $+70^\circ C$ .

Symbol	Condition (100MHz, 133.33MHz)	Min.	Typ.	Max.	Units
PLL Jitter Peaking <sup>(32)</sup>	HBW_BYPASS_LBW# = 0 (low bandwidth)			1.0	dB
	HBW_BYPASS_LBW# = 1 (high bandwidth)			1.0	
PLL Bandwidth <sup>(33)</sup>	HBW_BYPASS_LBW# = 0 (low bandwidth)	0.70	1.0	1.4	MHz
	HBW_BYPASS_LBW# = 1 (high bandwidth)	2	3.0	4	
Phase Jitter (PCIe Gen1) <sup>(34, 36, 37)</sup>	PCIe Gen1 (including PLL BW 1.5MHz – 22MHz, damping factor = 0.54, $T_D = 10ns$ , $F_{TRK} = 1.5MHz$ )		16	50	pS <sub>(Pk-Pk)</sub>
Phase Jitter (PCIe Gen2) <sup>(36, 37, 39)</sup>	PCIe Gen2 (including PLL BW 8MHz – 16MHz, Jitter Peaking = 3dB, damping factor = 0.54, $T_D = 10ns$ ) (low band, $F < 1.5MHz$ )		1.0	1.75	pSRMS
	PCIe Gen2 (including PLL BW 8MHz – 16MHz, Jitter Peaking = 3dB, damping factor = 0.54, $T_D = 10ns$ ) (high band, [ $1.5MHz < F < Nyquist$ ])		1.0	2.0	
Phase Jitter (PCIe Gen3) <sup>(35, 36, 37, 39)</sup>	PCIe Gen3 (including PLL BW 2MHz – 4MHz, CDR = 10MHz) (low band)		2.7	3.0	pSRMS
	PCIe Gen3 (including PLL BW 2MHz – 4MHz, CDR = 10MHz) (high band)		0.28	1.0	
Accumulated Jitter (4.8Gbps QPI) <sup>(37, 38, 40)</sup>	QPI, accumulated jitter (4.8Gbps or 6.4Gbps, 100MHz or 133MHz, 12 UI)		0.18	0.25	pSRMS
Accumulated Jitter (6.4Gbps QPI) <sup>(37, 38, 40)</sup>	QPI, accumulated jitter (4.8Gbps or 6.4Gbps, 100MHz or 133MHz, 12 UI)		0.20	0.25	pSRMS
Accumulated Jitter (8Gbps QPI_SMI) <sup>(37, 38)</sup>	QPI, accumulated jitter (8Gbps, 100MHz, 12 UI)		0.09	0.20	pSRMS
Accumulated Jitter (9.6Gbps QPI_SMI) <sup>(37, 38)</sup>	QPI, accumulated jitter (9.6Gbps, 100MHz, 12 UI)		0.08	0.15	pSRMS
Accumulated Jitter (4MHz SMI)	SMI, 4MHz accumulated jitter		0.12	0.2	pSRMS
Accumulated Jitter (16MHz SMI)	SMI, 16MHz accumulated jitter		0.06	0.5	pSRMS

# Functional Diagram

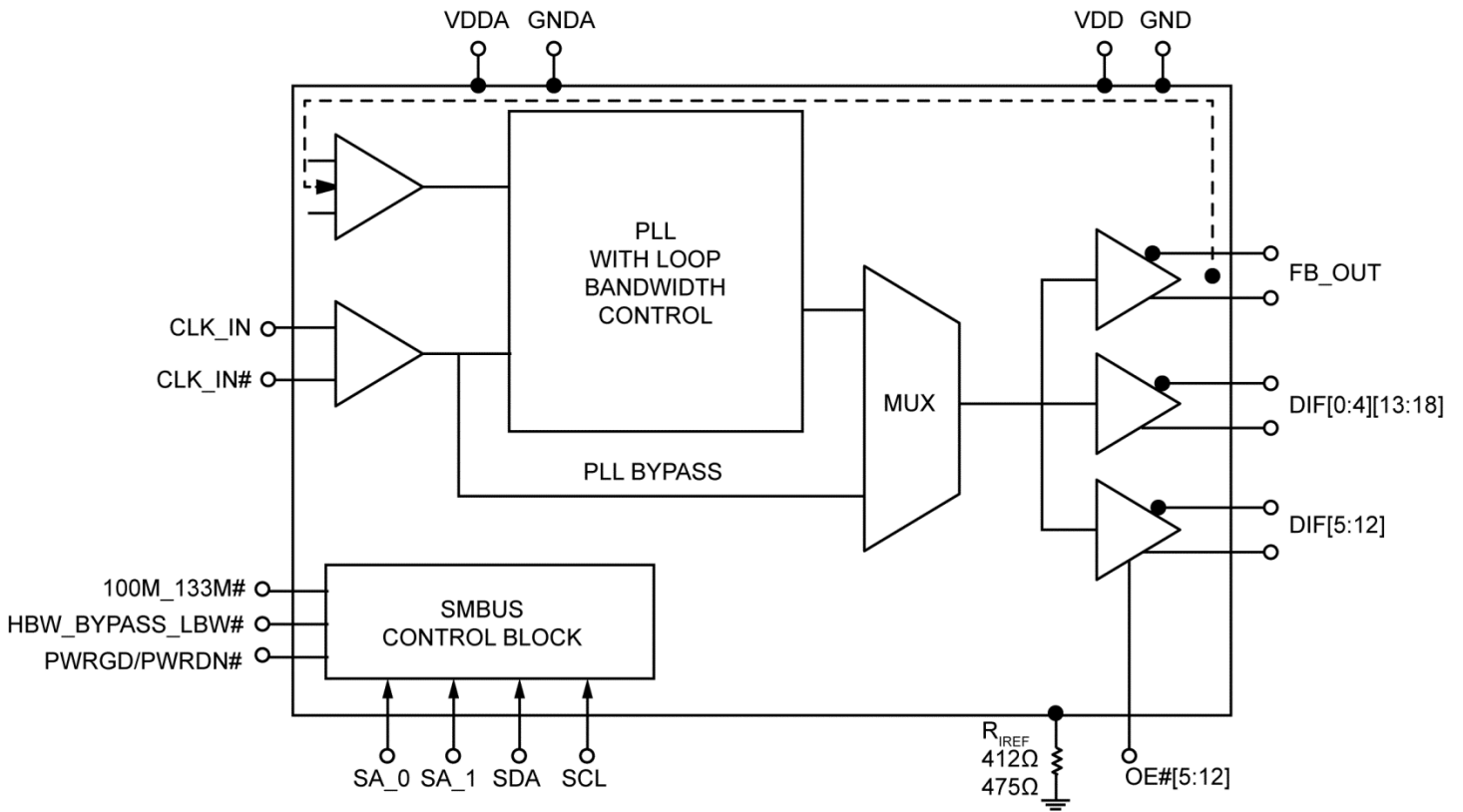

### Feedback (FB\_OUT, FB\_OUT#) Topology

The MDB1900ZC utilizes external feedback topology to achieve low input-to-output delay variation. Place the shunt and series resistors as close to the (FB\_OUT, FB\_OUT#) (Pins 18 and 17) as possible (refer to Figure 1).

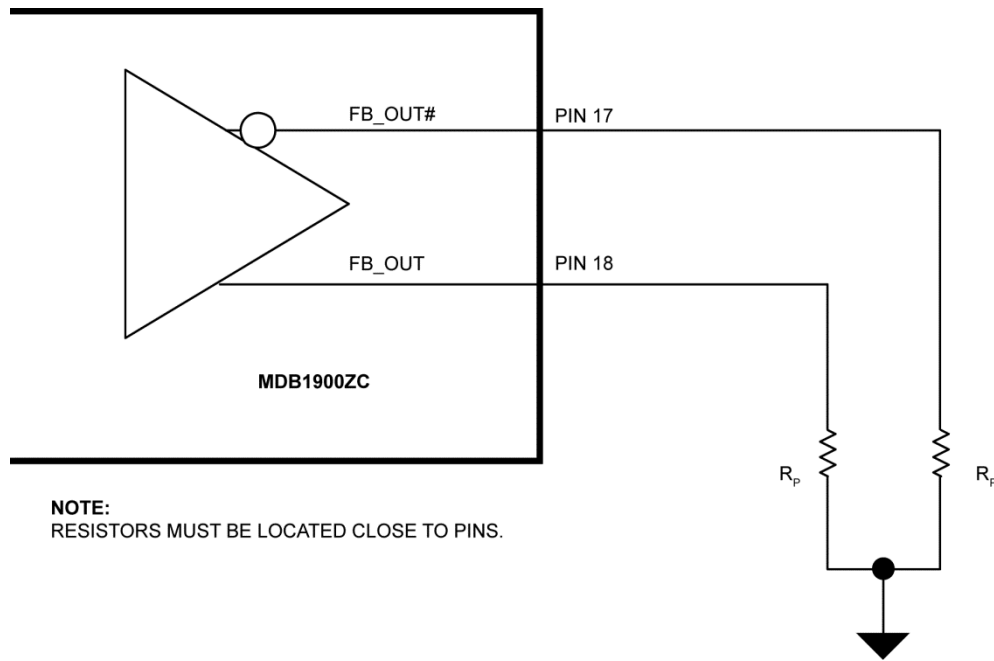

Figure 1. Feedback Termination

Table 1. Feedback Shunt Resistors

Board Table Impedance	$R_p$	Units
100	49.9 (1%)	$\Omega$
85	42.2 (1%)	$\Omega$



## Measurements Points for Differential

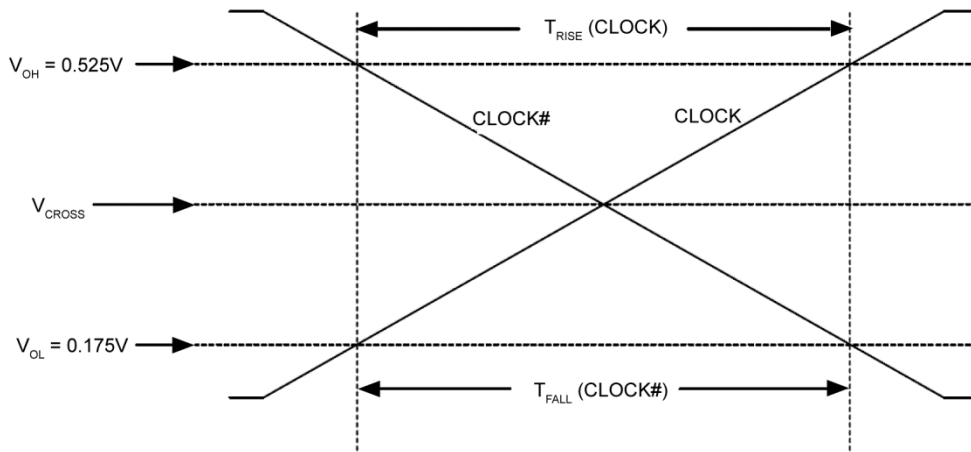

Figure 2. Single-Ended Measurement Points for  $T_{RISE}$  and  $T_{FALL}$

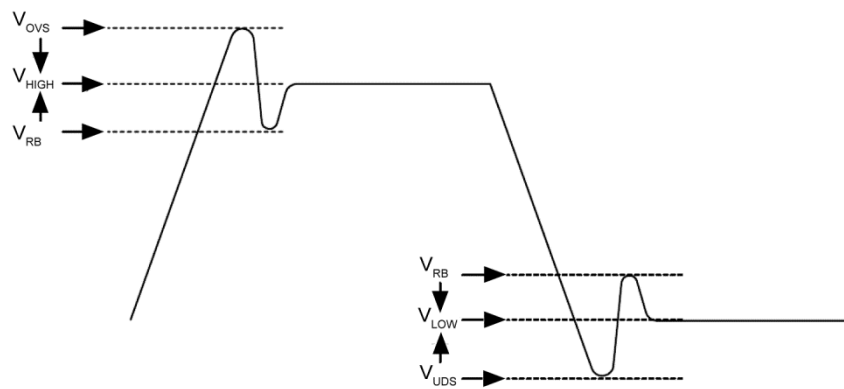

Figure 3. Single-Ended Measurement Points for  $V_{OVS}$ ,  $V_{UBS}$ , and  $V_{RB}$

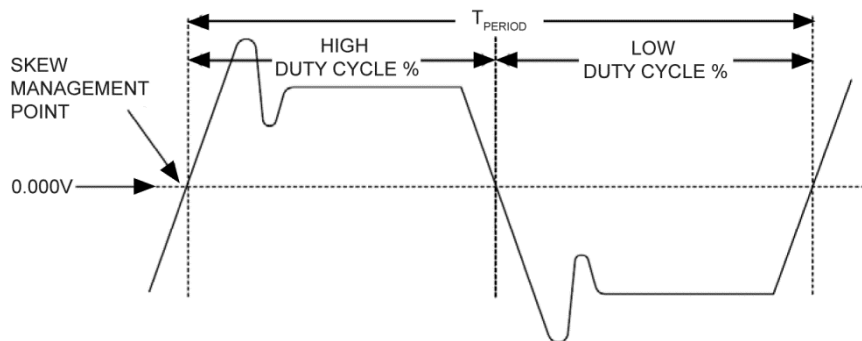

Figure 4. Differential (Clock/Clock#) Measurement Points for  $T_{PERIOD}$ , Duty Cycle, and Jitter

## Termination of HCSL [DIF, DIF# (18:0)] Output Buffers for Testing Conditions

All differential output parameters are measured while driving 10-inch 100Ω or 85Ω differential impedance transmission line segments with 2pF load capacitors at the end of each segment. Measurements are taken across the 2pF load capacitor associated with Clock and Clock# as shown in Figure 5 and Figure 6. For resistive lumped load, board trace impedance and trace length refer to Table 3.

**Table 2. I<sub>REF</sub> and DIF Clock (HCSL) Output Current**

Board Trace Impedance Z	Reference R <sub>IREF</sub> I <sub>REF</sub> = (1.1V) / (R <sub>IREF</sub> )	Output Current (mA)	V <sub>OH</sub> at Z
100Ω	R <sub>IREF</sub> = 475Ω (1%) I <sub>REF</sub> = 2.32mA	I <sub>OH</sub> = (6mA × I <sub>REF</sub> )	0.7V @ 50Ω
85Ω	R <sub>IREF</sub> = 412Ω (1%) I <sub>REF</sub> = 2.67mA	I <sub>OH</sub> = (6mA × I <sub>REF</sub> )	0.7V @ 42.2Ω

**Table 3. Resistive Lumped Test Loads for HCSL Differential Clocks**

Clock	Board Trace Impedance	R <sub>S</sub>	R <sub>P</sub>	R <sub>IREF</sub>	Units	Notes
Clocks (100MHz and 133.33MHz) with 50Ω configuration	100	33 (5%)	49.9 (1%)	475 (1%)	Ω	10in. (maximum) into 2pF load with 100Ω differential impedance.
Clocks (100MHz and 133.33MHz) with 42.5Ω configuration	85	27 (5%)	42.2 (1%)	412 (1%)	Ω	10in. (maximum) into 2pF load with 85Ω differential impedance.

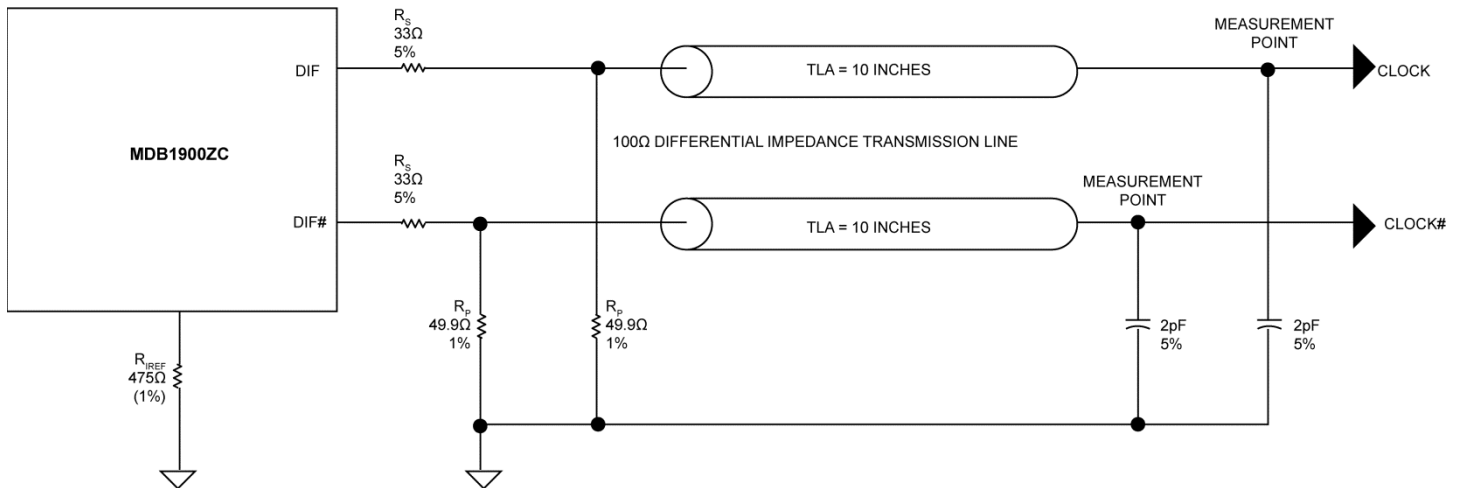

**Figure 5. 0.7V Configuration Test Load Board Termination with 100Ω Differential Impedance Transmission Line**

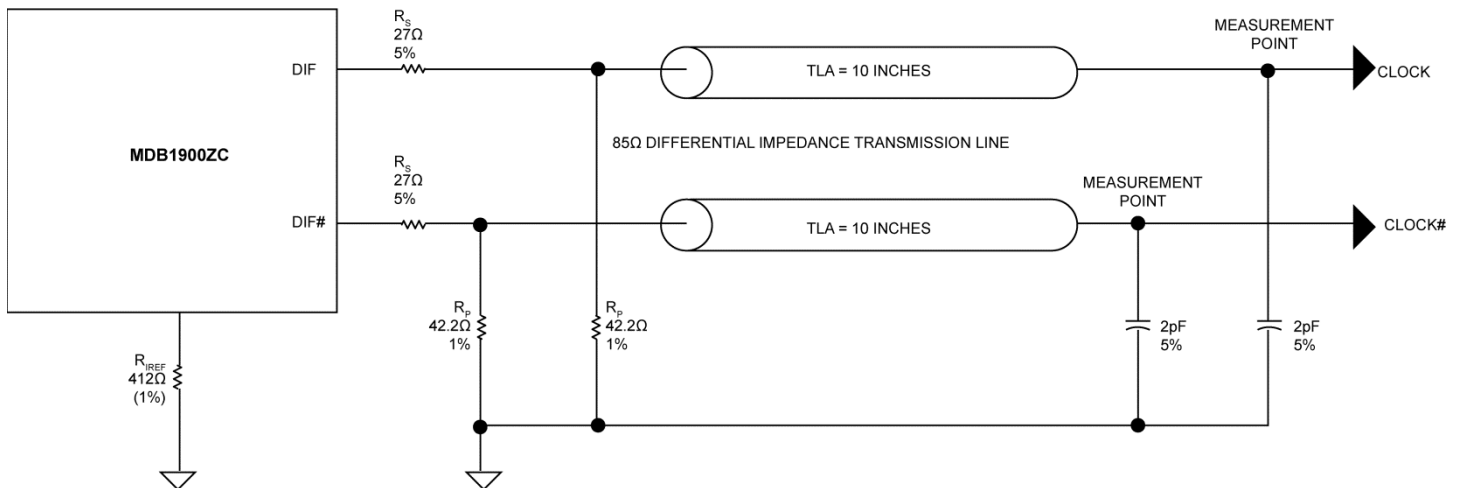

**Figure 6. 0.7V Configuration Test Load Board Termination with 85Ω Differential Impedance Transmission Line**

## Functional Description

### CLK\_IN, CLK\_IN# Input Reference

The reference clock (CLK\_IN, CLK\_IN#) is an HCSL (0.7V) differential input with 100MHz or 133.33MHz frequency from CK410B+, CK509B, or CK420BQ clock Synthesizer. The input (CLK\_IN, CLK\_IN#) has the option to have spread spectrum ON or spread spectrum OFF. The spread spectrum clocking (SSC) has modulation frequency value of 30kHz to 33kHz, with modulation of -0.5% down-spread (maximum). The modulation profile is Triangular or Lexmark.

### OE# and Output Enables (Control Registers)

OE# pins are dedicated control pins for DIF [12:5] outputs and are asynchronous asserted-low signals. Each output can be individually enabled or disabled by SMBus control register bits. The output enable bits in the SMBus registers are active high and by default are set to enable.

### OE# Assertion (Transition from Logic 1 to Logic 0)

All differential outputs that were tri-stated are to resume normal operation in a glitch free manner. The latency from the assertion to active outputs is 4 – 12 DIF clock periods.

### OE# De-Assertion (Transition from Logic 0 to Logic 1)

The impact of de-asserting OE# is each corresponding differential output will transition from normal operation to tri-state in a glitch free manner. A minimum of four valid clocks will be provided after OE# de-assertion. The maximum latency from the de-assertion to tri-stated outputs is twelve DIF clock periods.

**Table 4. OE Functionality**

Inputs		OE# Hardware Pins and Control Register Bits				Outputs	PLL State
PWRGD/ PWRGD#	CLK_IN/ CLK_IN#	SMBus Enable Bit	OE #	DIF/DIF#_ [12:5]	DIF/DIF#_ [18:13], [4:0]	FB_OUT/ FB_OUT#	
0	X	X	X	Hi-Z	Hi-Z	Hi-Z	ON
1	Running	0	X	Hi-Z	Hi-Z	Running	ON
		1	0	Running	Running	Running	ON
		1	1	Hi-Z	Running	Running	ON

### 100M\_133M# (Frequency Selection)

The 100M\_133M# is a hardware pin which programs the appropriate output frequency. The MDB1900ZC is operated in the 1:1 mode only; therefore the CLK\_IN frequency is equal to DIF [18:0] frequency. The frequency selection can be enabled by 100M\_133M# pin or by SMBus control register bit.

**Note:** The default frequency at power-up is 100MHz.

**Table 5. Frequency Program**

100M_133M#	Optimized Frequency (CLK_IN = DIF_[18:0])
0	133.33MHz
1	100.00MHz (Default)

### PWRGD/PWRDN#

De-assertion of PWRGD (Logic 0) which becomes PWRDN# indicates a power-down mode, which will shut off all clocks cleanly. PWRDN# is asynchronous active low input, and instructs the device to enter power saving mode. PWRDN# should be asserted low prior to shutting off the input clock or power to ensure all clocks shut down in a glitch-free manner, and all outputs will be tri-stated.

**Table 6. PWRGD/PWRGDN# Functionality**

PWRGD/ PWRGDN#	DIF_/DIF# [18:0]	Notes
0	Tri-State	Power-Down Mode
1	Normal	Active Mode

### PWRGD Assertion

The power-up latency is less than 1.8ms. This is the time from the assertion of the PWRGD pin or the ramping of the power supply and the time from valid CLK\_IN input clock until the time that stable clocks are output from the buffer chip (PLL locked).

The assertion and de-assertion of PWRDN# is absolutely asynchronous

**Note:** It is not recommended to disable (CLK\_IN, CLK\_IN#) input prior to assertion of PWRDN# and operation in this mode can result in glitches and excessive frequency shifting.

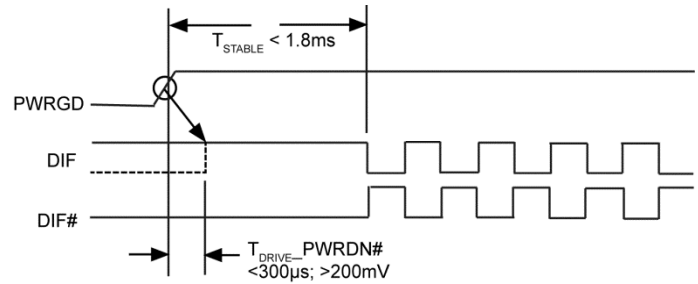

**Figure 7. PWRGD Assertion (Power-Down De-Assertion)**

### PWRDN# Assertion

When PWRDN# is sampled as being asserted by two consecutive rising edges of DIF#, all differential outputs must be tri-stated on the next DIF# high-to-low transition.

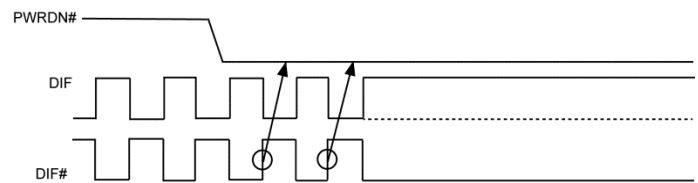

**Figure 8. PWRDN# Assertion**

### HBW\_BYPASS\_LBW#

The HBW\_BYPASS\_LBW# is a tri-level function input pin. It is used to select between PLL high-bandwidth, bypass mode and PLL low bandwidth. The PLL HBW, BYPASS and PLL LBW mode may be selected via writing to SMBus register or by asserting the HBW\_BYPASS\_LBW input pin to the appropriate level per Table 7.

**Table 7. PLL Bandwidth and Readback**

HBW_BYPASS_LBW#	Mode	Byte 0, Bit 7	Byte 0, Bit 6
L (Low)	LBW (Low PLL Bandwidth)	0	0
M (Mid)	BYPASS (Bypass PLL)	0	1
H (High)	HBW (High PLL Bandwidth)	1	1

**SA\_0, SA\_1 (Address Selection)**

SA\_0 and SA\_1 are tri-level hardware pins that can configure the MDB1900ZC to nine different addresses.

**Table 8. SA\_0, SA\_1, and SMBus Address**

SA_1	SA_0	SMBus Address
L	L	D8
L	M	DA
L	H	DE
M	L	C2
M	M	C4
M	H	C6
H	L	CA
H	M	CC
H	H	CE

## MDB1900ZC Control Registers

### SDA, SCL (Pins 12, 13)

The serial data (SDA) and serial clock (SCL) are dedicated for SMBus application and designed for 400Kb/s (maximum).

The SDA and SCL pins do not have internal pull-up resistors. When the device is in power-down mode, the SDA and SCL inputs are tri-stated and all programming information is retained.

All electrical characteristics meet the standard mode specifications of the SMBus 2.0 specification. For SDA and SCL input specs, refer to the [DC Electrical Characteristics](#)<sup>(6)</sup>.

**Table 9. Byte 0: Frequency Select, Output Enable, PLL-Mode Control Register**

Bit	Description	If Bit = 0	If Bit = 1	Type	Default	Pin(s)
7	HBW_BYPASS_LBW# Mode 1	Refer to <a href="#">Table 4</a>		R	Latched at Power-Up	5
6	HBW_BYPASS_LBW# Mode 0			R	Latched at Power-Up	5
5	Output Enable DIF, DIF#_18	Hi-Z	Enable	RW	1	71, 72
4	Output Enable DIF, DIF#_17	Hi-Z	Enable	RW	1	69, 70
3	Output Enable DIF, DIF#_16	Hi-Z	Enable	RW	1	66, 67
2	Reserved	–	–	–	–	–
1	Reserved	–	–	–	–	–
0	100M_133M# Frequency Select	133.33MHz	100MHz	R	Latched at Power-Up	4

**Table 10. Byte 1: Output Enable Control Register**

Bit	Description	If Bit = 0	If Bit = 1	Type	Default	Pin(s)
7	Output Enable DIF, DIF#_[7]	Hi-Z	Enabled	RW	1	38, 39
6	Output Enable DIF, DIF#_[6]	Hi-Z	Enabled	RW	1	35, 36
5	Output Enable DIF, DIF#_[5]	Hi-Z	Enabled	RW	1	32, 33
4	Output Enable DIF, DIF#_[4]	Hi-Z	Enabled	RW	1	29, 30
3	Output Enable DIF, DIF#_[3]	Hi-Z	Enabled	RW	1	27, 28
2	Output Enable DIF, DIF#_[2]	Hi-Z	Enabled	RW	1	24, 25
1	Output Enable DIF, DIF#_[1]	Hi-Z	Enabled	RW	1	22, 23
0	Output Enable DIF, DIF#_[0]	Hi-Z	Enabled	RW	1	19, 20

**Table 11. Byte 2: Output Enable Control Register**

Bit	Description	If Bit = 0	If Bit = 1	Type	Default	Pin(s)
7	Output Enable DIF, DIF#[15]	Hi-Z	Enabled	RW	1	64, 65
6	Output Enable DIF, DIF#[14]	Hi-Z	Enabled	RW	1	61, 62
5	Output Enable DIF, DIF#[13]	Hi-Z	Enabled	RW	1	59, 60
4	Output Enable DIF, DIF#[12]	Hi-Z	Enabled	RW	1	55, 56
3	Output Enable DIF, DIF#[11]	Hi-Z	Enabled	RW	1	52, 53
2	Output Enable DIF, DIF#[10]	Hi-Z	Enabled	RW	1	49, 50
1	Output Enable DIF, DIF#[9]	Hi-Z	Enabled	RW	1	46, 47
0	Output Enable DIF, DIF#[8]	Hi-Z	Enabled	RW	1	41, 42

**Table 12. Byte 3: OE# Pin Real-time Readback Control Register**

Bit	Description	If Bit = 0	If Bit = 1	Type	Default	Pin(s)
7	Real-Time Readback of OE_12#	OE_5# Low	OE_5# High	R	Real-Time	57
6	Real-Time Readback of OE_11#	OE_6# Low	OE_6# High	R	Real-Time	54
5	Real-Time Readback of OE_10#	OE_7# Low	OE_7# High	R	Real-Time	51
4	Real-Time Readback of OE_9#	OE_8# Low	OE_8# High	R	Real-Time	48
3	Real-Time Readback of OE_8#	OE_9# Low	OE_9# High	R	Real-Time	43
2	Real-Time Readback of OE_7#	OE_10# Low	OE_10# High	R	Real-Time	40
1	Real-Time Readback of OE_6#	OE_11# Low	OE_11# High	R	Real-Time	37
0	Real-Time Readback of OE_5#	OE_12# Low	OE_12# High	R	Real-Time	34



**Table 13. Byte 4: Reserved Control Register**

Bit	Description	If Bit = 0	If Bit = 1	Type	Default	Pin(s)
7	Reserved	–	–	–	–	–
6	Reserved	–	–	–	–	–
5	Reserved	–	–	–	–	–
4	Reserved	–	–	–	–	–
3	Reserved	–	–	–	–	–
2	Reserved	–	–	–	–	–
1	Reserved	–	–	–	–	–
0	Reserved	–	–	–	–	–

**Table 14. Byte 5: Vendor/Revision Identification Control Register**

Bit	Description	If Bit = 0	If Bit = 1	Type	Default	Pin(s)
7	Revision Code Bit 3	–	–	R	Vendor Specific (contact factory for details)	–
6	Revision Code Bit 2	–	–	R		–
5	Revision Code Bit 1	–	–	R		–
4	Revision Code Bit 0	–	–	R		–
3	Vendor ID Bit 3	–	–	R	0	–
2	Vendor ID Bit 2	–	–	R	0	–
1	Vendor ID Bit 1	–	–	R	1	–
0	Vendor ID Bit 0	–	–	R	1	–

**Table 15. Byte 6: Device ID Control Register**

Bit	Description	If Bit = 0	If Bit = 1	Type	Default	Pin(s)
7	Device ID 7 (MSB)	Device ID is 0xDB (Hex), or 219 (Decimal)		R	1	–
6	Device ID 6			R	1	–
5	Device ID 5			R	0	–
4	Device ID 4			R	1	–
3	Device ID 3			R	1	–
2	Device ID 2			R	0	–
1	Device ID 1			R	1	–
0	Device ID 0			R	1	–

**Byte 7: Byte Count Register**

Writing to bits [0:4] of Byte 7 configures how many bytes will be read back.

**Table 16. Byte 7: Byte Count Register**

Bit	Description	If Bit = 0	If Bit = 1	Type	Default	Pin(s)
7	Reserved	–	–	–	–	–
6	Reserved	–	–	–	–	–
5	Reserved	–	–	–	–	–
4	BC4	–	–	RW	0	–
3	BC3	–	–	RW	1	–
2	BC2	–	–	RW	0	–
1	BC1	–	–	RW	0	–
0	BC0	–	–	RW	0	–

**Byte 8, 9, 10: Access and Controls for Optional Advanced Features**

Registers 8, 9, and 10 are additional Micrel-defined registers to allow access to and control of optional advanced features. For optional features details, please see the [Optional Features](#) section.

Optional advanced features use a two level read or write access, wherein the first step is to enter an access code in Byte 8, followed by entering a feature's bit address in Byte 9, and then reading or writing control information in Byte 10.

**Byte 8: Advanced Features Access Register**

This is a write-only register which defines the access to Register 9 and 10. When value 0xBB('1011'1011) is written to Register 8, then Registers 9 and 10 become accessible. Otherwise, Registers 9 and 10 cannot be either read or written.

**Table 17. Byte 8: Advanced Features Access Register**

Bit	Description	If Bit = 0	If Bit = 1	Type	Default	Pin(s)
7	access[7]	–	–	W	–	–
6	access[6]	–	–	W	–	–
5	access[5]	–	–	W	–	–
4	access[4]	–	–	W	–	–
3	access[3]	–	–	W	–	–
2	access[2]	–	–	W	–	–
1	access[1]	–	–	W	–	–
0	access[0]	–	–	W	–	–

**Byte 9: Features Bits Address Register**

Each optional feature has an associate set of bits and each bit has a unique address. For details of optional features and their associated bit addresses, please see the *Optional Features* section. In order to access a bit, its address has to be written to Register 9.

**Table 18. Byte 9. Features Bits Address Register**

Bit	Description	If Bit = 0	If Bit = 1	Type	Default	Pin(s)
7	fbitaddr[7]	–	–	RW	–	–
6	fbitaddr[6]	–	–	RW	–	–
5	fbitaddr[5]	–	–	RW	–	–
4	fbitaddr[4]	–	–	RW	–	–
3	fbitaddr[3]	–	–	RW	–	–
2	fbitaddr[2]	–	–	RW	–	–
1	fbitaddr[1]	–	–	RW	–	–
0	fbitaddr[0]	–	–	RW	–	–

**Table 19. Byte 10: Optional Advanced Features Bits Command Register**

Bit	Description	If Bit = 0	If Bit = 1	Type	Default	Pin(s)
7	Write Enable	–	–	W	–	–
6	Feature Bit State (Read)	–	–	R	–	–
5	Reserved	–	–	–	–	–
4	Reserved	–	–	–	–	–
3	Reserved	–	–	–	–	–
2	Reserved	–	–	–	–	–
1	Feature Bit State (Write)	–	–	W	–	–
0	Reserved	–	–	–	–	–

**Byte 10: Features Bits Command Register**

To read or write a feature bit value, first write the 1011 1011 access code to byte 8 followed by the feature bit address to byte 9. The current value of the feature bit will appear in bit 6 of byte 10, where it can be read. To write the value of the feature bit, write the desired value into bit 1 of byte 10 and also set bit 7 of byte 10 to '1' to enable the writing. Next, write '0000 0000' to byte 10 to close writing before changing to another address in byte 9.

## Feature Bit Commands

### **READ: To Read a Current Feature Bit Value**

1. Write '1011'1011 to Register 8 (to enable Register 9 and 10).
2. Write the feature bit address to Register 9.
3. Read Register 10, the feature bit state is available in bit 6 of register 10.

#### **Example 1**

To read the LSB of the delay on CLK\_IN path (delay\_clkln[0], Address 132):

1. Write '1011'1011 to Register 8 (to enable Register 9 and 10).
2. Write '1000'0100 to Register 9 (Address 132).
3. Read Register 10, Bit 6 for the value of delay\_clkln[0].

#### **Example 2**

To read the MSB of output0 (Out0trim[3], Address 143, Default 1):

1. Write '1011'1011 to Register 8 (to enable Register 9 and 10).
2. Write '1000'1111 to Register 9 (Address 143).
3. Read Register 10, Bit 6 for the value of Out0trim[3].

### **WRITE: To change the Value of a Feature Bit**

1. Write '1011'1011 to Register 8 (to enable Register 9 and 10).
2. Write the feature bit address to Register 9.
3. Write '1000'00s0 to Register 10, where s is the feature bit value ('0' or '1').
4. Write '0000'0000 to Register 10 to close the write command.

#### **Example 1**

To set (write) the LSB of the delay on CLK\_IN path to 1 (delay\_clkln[0], Address 132):

1. Write '1011'1011 to Register 8 (to enable Register 9 and 10).
2. Write '1000'0000 to Register 9 (Address 132).
3. Write '1000'0010 to Register 10 for delay\_clkln[0]=1 or '1000'0000 for delay\_clkln[0]=0.
4. Write '0000'0000 to Register 10.

#### **Example 2**

To set (write) the MSB of output0 to 0 (Out0trim[3], Address 143, Default 1).

1. Write '1011'1011 to Register 8 (to enable Register 9 and 10).
2. Write '1000'1111 to Register 9 (Address 143).
3. Write '1000'0010 to register 10 for Out0trim[3]=1 or '1000'0000 for Out0trim[3]=0.
4. Write '0000'0000 to Register 10.

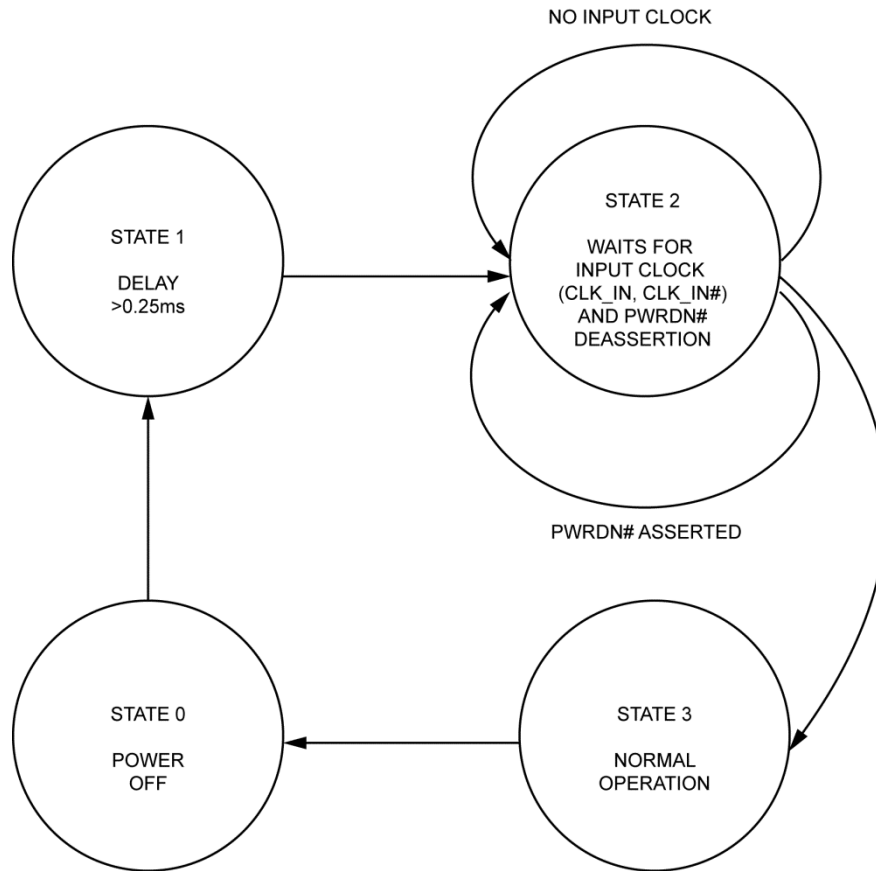

Figure 9. Buffer Power-Up State Diagram

Table 20. Buffer Power-Up State Machine

State	Description
0	Buffer power off.
1	After supply is detected to rise above 1.8 V - 2.0 V, the buffer enters (state 1) and initiates (>0.25ms - 0.3ms) delay.
2	Buffer waits for a valid (CLK_IN, CLK_IN#) and PWRDN# de-assertion.
3	After the PLL locked to input reference (CLK_IN, CLK_IN#), the buffer enters (State 3) and enables all outputs for normal operation. The total power-up latency is <1.8ms (assuming a valid clock is present on (CLK_IN, CLK_IN#) input. If power is valid and PWRDN# is de-asserted but no input (CLK_IN, CLK_IN#), therefore all DIF, DIF# [18:0] remain disabled. Only after input clock is detected, valid power, PWRDN# de-asserted with the PLL locked/stable and the DIF, DIF# are enabled.

## Optional Features

The MDB1900ZC is 100% compatible with the Intel DB1900Z specification document and can be used in any application where that part is called for. However, Micrel has made available optional features that are largely enabled through three additional registers (Registers 8, 9, and 10). These optional features allow for significant power savings and for coping with PCB manufacturing variability.

### 2.5V Operation

In addition to the 3.3V ( $\pm 5\%$ ) operation voltage called for by the Intel specification, the MDB1900ZC supports 2.5V ( $\pm 5\%$ ) operation voltage. No changes to registers or power supply filtering components are required to use this feature. Simply connect a 2.5V supply where the 3.3V supply is specified and the part will continue to work correctly, including all output voltages and levels. Switching to 2.5V from 3.3V will save approximately 25% in total power dissipation for this part.

### Zero Delay Optimization

The MDB1900ZC has excellent zero delay characteristics that are far better than required by the Intel specification. However, the exact value of the zero delay is partially dependent on the feedback path and this can vary with the PCB board design and with manufacturing variations in the PCB. To compensate for errors in the PCB design or to relax the manufacturing tolerance required from the PCB board vendor, Micrel has provided the ability to independently add delay into either or both the CLK\_IN path and the FB\_IN path (see [Table 21](#) and [Table 22](#)).

**Table 21. Feature Bit Address [135:132]  $\geq$  DELAY\_CLKIN[3:0]**

DELAY_CLKIN[3:0]	Additional Delay in CLK_IN Path (Typical Value with Respect to Default)	Unit
'0000 (Default)	–	ps
'0001	18	ps
'0010	29	ps
'0011	50	ps
'0100	68	ps
'0101	88	ps
'0110	101	ps
'0111	121	ps
'1000	141	ps
'1001	163	ps

**Table 22. Feature Bit Address [139:136] ≥ DELAY\_FB[3:0]**

<b>DELAY_FB[3:0]</b>	<b>Additional Delay in FB_IN Path (Typical Value with Respect to Default)</b>	<b>Unit</b>
'0000 (Default)	–	ps
'0001	18	ps
'0010	29	ps
'0011	50	ps
'0100	68	ps
'0101	88	ps
'0110	101	ps
'0111	121	ps
'1000	141	ps
'1001	163	ps

## Input Signal Pin Capacitance

The zero delay value is defined not only by the external feedback path but also by the input pin capacitance driven by that feedback path. The input pin capacitance is allowed by the Intel specification to be within a fairly broad range. The Micrel part is always within the low end of the allowed range ensuring a low capacitive load and sharp edge rates. However, the user can adjust the MDB1900ZC so that it presents a larger input capacitance load at CLK\_IN, CLK\_IN#, FB\_IN, FB\_IN#.

This feature can be used to ensure compatibility with third-party vendors who can still meet the Intel specification, but have significantly different input capacitances (see [Table 23](#) and [Table 24](#)).

**Table 23. Feature Bit Address [218:216] ≥ INPUT\_CAP\_CLKIN[2:0]**

INPUT_CAP_CLKIN[2:0]	Input Capacitance (Typical Value)	Unit
'000 (Default)	2.46	pF
'001	2.82	pF
'010	3.24	pF
'011	3.58	pF
'100	4.02	pF
'101	4.34	pF
'110	4.77	pF
'111	5.12	pF

**Table 24. Feature Bit Address [221:219] ≥ INPUT\_CAP\_FBIN[2:0]**

INPUT_CAP_FBIN[2:0]	Input Capacitance (Typical Value)	Unit
'000 (Default)	2.46	pF
'001	2.82	pF
'010	3.24	pF
'011	3.58	pF
'100	4.02	pF
'101	4.34	pF
'110	4.77	pF
'111	5.12	pF



## Bypass Delay

The Intel specification calls for a fairly long delay of 2.5ns when the PLL is in bypass mode. The MDB1900ZC fully meets this specification in default mode. However, if the user wishes to have a much shorter bypass delay of 0.9ns this feature can be enabled.

### Output Drive Levels

The Intel specification calls for very specific current drive levels on each of the HCSL outputs based on whether the part is driving 85Ω traces or 100Ω traces.

The specification calls for all enabled outputs to drive at the same current level. However, the MDB1900ZC allows the user to independently control the current drive to each output. This feature can be used to selectively save power on lightly loaded or short traces where  $V_{OH}$ ,  $V_{OL}$  and edge rate can readily be met with reduced current without impacting other traces.

**Table 25. Feature Bit Address [222] ≥ DELAY\_BYPASS**

Delay Bypass	Input-to-Output Delay – PLL Bypass Mode (Typical Value)	Unit
'0 (Default)	2.5	ns
'1	0.9	ns

**Table 26. Feature Bit Address [215:140] ≥ Output Drive Level**

Output	Feature Bit Address	Feature Bits
0	Address[143:140]	Out0trim[3:0]
1	Address[147:144]	Out1trim[3:0]
2	Address[151:148]	Out2trim[3:0]
3	Address[155:152]	Out3trim[3:0]
4	Address[159:156]	Out4trim[3:0]
5	Address[163:160]	Out5trim[3:0]
6	Address[167:164]	Out6trim[3:0]
7	Address[171:168]	Out7trim[3:0]
8	Address[175:172]	Out8trim[3:0]
9	Address[179:176]	Out9trim[3:0]
10	Address[183:180]	Out10trim[3:0]
11	Address[187:184]	Out11trim[3:0]
12	Address[191:188]	Out12trim[3:0]
13	Address[195:192]	Out13trim[3:0]
14	Address[199:196]	Out14trim[3:0]
15	Address[203:200]	Out15trim[3:0]
16	Address[207:204]	Out16trim[3:0]
17	Address[211:208]	Out17trim[3:0]
18	Address[215:212]	Out18trim[3:0]

**Table 27. Output Drive Level, Output Trim Feature Bits Definition (also refer to Table 26)**

Output Trim Feature Bits [3:0]	Output Drive Level (Relative to Default)	Output Current 100Ω Loads (mA)	Output Current 85Ω Loads (mA)
'0000 (Default)	100%	14.0	16.0
'0001	90%	12.6	14.4
'0011	80%	11.2	12.8
'0100	70%	9.8	11.2
'0110	60%	8.4	9.6
'0111	50%	7.0	8.0
'1010	40%	5.6	6.4
'1011	30%	4.2	4.8
'1100	20%	2.8	3.2
'1110	10%	1.4	1.6
'1111	0%	0.0	0.0

**Example of Setting Output 1 to 60% Strength (change from default 100%)****Feature Bits: out1trim[3:0], address[147:144]**

In order to set output1 to 60% strength, out1trim[3:0] needs to be '0110. Therefore, feature bits 145 and 146 need to be inverted:

1. Write '1011'1011 to Register 8 (to enable Register 9 and 10)
2. Write '1001'0001 to Register 9 (Feature Bit 145)
3. Write '1000'0010 to Register 10 (set Feature Bit 145 to 1)
4. Write '0000'0000 to Register 10
5. Write '1001'0010 to Register 9 (Feature Bit 146)
6. Write '1000'0010 to Register 10 (set Feature Bit 146 to 1)
7. Write '0000'0000 to Register 10

# Package Information and Recommended Land Pattern<sup>(41)</sup>

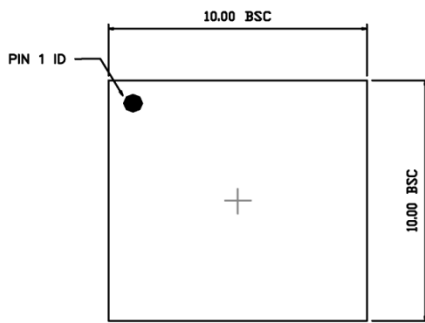

**TOP VIEW**  
NOTE 1, 2, 3

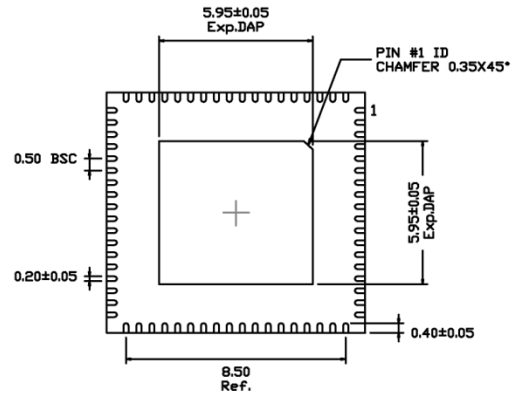

**BOTTOM VIEW**  
NOTE 1, 2, 3

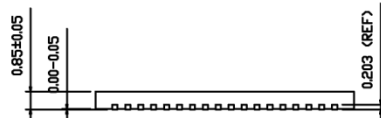

**SIDE VIEW**  
NOTE 1, 2, 3

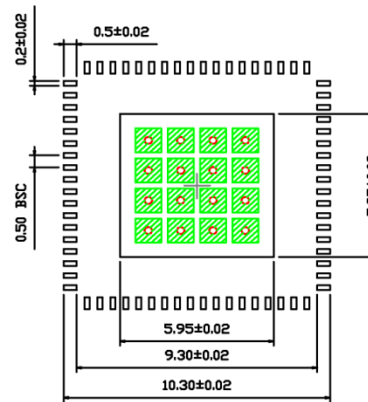

**RECOMMENDED LAND PATTERN**  
NOTE 4, 5

**NOTE:**

1. MAX PACKAGE WARPAGE IS 0.05mm.
2. MAX ALLOWABLE BURR IS 0.076mm IN ALL DIRECTIONS.
3. PIN #1 IS ON TOP WILL BE LASER MARK.
4. RED CIRCLES IN LAND PATTERN INDICATES THERMAL VIA. SIZE SHOULD BE 0.30-0.3mm IN DIAMETER AND SHOULD BE CONNECTED TO GND FOR MAX THERMAL PERFORMANCE. 1.0MM PITCH
5. GREEN RECTANGLES (SHADED AREA) REPRESENT SOLDER STENCIL OPENING ON EXPOSED PAD AREA. RECOMMENDED SIZE IS 1.0x1.0mm, SPACING IS 0.25mm.

**Note:**

41. Package information is correct as of the publication date. For updates and most current information, go to: [www.micrel.com](http://www.micrel.com).

---

**MICREL, INC. 2180 FORTUNE DRIVE SAN JOSE, CA 95131 USA**  
TEL +1 (408) 944-0800 FAX +1 (408) 474-1000 WEB <http://www.micrel.com>

Micrel, Inc. is a leading global manufacturer of IC solutions for the worldwide high-performance linear and power, LAN, and timing & communications markets. The Company's products include advanced mixed-signal, analog & power semiconductors; high-performance communication, clock management, MEMs-based clock oscillators & crystal-less clock generators, Ethernet switches, and physical layer transceiver ICs. Company customers include leading manufacturers of enterprise, consumer, industrial, mobile, telecommunications, automotive, and computer products. Corporation headquarters and state-of-the-art wafer fabrication facilities are located in San Jose, CA, with regional sales and support offices and advanced technology design centers situated throughout the Americas, Europe, and Asia. Additionally, the Company maintains an extensive network of distributors and reps worldwide.

Micrel makes no representations or warranties with respect to the accuracy or completeness of the information furnished in this datasheet. This information is not intended as a warranty and Micrel does not assume responsibility for its use. Micrel reserves the right to change circuitry, specifications and descriptions at any time without notice. No license, whether express, implied, arising by estoppel or otherwise, to any intellectual property rights is granted by this document. Except as provided in Micrel's terms and conditions of sale for such products, Micrel assumes no liability whatsoever, and Micrel disclaims any express or implied warranty relating to the sale and/or use of Micrel products including liability or warranties relating to fitness for a particular purpose, merchantability, or infringement of any patent, copyright, or other intellectual property right.

Micrel Products are not designed or authorized for use as components in life support appliances, devices or systems where malfunction of a product can reasonably be expected to result in personal injury. Life support devices or systems are devices or systems that (a) are intended for surgical implant into the body or (b) support or sustain life, and whose failure to perform can be reasonably expected to result in a significant injury to the user. A Purchaser's use or sale of Micrel Products for use in life support appliances, devices or systems is a Purchaser's own risk and Purchaser agrees to fully indemnify Micrel for any damages resulting from such use or sale.

© 2014 Micrel, Incorporated.