

# FTS250-HP GPS Disciplined Oscillator



2111 Comprehensive Drive  
Aurora, Illinois 60505  
Phone: 630-851-4722  
Fax: 630-851-5040  
www.conwin.com

D  
A  
T  
A  
S  
H  
E  
E  
T

**Connor-Winfield's** GPS Disciplined Oscillators (GPSDOs) were created specifically for precision timing, synchronization and time stamping applications requiring high end, cost sensitive solutions. By combining our uniquely designed phase lock loop circuitry, a GPS/GNSS receiver and our high-quality oscillators, Connor Winfield is able to offer a wide variety of superior, cost-effective GPS timing solutions. The FTS250-HP Series modules provide customer applications with the precise timing capabilities needed to optimize critical system performance.

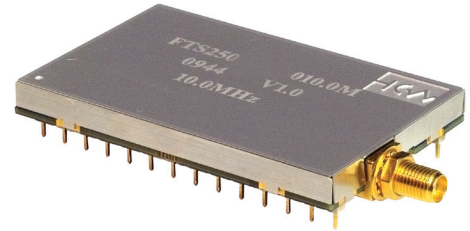

## General Description

The FTS250-HP-010.0M Frequency and Time Standard module is a GPS/GNSS driven, mixed-signal phase lock loop, providing a 1 PPS CMOS output from an onboard GPS/GNSS timing receiver. The FTS250-HP generates a 10 MHz CMOS and a 10 MHz SINE output from an intrinsically low jitter voltage controlled crystal oscillator. The FTS250-HP locks to a 1 PPS reference derived from the onboard GPS receiver from which it generates the 10MHz outputs and the 1PPS output.

The module can also be programmed to lock to an external 10 MHz reference or to an external 1 PPS reference. Alarms are provided to indicate Loss-of-Lock, Holdover, and Antenna Fault status. The onboard GPS receiver requires an outdoor mounted GPS antenna for the best stability and consistent performance. The mode control inputs are used to manually switch between references and/or holdover. The user application should monitor the alarm outputs and manually switch modes as needed.

Serial I/O lines provide access to the NMEA messages from the GPS receiver. The serial I/O lines can be used to access GPS timestamp information, or to verify that the receiver has recovered from an alarm condition. The reset is used to reset the GPS receiver (if needed).

## Features

- Phase locked 10 MHz output (other frequencies available upon request)
- Phase locked 1 PPS output
- Three selectable references: GPS, External 10 MHz or External 1 PPS
- Multiple Holdover Thermal Stability Options
- Three alarm outputs. (Loss-of-Lock, Holdover and Antenna Fault)
- Serial input and output ports (GPS receiver)
- Master reset
- +3.3 Volt power supply
- Temperature Range: -40°C to 85°C
- Meets ITU-T G.811 Wander Generation Mask
- SMA Bulkhead GPS Antenna Connection
- Package: 28-pin Through-Hole
- Physical Dimensions: 2.8" x 1.725" x 0.368" (71mm x 43.82mm x 9.34mm)
- Fixed Position
- Multiple Output Frequency Options in addition to 10MHz.

## Functional Block Diagram

Figure 1

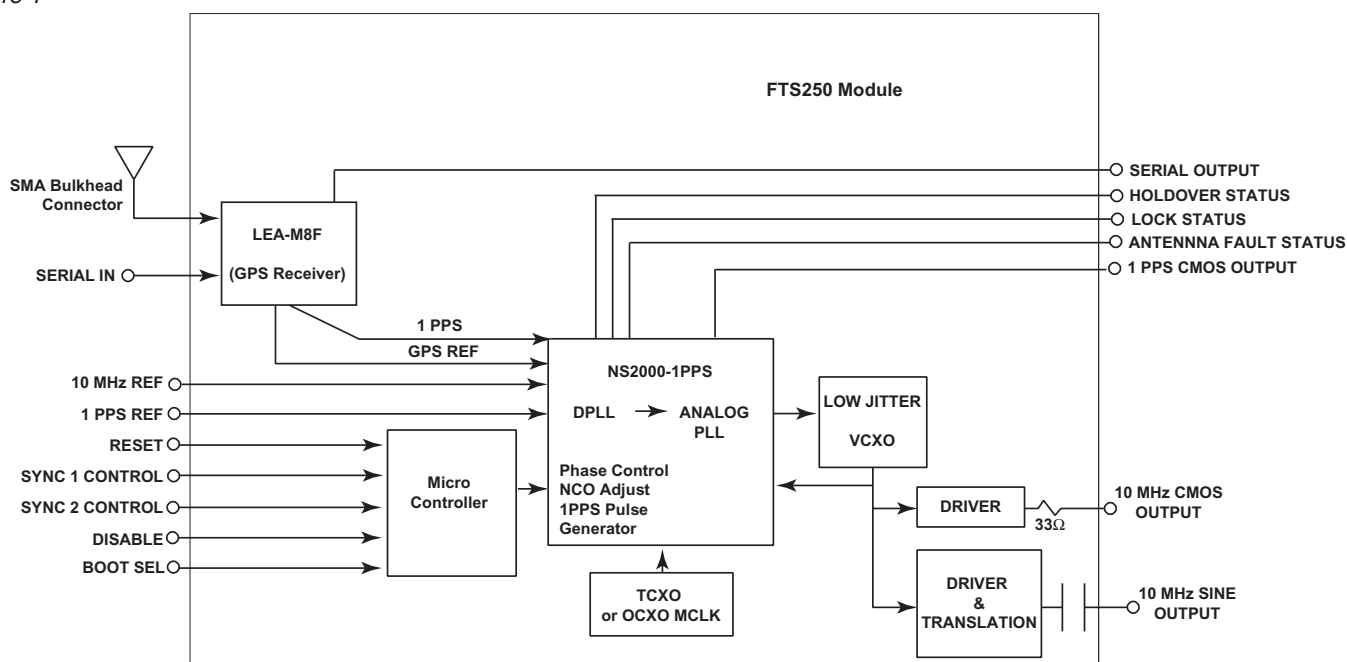

### Pin Description

Table 1

| Pin # | Pin Name               | Description  | Note |
|-------|------------------------|--|------|
| 1     | Vcc2                   | 3.3V ±5% Supply Voltage  |      |
| 2     | GND                    |  |      |
| 3     | *Reset                 | Hardware Reset for GPS Circuitry. Pull low to Reset                            | 1    |
| 4     | *Disable               | Open/High = Enabled Outputs. Low = Disabled Outputs                            | 1    |
| 5     | 1 PPS Ref Input        | External 1 PPS reference   | 1    |
| 6     | GND                    |  |      |
| 7     | 10 MHz Ref Input       | External LVCMOS 10 MHz Reference   | 1    |
| 8     | NU                     | Used for Factory Programming   |      |
| 9     | NU                     | Used for Factory Programming   |      |
| 10    | NU                     | Used for Factory Programming   |      |
| 11    | NU                     | Used for Factory Programming   |      |
| 12    | *Bootssel              | Normally High - Pulled low during Wi125 software updates                       |      |
| 13    | GND                    |  |      |
| 14    | Vcc1                   | 3.3V ±5% Supply Voltage  | 2    |
| 15    | Antenna Supply Voltage | 2.7 to 13.2V Input Supply Voltage for the Antenna. Max 45mA continuous current |      |
| 16    | GND                    |  |      |
| 17    | RXA                    | RS-232 Communication receive signal for UART-0                                 |      |
| 18    | TXA                    | RS-232 Communication transmit signal for UART-0                                |      |
| 19    | SYNC2 Control          | Lock mode selection control signal 2   | 1    |
| 20    | SYNC1 Control          | Lock mode selection control signal 1   | 1    |
| 21    | Lock Status            | High = Unit is locked to the selected reference                                | 1    |
| 22    | Holdover Status        | High = Unit is in Holdover   | 1    |
| 23    | Antenna Fault Status   | High = Fault detected on the Antenna Supply Voltage (Self Clearing)            | 1    |
| 24    | 1 PPS CMOS Output      | 1 PPS LVCMOS Output  | 1    |
| 25    | GND                    |  |      |
| 26    | 10 MHz CMOS Output     | 10 MHz LVCMOS Output (Default)   | 1, 3 |
| 27    | GND                    |  |      |
| 28    | 10 MHz SINE Output     | 10 MHz Sine Output (~-9dBm)  |      |

Note: 1. 3.3 VDC (LVCMOS) compatible  
 2. If OCXO option is chosen, must add OCXO current to this base current.

## Absolute Maximum Rating

Table 2

| Symbol              | Parameter              | Minimum | Maximum | Units | Notes |
|---------------------|------------------------|---------|---------|-------|-------|
| V <sub>CC</sub>     | Power Supply Voltage   | -0.3    | 3.7     | Volts | 1     |
| V <sub>IN</sub>     | Input Voltage          | -0.3    | 4.6     | Volts | 1     |
| V <sub>PREAMP</sub> | Antenna Supply Voltage | 2.7     | 13.2    | Volts | 1     |
| T <sub>S</sub>      | Storage Temperature    | -40     | 85      | °C    | 1     |

## Operating Specifications

Table 3

| Symbol              | Parameter                       | Minimum | Nominal | Maximum | Units | Notes |
|---------------------|---------------------------------|---------|---------|---------|-------|-------|
| V <sub>CC1</sub>    | Supply Voltage 1                | 3.135   | 3.3     | 3.465   | V     | 2     |
| I <sub>CC1</sub>    | Supply Current 1                |         | 0.270   |         | A     |       |
| V <sub>CC2</sub>    | Supply Voltage 2                | 3.135   | 3.3     | 3.465   | V     | 2     |
| I <sub>CC2</sub>    | Supply Current 2                |         | 0.036   |         | A     |       |
| T <sub>O</sub>      | Temperature Range               | -40     |         | 85      | °C    |       |
| t <sub>JTOL</sub>   | Input Jitter Tolerance          | 30      |         |         | ns    |       |
| t <sub>AQ_GPS</sub> | GPS Input Acquisition Time      |         | 100     |         | sec   | 3     |
| t <sub>AQ_EXT</sub> | External Input Acquisition Time |         | 100     |         | sec   | 3     |

### Oscillator Performance

|                  |                         |                                       |  |  |     |
|------------------|-------------------------|---------------------------------------|--|--|-----|
| F <sub>CAP</sub> | Capture/Pull-in Range   | Dependent upon holdover option chosen |  |  | ppm |
| F <sub>BW</sub>  | Jitter Filter Bandwidth | 0.8                                   |  |  | Hz  |
| DC               | Duty Cycle              | 45/55                                 |  |  | %   |
| RMS              | RMS Phase Noise         |                                       |  |  |     |
|                  | 10 Hz - 2 MHz           | 1.2                                   |  |  | ps  |
|                  | 12 kHz - 2 MHz          | 0.6                                   |  |  |     |

### Holdover/Wander Generation Performance

|  |                                 |                                    |  |  |     |   |
|--|---------------------------------|------------------------------------|--|--|-----|---|
|  |                                 |                                    |  |  | 4   |   |
|  | Frequency Stability             | See Holdover Specification Options |  |  | ppm | 5 |
|  | Wander Generation Specification | ITU-T G.811                        |  |  |     |   |

**NOTES:**

1. Stresses beyond those listed under "Absolute Maximum Rating" may cause permanent damage to the module. These are stress ratings only and functional operation of the device at these or any other conditions beyond those indicated under "Operating Specifications" is not implied. Exposure to absolute maximum rated conditions for extended periods may affect device reliability.
2. Requires external regulation and supply decoupling.
3. Cold Power-up.
4. Holdover will be re-calculated with each successful lock. Yearly aging represents 1 continuous year in Holdover.
5. Includes unidirectional temperature stability, Vcc stability, and 24 hours of aging.

## Mode Control Table

Table 4

| SYNC 1 | SYNC 2 | Operating Mode                     |
|--------|--------|------------------------------------|
| 0      | 0      | Force Holdover                     |
| 0      | 1      | Lock to External 10 MHz reference* |
| 1      | 0      | Lock to External 1 PPS reference   |
| 1      | 1      | (Default) Lock to GPS Signal       |

\* Note: Holdover is not supported in this mode; loss of the 10MHz reference will rail the PLL output until the reference returns or another mode is selected.

## Input And Output Characteristics

Table 5

| LVCMOS Inputs and Outputs |                           |         |         |       |       |
|---------------------------|---------------------------|---------|---------|-------|-------|
| Symbol                    | Parameter                 | Minimum | Maximum | Units | Notes |
| V <sub>IH</sub>           | High Level Input Voltage  | 1.7     | 4.0     | V     |       |
| V <sub>IL</sub>           | Low Level Input Voltage   | -0.5    | 0.8     | V     |       |
| V <sub>OH</sub>           | High Level Output Voltage | 2.4     |         | V     |       |
| V <sub>OL</sub>           | Low Level Output Voltage  |         | 0.4     | V     |       |
| C <sub>O</sub>            | Output Capacitance        |         | 10      | pF    |       |

| 10 MHz Sine Output |                           |         |  |                 |       |
|--------------------|---------------------------|---------|--|-----------------|-------|
| Symbol             | Parameter                 | Typical |  | Units           | Notes |
|                    | Load                      | 50      |  | ohms            |       |
|                    | Output Power              | 9       |  | dB <sub>m</sub> |       |
|                    | Total Harmonic Distortion | 2.2     |  | %               |       |

## GPS Receiver Specifications

Table 6

| Parameter           | Specifications            | Notes             |
|---------------------|---------------------------|-------------------|
| Time to First Fix:  | Cold:                     | 29 sec            |
|                     | Aided Cold Start          | <2 sec            |
|                     | Timing Fix:               | Additional 15 sec |
| Sensitivity         | Acquisition/Tracking      | -165dBm           |
|                     | Aided Acquisition         | -157dBm           |
|                     | Re-acquisition            | -160dBm           |
|                     | Cold Start                | -148dBm           |
| Supported Protocols | Network Assist, NMEA 0183 |                   |

## Reset Generation (I/O pin 3 - RESET)

The power-on-reset for the FTS250-HP is generated on-board. If it is desired to extend the power-on-reset signal or provide a manual reset of the GPS receiver, pull this signal low.

## Antenna Requirements

Table 7

| Parameter   | Notes |
|---|-------|
| The FTS250-HP antenna connector is a SMA Bulkhead (female)  |       |
| The antenna supply voltage provided to Pin 15 must be within the range of 2.7 to 13.2V (AMR); the antenna must be able to operate at this voltage |       |
| The antenna's continuous current draw must be $\leq 45\text{mA}$  |       |
| The antenna must have a full sky view for optimal receiver performance  |       |
| An active antenna with a minimum 10dB gain (including cable loss) should be used  |       |

*FTS250-HP Series Models are designed for fix position operation only. Specifications are based on fixed position operation.*

## Phase Noise

Figure 2

| Phase Noise:          |            |
|-----------------------|------------|
| Offset Frequency (Hz) | (dBc/Hz)   |
| 10                    | -90 (Typ)  |
| 100                   | -125 (Typ) |
| 1k                    | -138 (Typ) |
| 10k                   | -142 (Typ) |
| 100k                  | -150 (Typ) |
| 1M                    | -152 (Typ) |

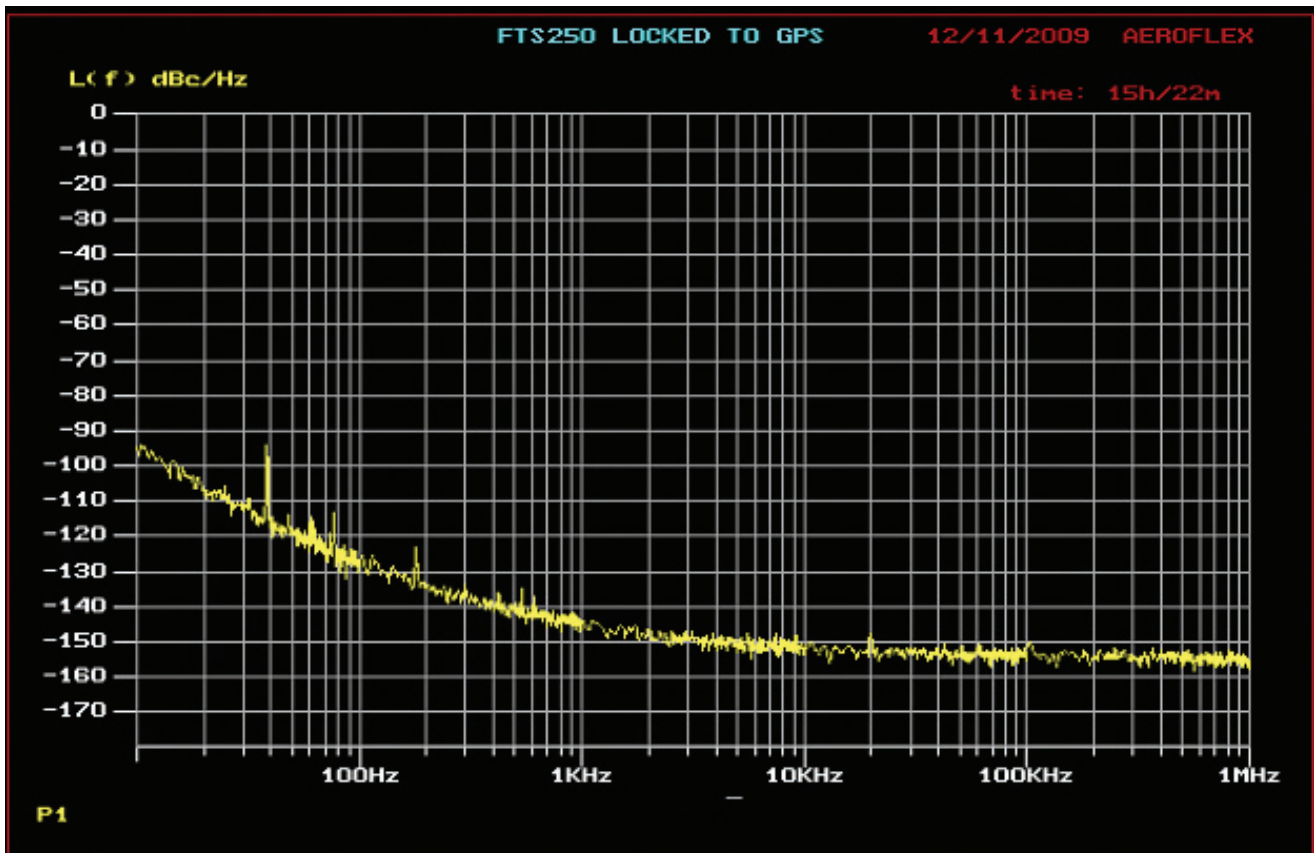

Allan Variance  
Figure 3

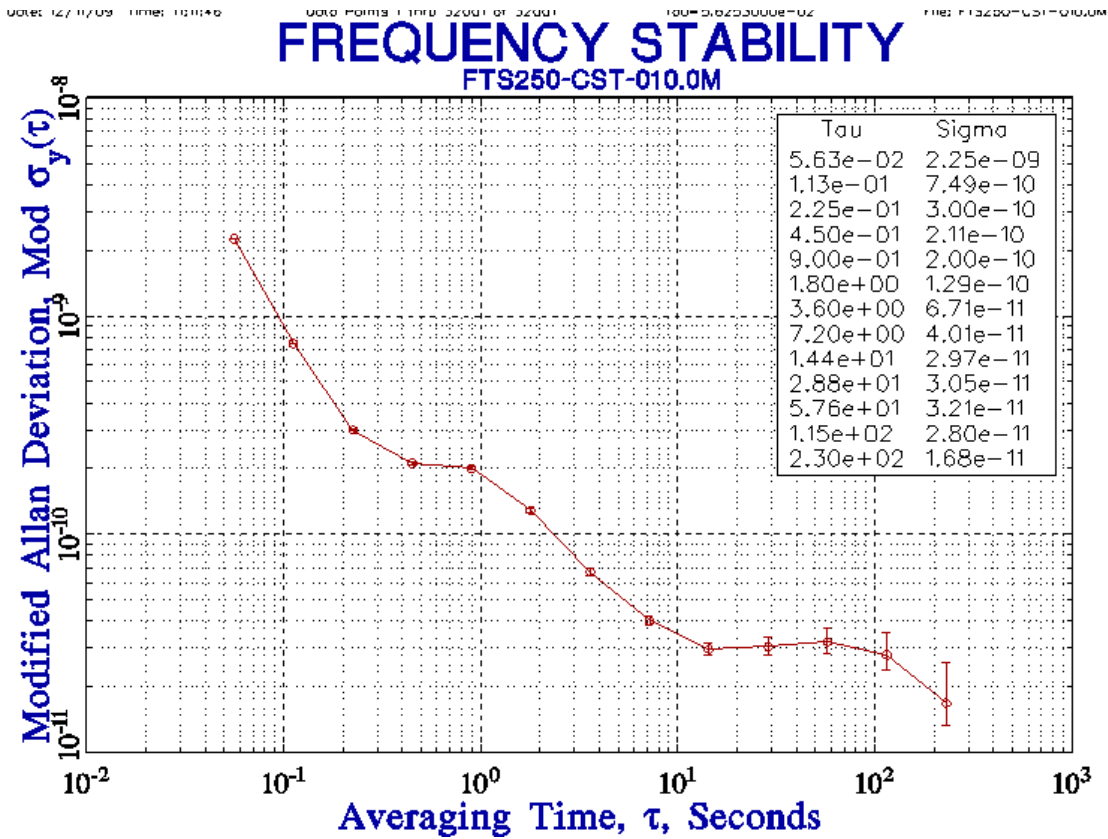

Wander Generation Plot – FTS250-HP versus G.811 Wander Generation Mask  
Figure 4

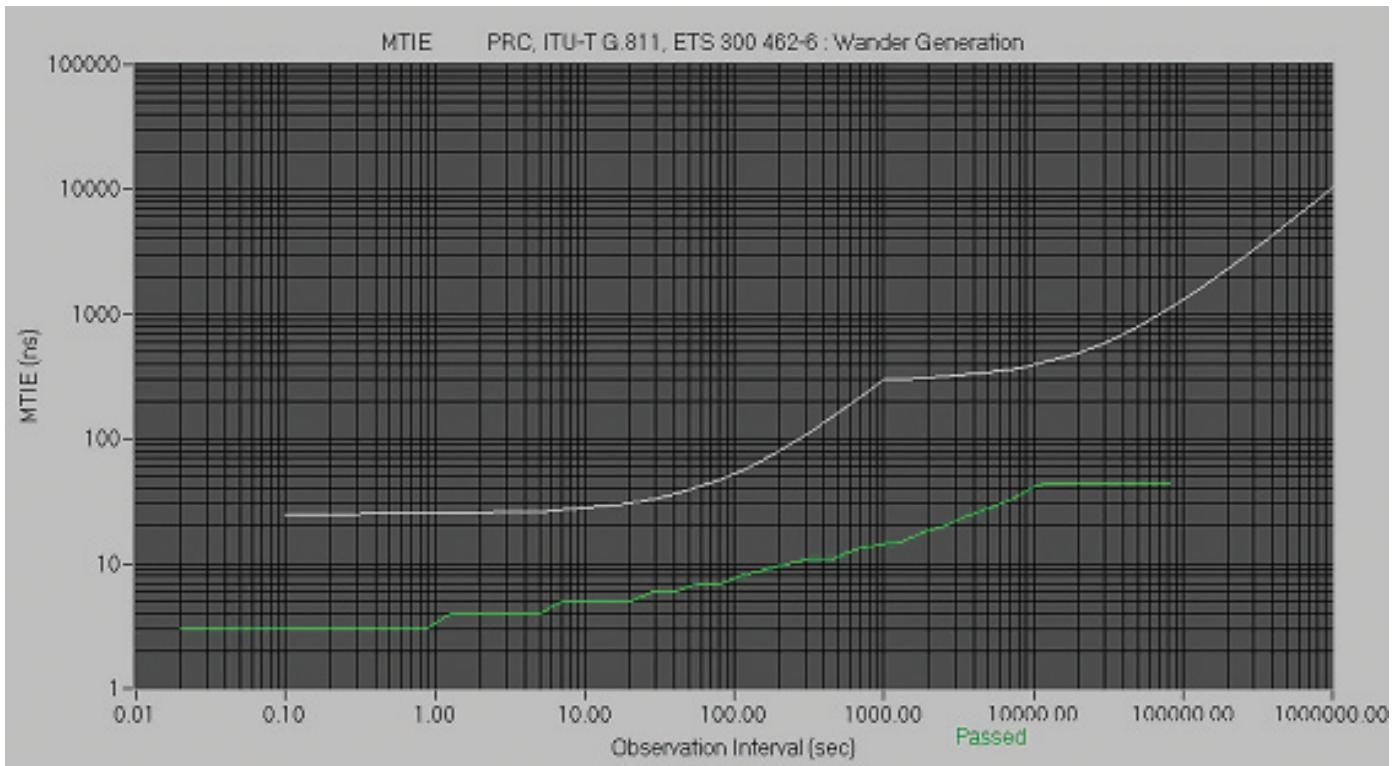

## Soldering and Cleaning Recommendations

Hand solder, leaded wave solder, and lead-free wave solder processes are recommended for attaching the FTS250-HP after reflow processes are complete. Since the FTS250-HP does not have hermetic enclosure, hand cleaning the leads is recommended and the module should not be completely immersed.

## Package Dimensions

Figure 5

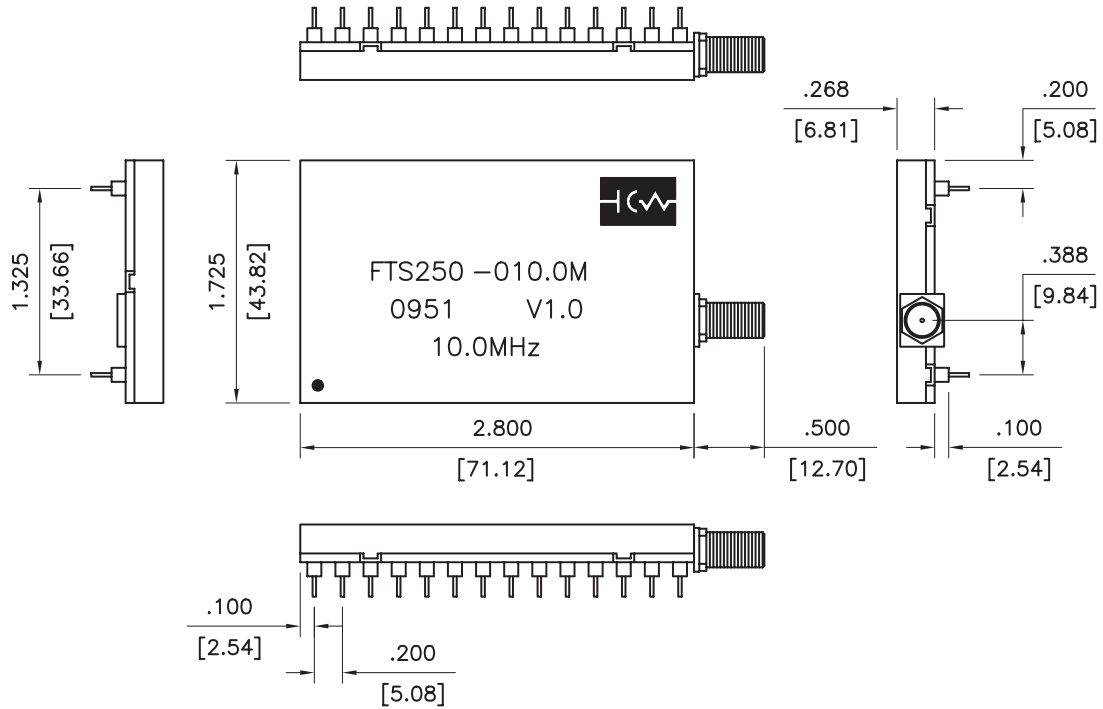

## Top View Dimensions & Keep-out Area

Figure 6

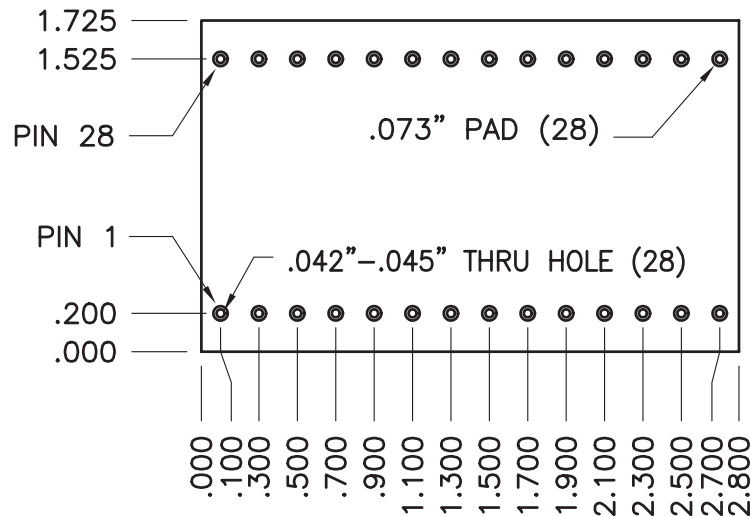



# FTS250-HP GPS Disciplined Oscillator

Available at Digi-Key  
www.digikey.com

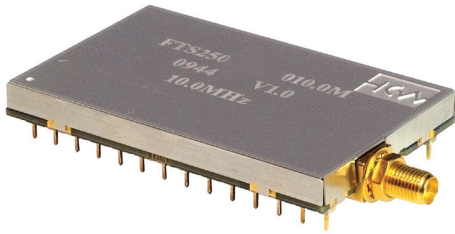

2111 Comprehensive Drive  
Aurora, Illinois 60505  
Phone: 630-851-4722  
Fax: 630-851-5040  
www.conwin.com

## Ordering Information

FTS250-HP      -T1      -010.0M\*

\*Output Frequencies from 10Hz to 160MHz available upon request.

TCXO Holdover Specification Options based on a choice of TCXO model number used on module Thermal Stability Options:

|             |         |             |   |
|-------------|---------|-------------|---|
| -T1: T200F: | ±200ppb | -40 to 85°C | ( <a href="http://www.conwin.com/datasheets/tx/tx350.pdf">http://www.conwin.com/datasheets/tx/tx350.pdf</a> ) |
| -T2: T100F: | ±100ppb | 0 to 70°C   | ( <a href="http://www.conwin.com/datasheets/tx/tx350.pdf">http://www.conwin.com/datasheets/tx/tx350.pdf</a> ) |
| -T3: TL602: | ±100ppb | -20 to 70°C | ( <a href="http://www.conwin.com/datasheets/tx/tx414.pdf">http://www.conwin.com/datasheets/tx/tx414.pdf</a> ) |
| -T4: T602:  | ±280ppb | -40 to 85°C | ( <a href="http://www.conwin.com/datasheets/tx/tx176.pdf">http://www.conwin.com/datasheets/tx/tx176.pdf</a> ) |
| -T5: T612:  | ±0.5ppm | -40 to 85°C | ( <a href="http://www.conwin.com/datasheets/tx/tx176.pdf">http://www.conwin.com/datasheets/tx/tx176.pdf</a> ) |

OCXO Holdover Specification Options based on a choice of OCXO model number used on module Thermal Stability Options

(external 10MHz reference not available with DOCSC model choice):

|                 |        |             |   |
|-----------------|--------|-------------|---|
| -O1: DOCSC012F: | ±10ppb | -40 to 85°C | ( <a href="http://www.conwin.com/datasheets/cx/cx270.pdf">http://www.conwin.com/datasheets/cx/cx270.pdf</a> ) |
| -O2: DOCSC022F: | ±20ppb | -40 to 85°C | ( <a href="http://www.conwin.com/datasheets/cx/cx270.pdf">http://www.conwin.com/datasheets/cx/cx270.pdf</a> ) |
| -O3: DOCAT052F: | ±50ppb | -40 to 85°C | ( <a href="http://www.conwin.com/datasheets/cx/cx275.pdf">http://www.conwin.com/datasheets/cx/cx275.pdf</a> ) |

| Revision | Date     | Note  |
|----------|----------|---|
| P00      | 01/19/10 | Preliminary Release   |
| 00       | 06/14/10 | 125 Series Update and revised to release                              |
| 01       | 05/27/11 | Updated Block Diagram with Wi125 Receiver & Soldering Recommendations |
| 02       | 01/03/12 | Added Package & Physical Dimensions Information to Features           |
| 03       | 05/07/13 | Storage Temp/Absolute Max Rating updated                              |
| 04       | 07/02/19 | Updated Specifications & Model Number change                          |