

National Semiconductor is now part of
Texas Instruments.

Search <http://www.ti.com/> for the latest technical
information and details on our current products and services.

ADC121S705

12-Bit, 500 kSPS to 1 MSPS, Differential Input, Micro Power A/D Converter

General Description

The ADC121S705 is a 12-bit, 500 kSPS to 1 MSPS sampling Analog-to-Digital (A/D) converter that features a fully differential, high impedance analog input and an external reference. The reference voltage can be varied from 1.0V to V_A , with a corresponding resolution between 244 μ V and V_A divided by 4096.

The output serial data is binary 2's complement and is compatible with several standards, such as SPI™, QSPI™, MICROWIRE™, and many common DSP serial interfaces. The differential input, low power consumption, and small size make the ADC121S705 ideal for direct connection to transducers in battery operated systems or remote data acquisition applications.

Operating from a single 5V supply, the supply current when operating at 1 MSPS is typically 2.3 mA. The supply current drops down to 0.3 μ A typically when the ADC121S705 enters power-down mode. The ADC121S705 is available in the MSOP-8 package. Operation is guaranteed over the industrial temperature range of -40°C to $+105^{\circ}\text{C}$ and clock rates of 8 MHz to 16 MHz.

Features

- True Differential Inputs
- Guaranteed performance from 500 kSPS to 1 MSPS
- External Reference
- Wide Input Common-Mode Voltage Range
- SPI™/QSPI™/MICROWIRE™/DSP compatible Serial Interface

Key Specifications

■ Conversion Rate	500 kSPS to 1 MSPS
■ INL	± 0.95 LSB (max)
■ DNL	± 0.95 LSB (max)
■ Offset Error	± 3.0 LSB (max)
■ Gain Error	± 6.5 LSB (max)
■ SINAD	69.5 dB (min)
■ Power Consumption at $V_A = 5\text{V}$	
■ — Active, 1 MSPS	11.5 mW (typ)
■ — Active, 500 kSPS	9.0 mW (typ)
■ — Power-Down	1.5 μ W (typ)

Applications

- Automotive Navigation
- Portable Systems
- Medical Instruments
- Instrumentation and Control Systems
- Motor Control
- Direct Sensor Interface

Connection Diagram

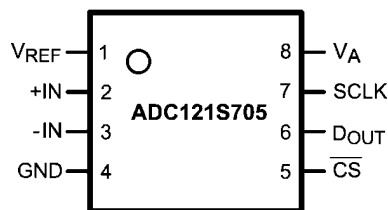

20186705

Ordering Information

Order Code	Temperature Range	Description	Top Mark
ADC121S705C1MM	-40°C to $+105^{\circ}\text{C}$	8-Lead MSOP Package, 1000 Units Tape & Reel	X1AC
ADC121S705C1MMX	-40°C to $+105^{\circ}\text{C}$	8-Lead MSOP Package, 3500 Units Tape & Reel	X1AC
ADC121S705EB		Evaluation Board	

TRI-STATE® is a trademark of National Semiconductor Corporation.
 MICROWIRE™ is a trademark of National Semiconductor Corporation.
 QSPI™ and SPI™ are trademarks of Motorola, Inc.

Block Diagram

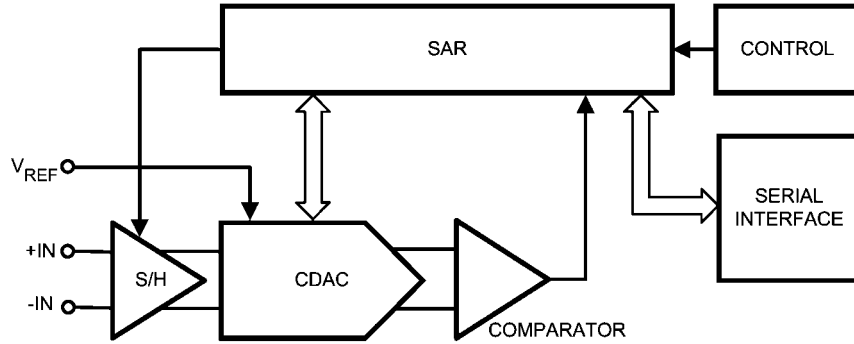

20186702

Pin Descriptions and Equivalent Circuits

Pin No.	Symbol	Description
1	V_{REF}	Voltage Reference Input. A voltage reference between 1V and V_A must be applied to this input. V_{REF} must be decoupled to GND with a minimum ceramic capacitor value of 0.1 μ F. A bulk capacitor value of 1.0 μ F to 10 μ F in parallel with the 0.1 μ F is recommended for enhanced performance.
2	+IN	Non-Inverting Input. +IN is the positive analog input for the differential signal applied to the ADC121S705.
3	-IN	Inverting Input. -IN is the negative analog input for the differential signal applied to the ADC121S705.
4	GND	Ground. GND is the ground reference point for all signals applied to the ADC121S705.
5	\overline{CS}	Chip Select Bar. \overline{CS} is active low. The ADC121S705 is in Normal Mode when \overline{CS} is LOW and Power-Down Mode when \overline{CS} is HIGH. A conversion begins on the fall of \overline{CS} .
6	D_{OUT}	Serial Data Output. The conversion result is provided on D_{OUT} . The serial data output word is comprised of 4 null bits and 12 data bits (MSB first). During a conversion, the data is outputted on the falling edges of SCLK and is valid on the rising edges.
7	SCLK	Serial Clock. SCLK is used to control data transfer and serves as the conversion clock.
8	V_A	Power Supply input. A voltage source between 4.5V and 5.5V must be applied to this input. V_A must be decoupled to GND with a ceramic capacitor value of 0.1 μ F in parallel with a bulk capacitor value of 1.0 μ F to 10 μ F.

Absolute Maximum Ratings (Notes 1, 2)

If Military/Aerospace specified devices are required, please contact the National Semiconductor Sales Office/Distributors for availability and specifications.

Analog Supply Voltage V_A	-0.3V to 6.5V
Voltage on Any Pin to GND	-0.3V to ($V_A + 0.3V$)
Input Current at Any Pin (Note 3)	± 10 mA
Package Input Current (Note 3)	± 50 mA
Power Consumption at $T_A = 25^\circ\text{C}$	See (Note 4)
ESD Susceptibility (Note 5)	
Human Body Model	2500V
Machine Model	250V
Charge Device Model	750V
Junction Temperature	$+150^\circ\text{C}$
Storage Temperature	-65°C to $+150^\circ\text{C}$

Operating Ratings (Notes 1, 2)

Operating Temperature Range	$-40^\circ\text{C} \leq T_A \leq +105^\circ\text{C}$
Supply Voltage, V_A	+4.5V to +5.5V
Reference Voltage, V_{REF}	1.0V to V_A
Input Common-Mode Voltage, V_{CM}	See Figure 8 (Sect 2.3)
Digital Input Pins Voltage Range	0 to V_A
Clock Frequency	8 MHz to 16 MHz
Differential Analog Input Voltage	$-V_{REF}$ to $+V_{REF}$

Package Thermal Resistance

Package	θ_{JA}
8-lead MSOP	$200^\circ\text{C} / \text{W}$

Soldering process must comply with National Semiconductor's Reflow Temperature Profile specifications. Refer to www.national.com/packaging. (Note 6)

ADC121S705 Converter Electrical Characteristics (Note 8)

The following specifications apply for $V_A = +4.5V$ to $5.5V$, $V_{REF} = 2.5V$, $f_{SCLK} = 8$ to 16 MHz, $f_{IN} = 100$ kHz, $C_L = 25$ pF, unless otherwise noted. **Boldface limits apply for $T_A = T_{MIN}$ to T_{MAX}** ; all other limits are at $T_A = 25^\circ\text{C}$.

Symbol	Parameter	Conditions	Typical	Limits	Units (Note 7)
STATIC CONVERTER CHARACTERISTICS					
	Resolution with No Missing Codes			12	Bits
INL	Integral Non-Linearity		± 0.6	± 0.95	LSB (max)
DNL	Differential Non-Linearity		± 0.4	± 0.95	LSB (max)
OE	Offset Error		-0.4	± 3	LSB (max)
FSE	Positive Full-Scale Error		+0.1	± 2	LSB (max)
	Negative Full-Scale Error		-1.0	± 6	LSB (max)
GE	Gain Error		+1.0	± 6.5	LSB (max)
DYNAMIC CONVERTER CHARACTERISTICS					
SINAD	Signal-to-Noise Plus Distortion Ratio	$f_{IN} = 100$ kHz, -0.1 dBFS	72.2	69.5	dBc (min)
SNR	Signal-to-Noise Ratio	$f_{IN} = 100$ kHz, -0.1 dBFS	72.8	71	dBc (min)
THD	Total Harmonic Distortion	$f_{IN} = 100$ kHz, -0.1 dBFS	-81.6	-72	dBc (max)
SFDR	Spurious-Free Dynamic Range	$f_{IN} = 100$ kHz, -0.1 dBFS	83.9	72	dBc (min)
ENOB	Effective Number of Bits	$f_{IN} = 100$ kHz, -0.1 dBFS	11.7	11.25	bits (min)
FPBW	-3 dB Full Power Bandwidth	Output at 70.7%FS with FS Input	Differential Input	26	MHz
			Single-Ended Input	22	MHz
ANALOG INPUT CHARACTERISTICS					
V_{IN}	Differential Input Range			$-V_{REF}$	V (min)
				$+V_{REF}$	V (max)
I_{DCL}	DC Leakage Current	$V_{IN} = V_{REF}$ or $V_{IN} = -V_{REF}$		± 1	μA (max)
C_{INA}	Input Capacitance	In Track Mode	17		pF
		In Hold Mode	3		pF
CMRR	Common Mode Rejection Ratio	See the Specification Definitions for the test condition	76		dB
V_{REF}	Reference Voltage Range			1.0	V (min)
				V_A	V (max)

Symbol	Parameter	Conditions	Typical	Limits	Units (Note 7)
I_{REF}	Reference Current	\overline{CS} low, $f_{SCLK} = 16$ MHz, $f_S = 1$ MSPS, output = FF8h	55		μA
		\overline{CS} low, $f_{SCLK} = 8$ MHz, $f_S = 500$ kSPS, output = FF8h	28		μA
		\overline{CS} high, $f_{SCLK} = 0$	0.2		μA
DIGITAL INPUT CHARACTERISTICS					
V_{IH}	Input High Voltage		2.6	3.6	V (min)
V_{IL}	Input Low Voltage		2.5	1.5	V (max)
I_{IN}	Input Current	$V_{IN} = 0V$ or V_A		± 1	μA (max)
C_{IND}	Input Capacitance		2	4	pF (max)
DIGITAL OUTPUT CHARACTERISTICS					
V_{OH}	Output High Voltage	$I_{SOURCE} = 200 \mu A$	$V_A - 0.12$	$V_A - 0.2$	V (min)
		$I_{SOURCE} = 1$ mA	$V_A - 0.16$		V
V_{OL}	Output Low Voltage	$I_{SINK} = 200 \mu A$	0.01	0.4	V (max)
		$I_{SINK} = 1$ mA	0.05		V
I_{OZH}, I_{OZL}	TRI-STATE Leakage Current	Force 0V or V_A		± 1	μA (max)
C_{OUT}	TRI-STATE Output Capacitance	Force 0V or V_A	2	4	pF (max)
	Output Coding		Binary 2'S Complement		
POWER SUPPLY CHARACTERISTICS					
V_A	Analog Supply Voltage			4.5	V (min)
				5.5	V (max)
I_{VA} (Normal))	Supply Current, Normal Mode (Operational)	$f_{SCLK} = 16$ MHz, $f_S = 1$ MSPS, $f_{IN} = 100$ kHz	2.3	3	mA (max)
		$f_{SCLK} = 8$ MHz, $f_S = 500$ kSPS, $f_{IN} = 100$ kHz	1.8		mA
I_{VA} (PD)	Supply Current, Power Down Mode (\overline{CS} high)	$f_{SCLK} = 16$ MHz	56		μA (max)
		$f_{SCLK} = 0$ (Note 8)	0.3	2	μA (max)
PWR (Normal))	Power Consumption, Normal Mode (Operational)	$f_{SCLK} = 16$ MHz, $f_S = 1$ MSPS, $f_{IN} = 100$ kHz, $V_A = 5.0V$	11.5		mW
		$f_{SCLK} = 8$ MHz, $f_S = 500$ kSPS, $f_{IN} = 100$ kHz, $V_A = 5.0V$	9.0		mW
PWR (PD)	Power Consumption, Power Down Mode (\overline{CS} high)	$f_{SCLK} = 16$ MHz, $V_A = 5.0V$	280		μW
		$f_{SCLK} = 0$, $V_A = 5.0V$	1.5		μW
PSRR	Power Supply Rejection Ratio	See the Specification Definitions for the test condition	-85		dB
AC ELECTRICAL CHARACTERISTICS					
f_{SCLK}	Maximum Clock Frequency		20	16	MHz (min)
f_{SCLK}	Minimum Clock Frequency		0.8	8	MHz (max)
f_S	Maximum Sample Rate		1.25	1	MSPS (min)
t_{ACQ}	Track/Hold Acquisition Time			2.5	SCLK cycles (min)
				3.0	SCLK cycles (max)
t_{CONV}	Conversion Time			13	SCLK cycles
t_{AD}	Aperture Delay	See the Specification Definitions	6		ns

ADC121S705 Timing Specifications (Note 8)

The following specifications apply for $V_A = +4.5V$ to $5.5V$, $V_{REF} = 2.5V$, $f_{SCLK} = 8$ MHz to 16 MHz, $C_L = 25$ pF, **Boldface limits apply for $T_A = T_{MIN}$ to T_{MAX}** ; all other limits $T_A = 25^\circ C$.

Symbol	Parameter	Conditions	Typical	Limits	Units
t_{CSH}	\overline{CS} Hold Time after an SCLK rising edge			5	ns (min)
t_{CSSU}	\overline{CS} Setup Time prior to an SCLK rising edge			5	ns (min)
t_{DH}	D_{OUT} Hold time after an SCLK Falling edge		7	2.5	ns (min)
t_{DA}	D_{OUT} Access time after an SCLK Falling edge		18	22	ns (max)
t_{DIS}	D_{OUT} Disable Time after the rising edge of \overline{CS} (Note 10)			20	ns (max)
t_{EN}	D_{OUT} Enable Time after the falling edge of \overline{CS}		8	20	ns (max)
t_{CH}	SCLK High Time			25	ns (min)
t_{CL}	SCLK Low Time			25	ns (min)
t_r	D_{OUT} Rise Time		7		ns
t_f	D_{OUT} Fall Time		7		ns

Note 1: Absolute Maximum Ratings indicate limits beyond which damage to the device may occur. Operating Ratings indicate conditions for which the device is functional, but do not guarantee specific performance limits. For guaranteed specifications and test conditions, see the Electrical Characteristics. The guaranteed specifications apply only for the test conditions listed. Some performance characteristics may degrade when the device is not operated under the listed test conditions. Operation of the device beyond the maximum Operating Ratings is not recommended.

Note 2: All voltages are measured with respect to GND = 0V, unless otherwise specified.

Note 3: When the input voltage at any pin exceeds the power supplies (that is, $V_{IN} < GND$ or $V_{IN} > V_A$), the current at that pin should be limited to 10 mA. The 50 mA maximum package input current rating limits the number of pins that can safely exceed the power supplies with an input current of 10 mA to five.

Note 4: The absolute maximum junction temperature ($T_{J,max}$) for this device is $150^\circ C$. The maximum allowable power dissipation is dictated by $T_{J,max}$, the junction-to-ambient thermal resistance (θ_{JA}), and the ambient temperature (T_A), and can be calculated using the formula $P_{D,MAX} = (T_{J,max} - T_A)/\theta_{JA}$. The values for maximum power dissipation listed above will be reached only when the ADC121S705 is operated in a severe fault condition (e.g. when input or output pins are driven beyond the power supply voltages, or the power supply polarity is reversed). Such conditions should always be avoided.

Note 5: Human body model is a 100 pF capacitor discharged through a 1.5 k Ω resistor. Machine model is a 220 pF capacitor discharged through 0 Ω . Charge device model simulates a pin slowly acquiring charge (such as from a device sliding down the feeder in an automated assembler) then rapidly being discharged.

Note 6: Reflow temperature profiles are different for lead-free packages.

Note 7: Tested limits are guaranteed to National's AOQL (Average Outgoing Quality Level).

Note 8: Data sheet min/max specification limits are guaranteed by design, test, or statistical analysis.

Note 9: While the maximum sample rate is $f_{SCLK}/16$, the actual sample rate may be lower than this by having the \overline{CS} rate slower than $f_{SCLK}/16$.

Note 10: t_{DIS} is the time for D_{OUT} to change 10% while being loaded by the Timing Test Circuit.

Timing Diagrams

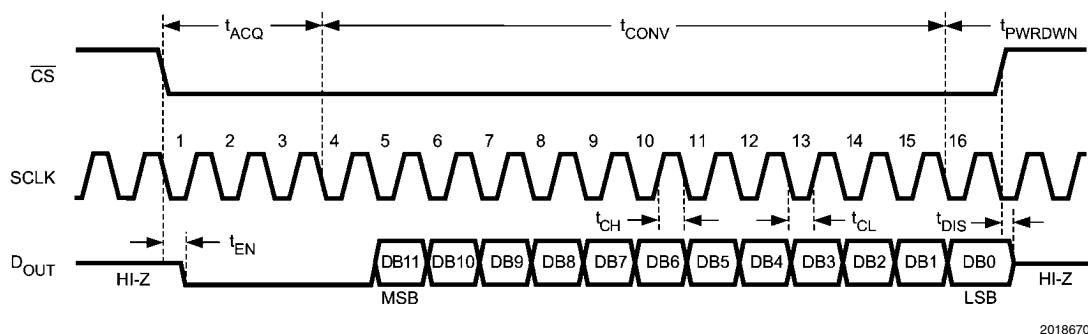
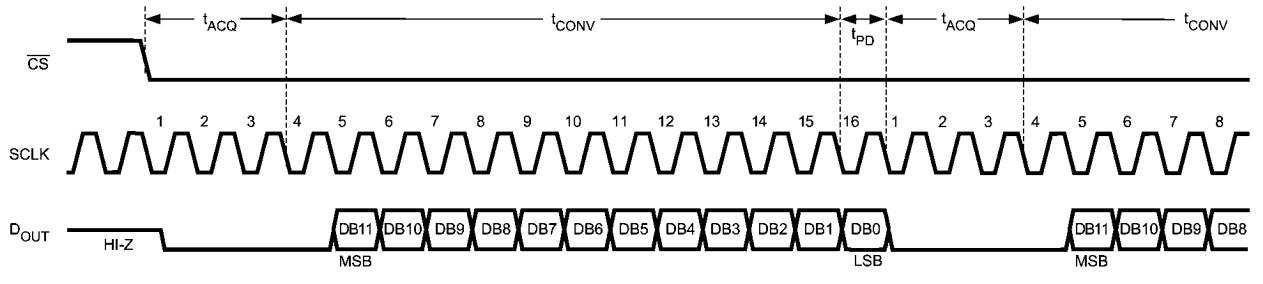
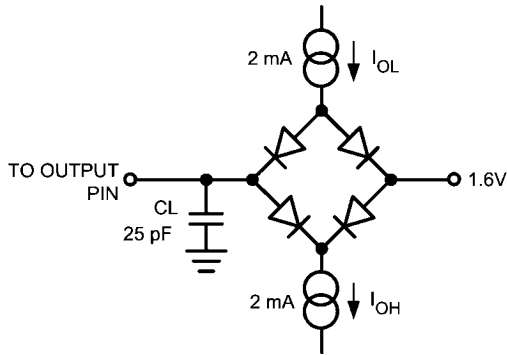

FIGURE 1. ADC121S705 Single Conversion Timing Diagram



20186704

FIGURE 2. ADC121S705 Continuous Conversion Timing Diagram



20186708

FIGURE 3. Timing Test Circuit

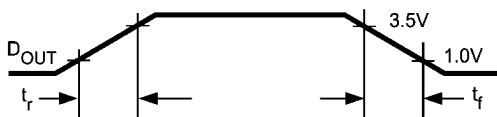

20186706

FIGURE 4. D_{OUT} Rise and Fall Times

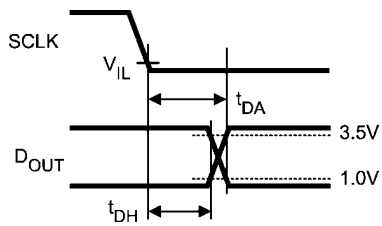

20186711

FIGURE 5. D_{OUT} Hold and Access Times

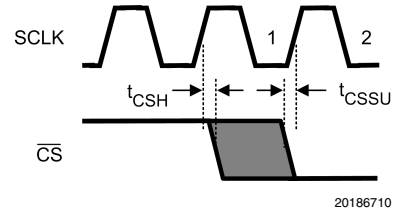

20186710

FIGURE 6. Valid \overline{CS} Assertion Times

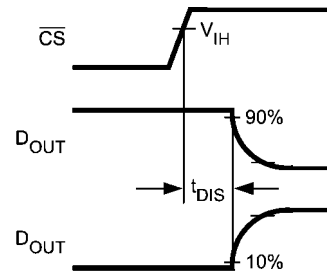

20186712

FIGURE 7. Voltage Waveform for t_{DIS}

Specification Definitions

APERTURE DELAY is the time between the fourth falling edge of SCLK and the time when the input signal is acquired or held for conversion.

COMMON MODE REJECTION RATIO (CMRR) is a measure of how well in-phase signals common to both input pins are rejected.

To calculate CMRR, the change in output offset is measured while the common mode input voltage is changed from 2V to 3V.

$$\text{CMRR} = 20 \text{ LOG} (\Delta \text{ Common Input} / \Delta \text{ Output Offset})$$

CONVERSION TIME is the time required, after the input voltage is acquired, for the ADC to convert the input voltage to a digital word.

DIFFERENTIAL NON-LINEARITY (DNL) is the measure of the maximum deviation from the ideal step size of 1 LSB.

DUTY CYCLE is the ratio of the time that a repetitive digital waveform is high to the total time of one period. The specification here refers to the SCLK.

EFFECTIVE NUMBER OF BITS (ENOB, or EFFECTIVE BITS) is another method of specifying Signal-to-Noise and Distortion or SINAD. ENOB is defined as $(\text{SINAD} - 1.76) / 6.02$ and says that the converter is equivalent to a perfect ADC of this (ENOB) number of bits.

FULL POWER BANDWIDTH is a measure of the frequency at which the reconstructed output fundamental drops 3 dB below its low frequency value for a full scale input.

GAIN ERROR is the deviation from the ideal slope of the transfer function. It is the difference between Positive Full-Scale Error and Negative Full-Scale Error and can be calculated as:

$$\text{Gain Error} = \text{Positive Full-Scale Error} - \text{Negative Full-Scale Error}$$

INTEGRAL NON-LINEARITY (INL) is a measure of the deviation of each individual code from a line drawn from negative full scale ($\frac{1}{2}$ LSB below the first code transition) through positive full scale ($\frac{1}{2}$ LSB above the last code transition). The deviation of any given code from this straight line is measured from the center of that code value.

MISSING CODES are those output codes that will never appear at the ADC outputs. The ADC121S705 is guaranteed not to have any missing codes.

NEGATIVE FULL-SCALE ERROR is the difference between the differential input voltage at which the output code transi-

tions from negative full scale to the next code and $-V_{\text{REF}} + 0.5$ LSB

OFFSET ERROR is the difference between the differential input voltage at which the output code transitions from code 000h to 001h and $1/2$ LSB.

POSITIVE FULL-SCALE ERROR is the difference between the differential input voltage at which the output code transitions to positive full scale and V_{REF} minus 1.5 LSB.

POWER SUPPLY REJECTION RATIO (PSRR) is a measure of how well a change in supply voltage is rejected. PSRR is calculated from the ratio of the change in offset error for a given change in supply voltage, expressed in dB. For the ADC121S705, V_A is changed from 4.5V to 5.5V.

$$\text{PSRR} = 20 \text{ LOG} (\Delta \text{Offset} / \Delta V_A)$$

SIGNAL TO NOISE RATIO (SNR) is the ratio, expressed in dB, of the rms value of the input signal to the rms value of the sum of all other spectral components below one-half the sampling frequency, not including harmonics or d.c.

SIGNAL TO NOISE PLUS DISTORTION (S/N+D or SINAD) is the ratio, expressed in dB, of the rms value of the input signal to the rms value of all of the other spectral components below half the clock frequency, including harmonics but excluding d.c.

SPURIOUS FREE DYNAMIC RANGE (SFDR) is the difference, expressed in dB, between the desired signal amplitude to the amplitude of the peak spurious spectral component, where a spurious spectral component is any signal present in the output spectrum that is not present at the input and may or may not be a harmonic.

TOTAL HARMONIC DISTORTION (THD) is the ratio of the rms total of the first five harmonic components at the output to the rms level of the input signal frequency as seen at the output, expressed in dB. THD is calculated as

$$\text{THD} = 20 \cdot \log_{10} \sqrt{\frac{A_{f2}^2 + \dots + A_{f6}^2}{A_{f1}^2}}$$

where A_{f1} is the RMS power of the input frequency at the output and A_{f2} through A_{f6} are the RMS power in the first 5 harmonic frequencies.

THROUGHPUT TIME is the minimum time required between the start of two successive conversion.

Typical Performance Characteristics $V_A = 5.0V, V_{REF} = 2.5V, T_A = +25^\circ C, f_{SAMPLE} = 1 \text{ MSPS}, f_{SCLK} = 16 \text{ MHz}, f_{IN} = 100 \text{ kHz}$ unless otherwise stated.

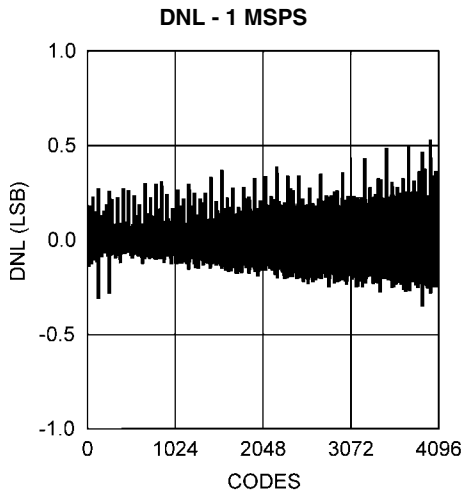

20186721

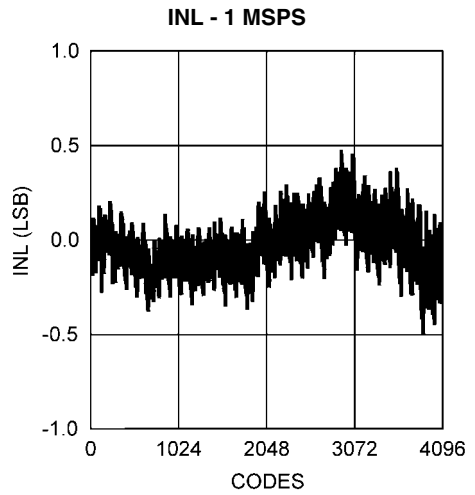

20186722

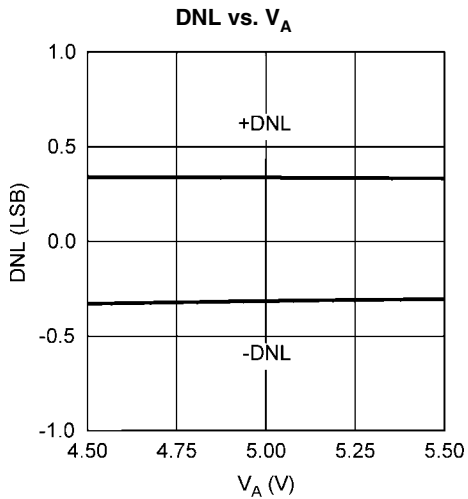

20186723

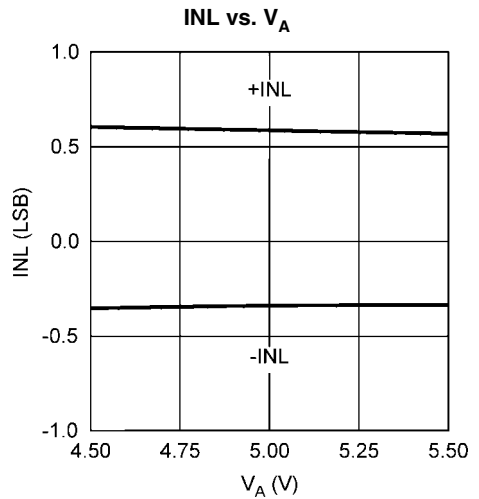

20186724

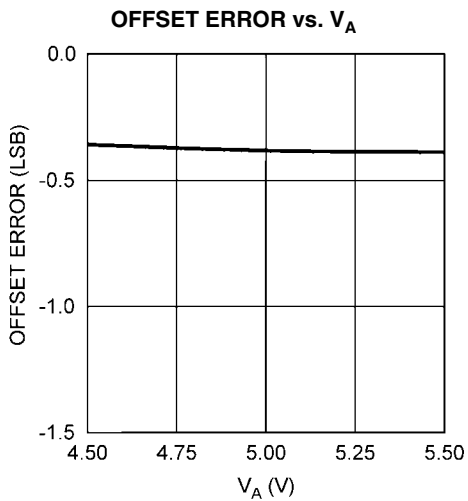

20186774

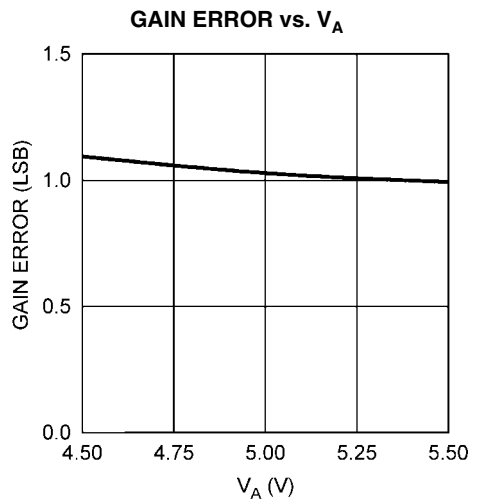

20186777

Typical Performance Characteristics $V_A = 5.0V$, $V_{REF} = 2.5V$, $T_A = +25^\circ C$, $f_{SAMPLE} = 1 \text{ MSPS}$, $f_{SCLK} = 16 \text{ MHz}$, $f_{IN} = 100 \text{ kHz}$ unless otherwise stated.

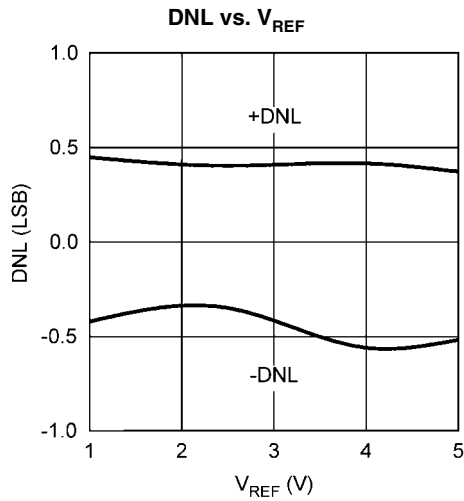

20186718

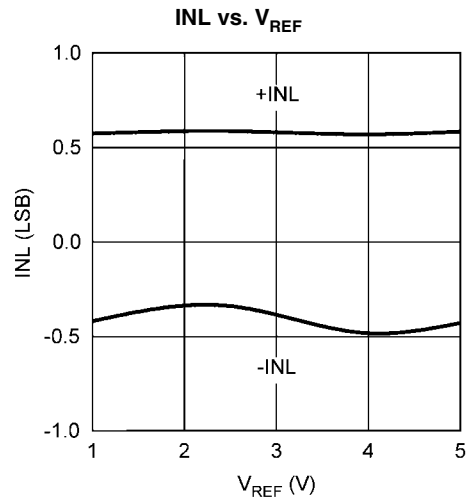

20186719

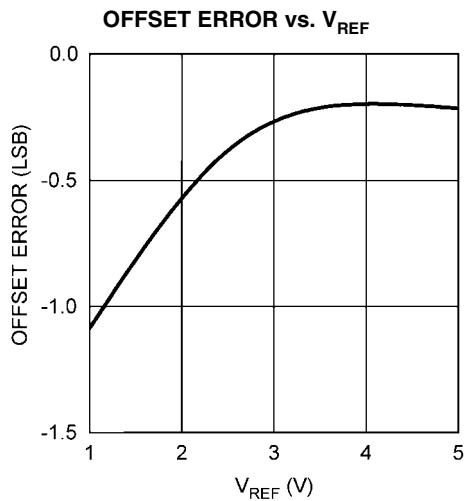

20186756

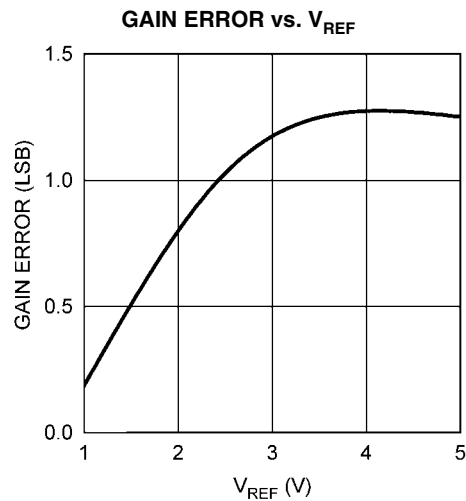

20186758

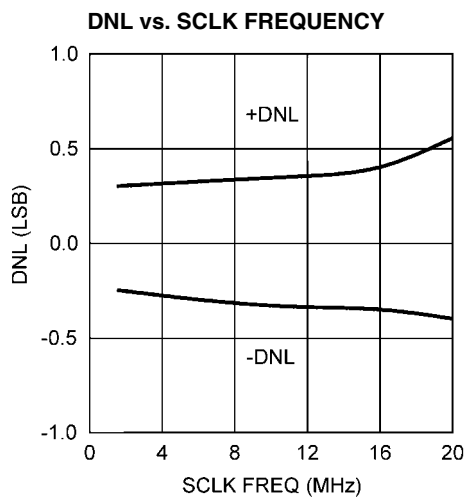

20186725

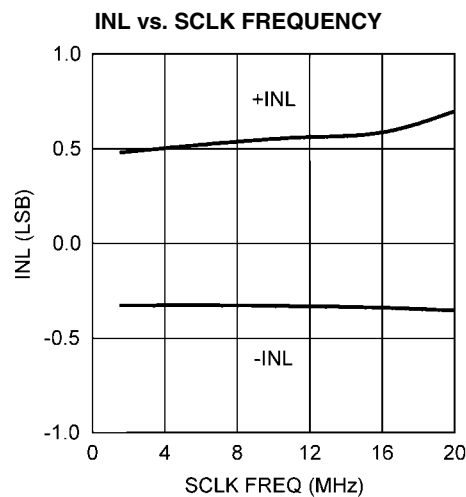

20186726

Typical Performance Characteristics

16 MHz, $f_{IN} = 100$ kHz unless otherwise stated.

$V_A = 5.0V$, $V_{REF} = 2.5V$, $T_A = +25^\circ C$, $f_{SAMPLE} = 1$ MSPS, $f_{SCLK} =$

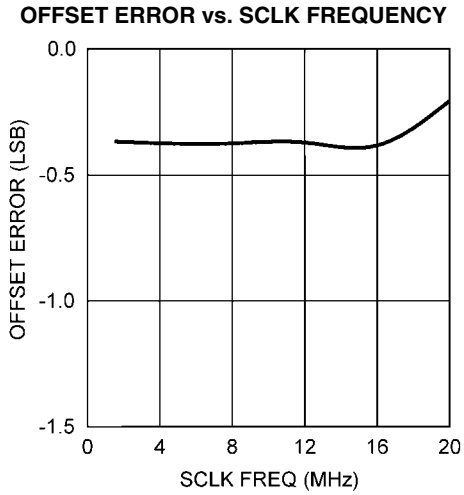

20186775

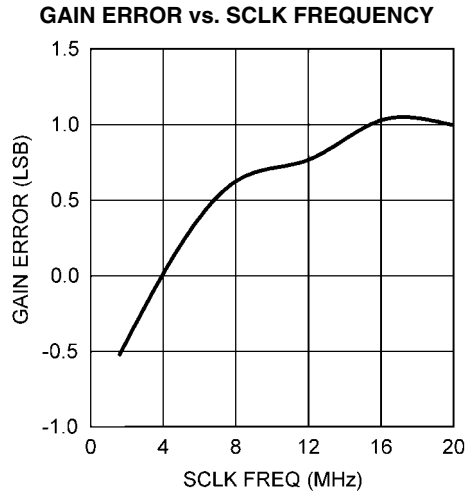

20186778

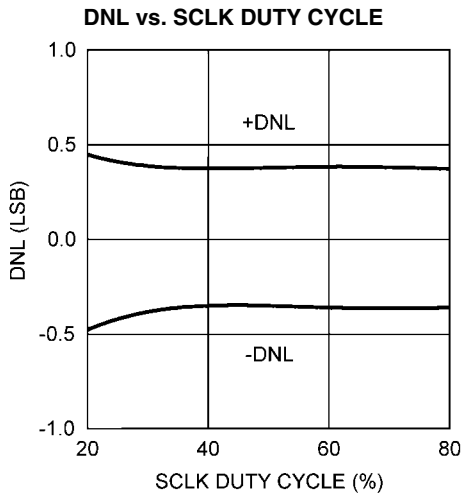

20186727

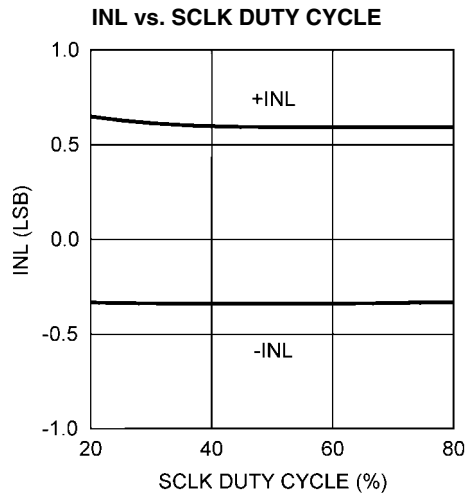

20186728

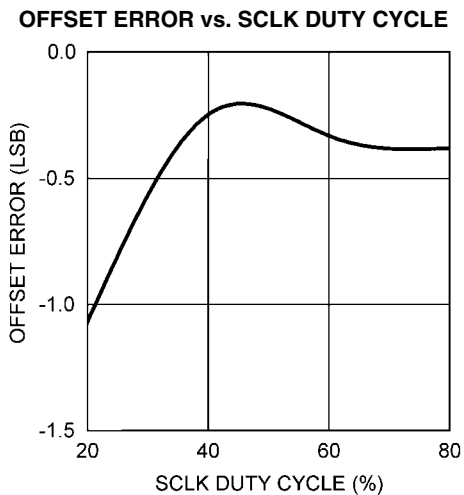

20186776

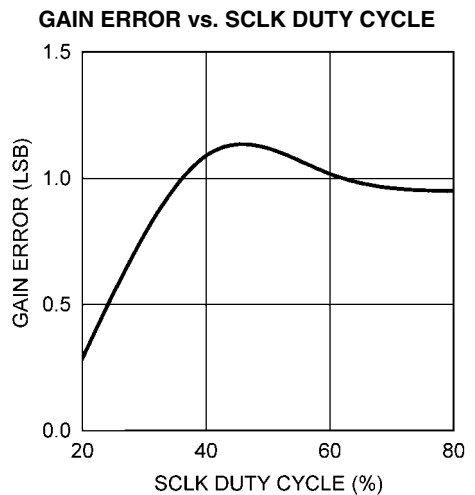

20186779

Typical Performance Characteristics $V_A = 5.0V, V_{REF} = 2.5V, T_A = +25^\circ C, f_{SAMPLE} = 1 \text{ MSPS}, f_{SCLK} = 16 \text{ MHz}, f_{IN} = 100 \text{ kHz}$ unless otherwise stated.

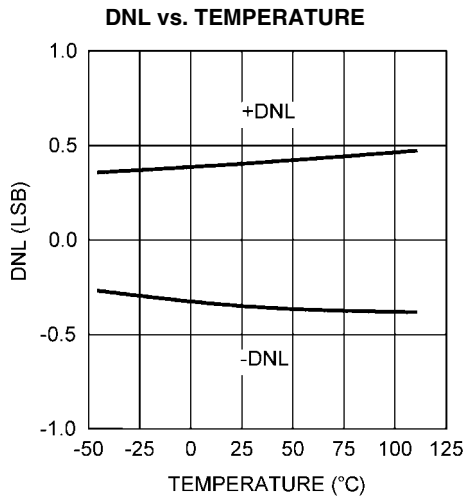

20186729

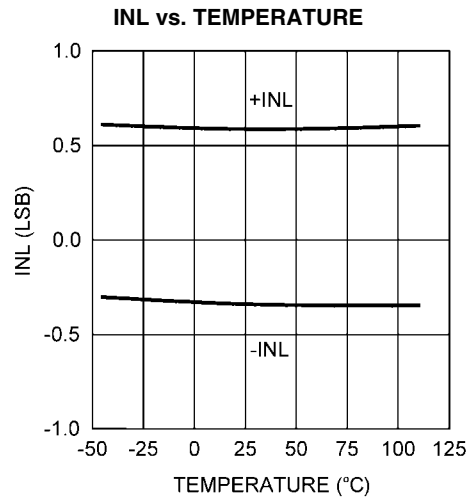

20186730

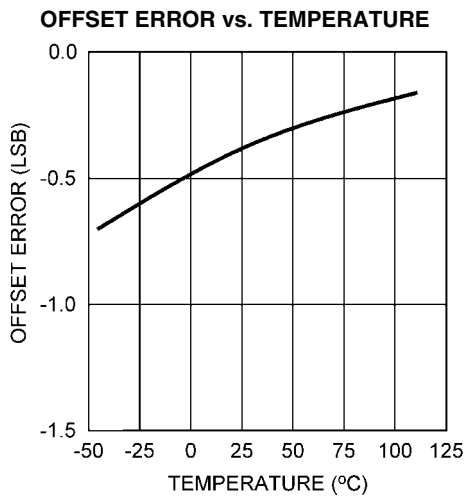

20186757

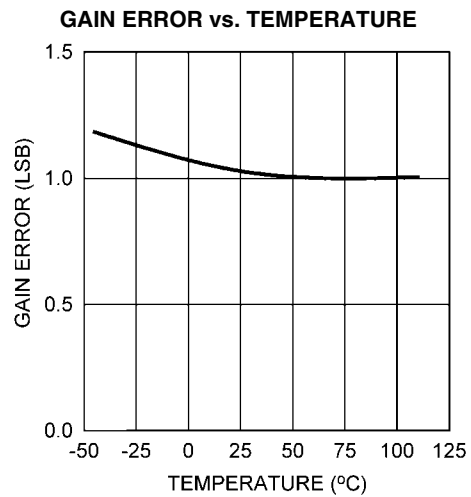

20186759

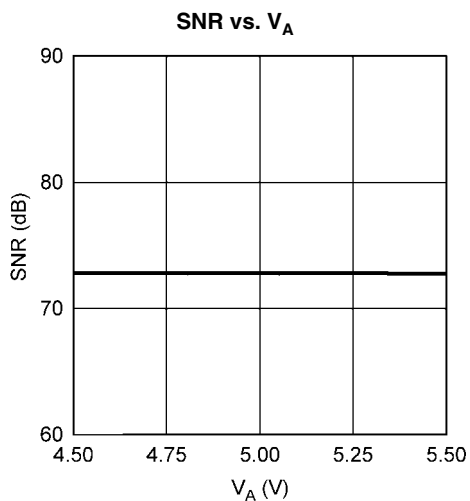

20186731

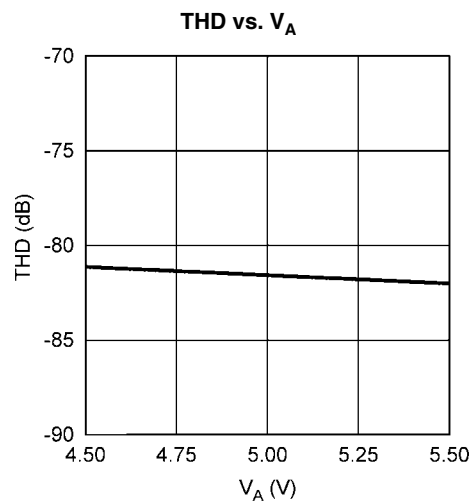

20186732

Typical Performance Characteristics $V_A = 5.0V, V_{REF} = 2.5V, T_A = +25^\circ C, f_{SAMPLE} = 1 \text{ MSPS}, f_{SCLK} = 16 \text{ MHz}, f_{IN} = 100 \text{ kHz}$ unless otherwise stated.

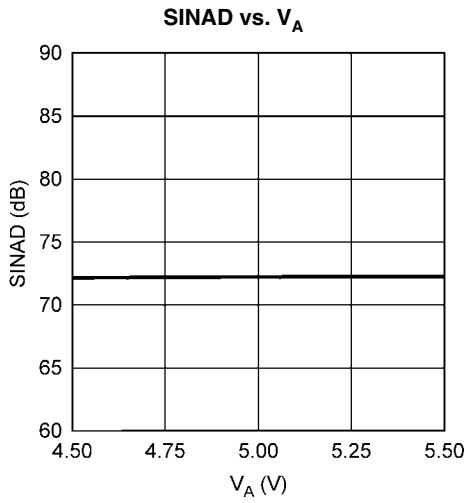

20186733

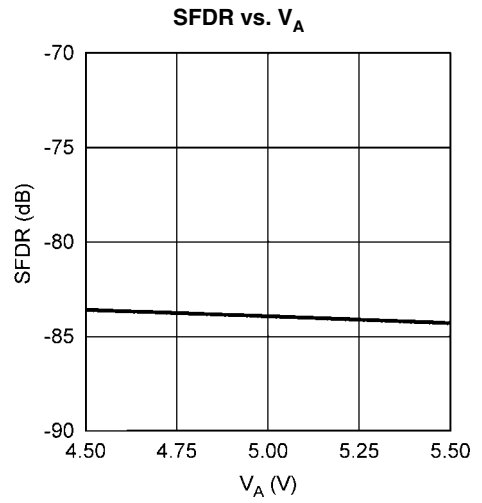

20186734

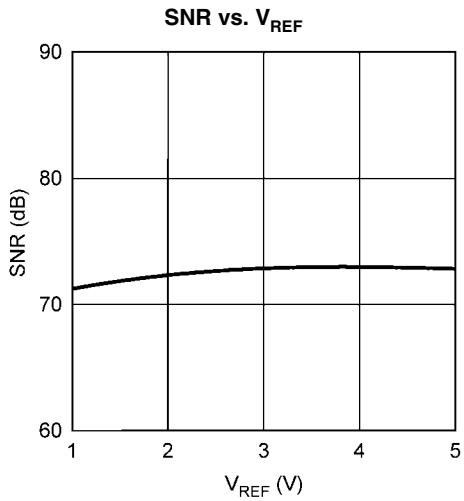

20186735

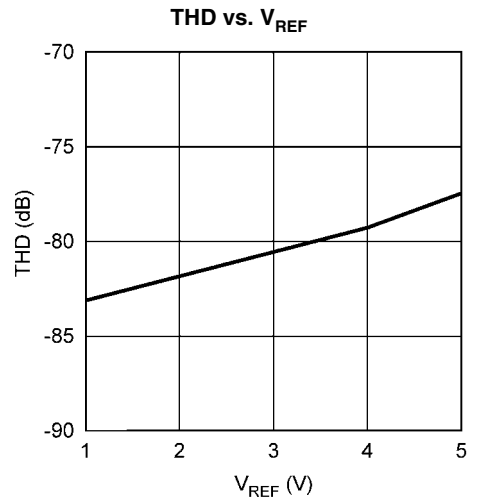

20186736

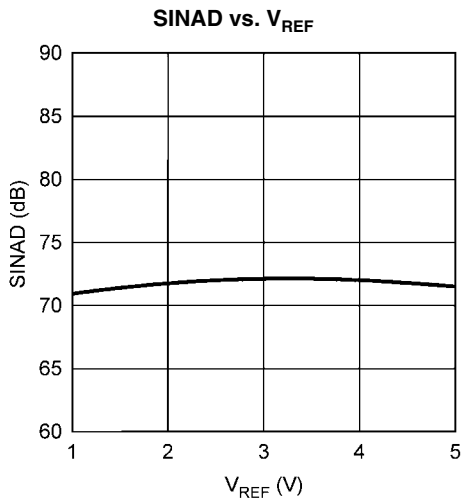

20186737

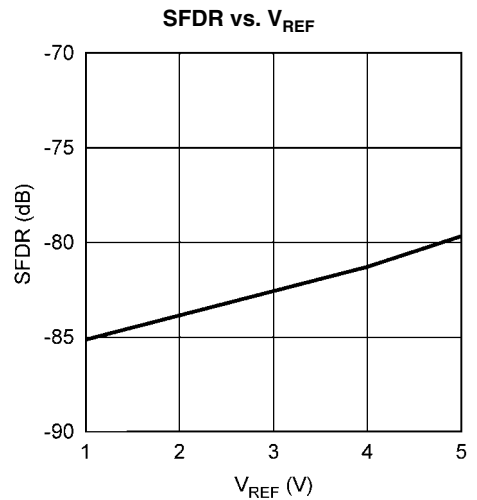

20186738

Typical Performance Characteristics $V_A = 5.0V, V_{REF} = 2.5V, T_A = +25^\circ C, f_{SAMPLE} = 1 \text{ MSPS}, f_{SCLK} = 16 \text{ MHz}, f_{IN} = 100 \text{ kHz}$ unless otherwise stated.

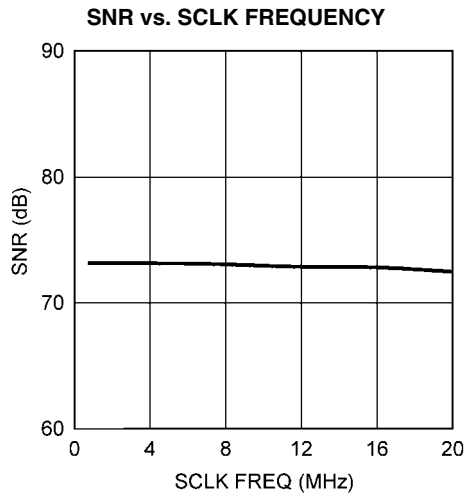

20186739

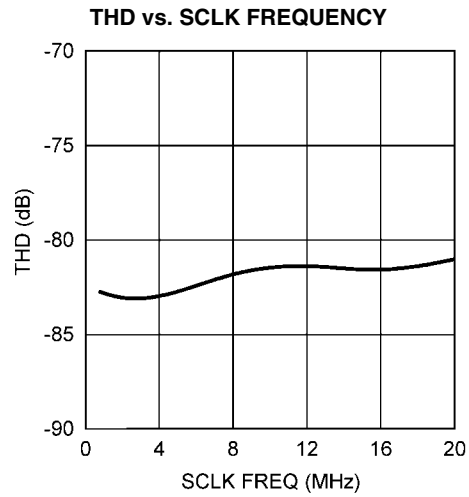

20186740

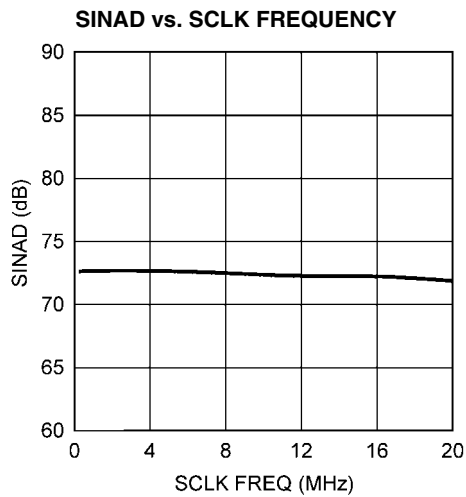

20186741

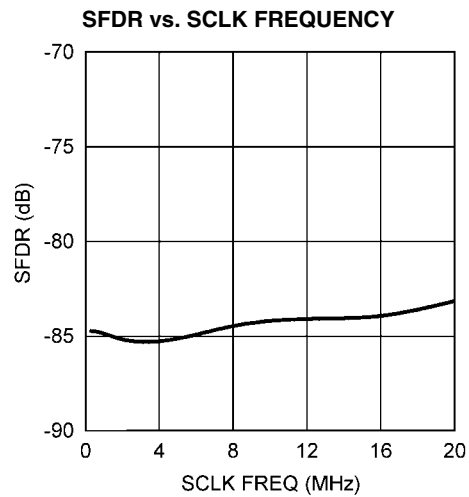

20186742

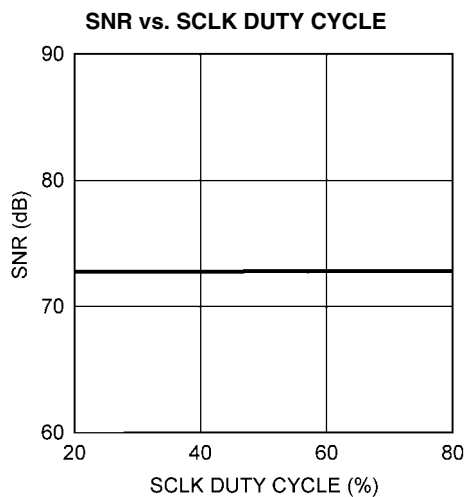

20186743

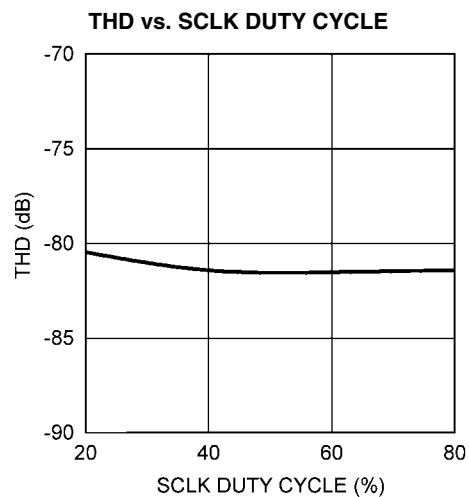

20186744

Typical Performance Characteristics $V_A = 5.0V$, $V_{REF} = 2.5V$, $T_A = +25^\circ C$, $f_{SAMPLE} = 1 \text{ MSPS}$, $f_{SCLK} = 16 \text{ MHz}$, $f_{IN} = 100 \text{ kHz}$ unless otherwise stated.

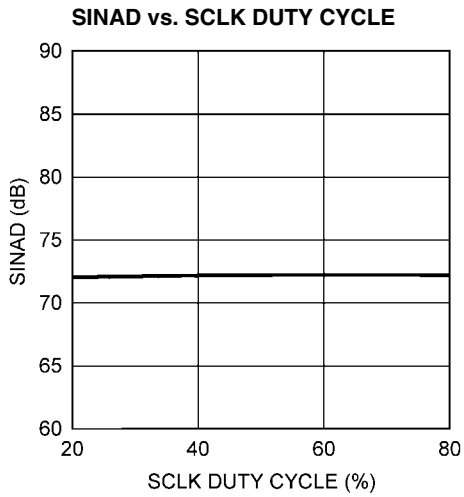

20186745

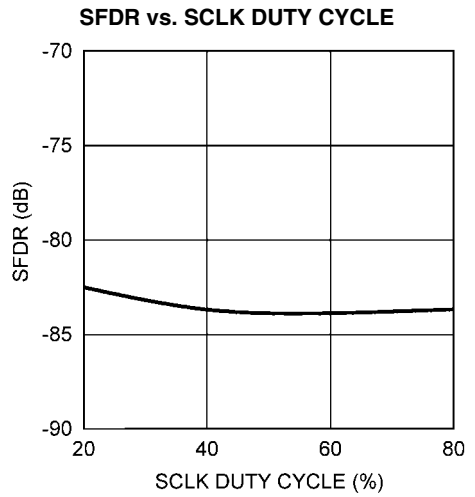

20186746

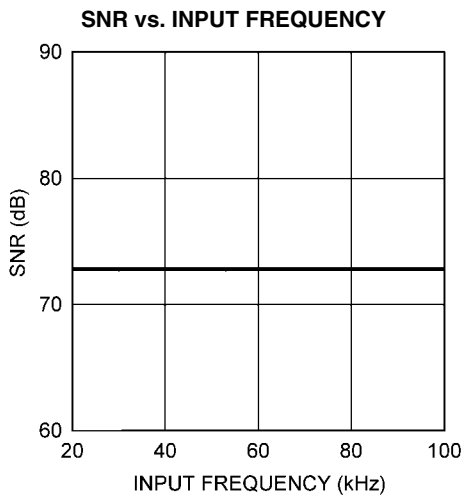

20186747

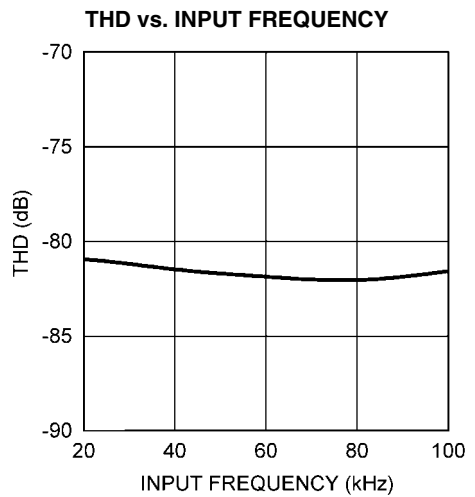

20186748

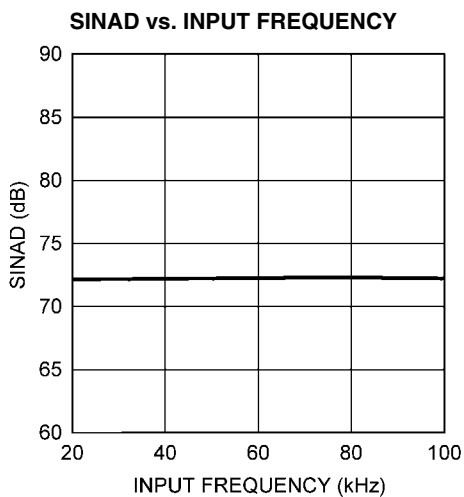

20186749

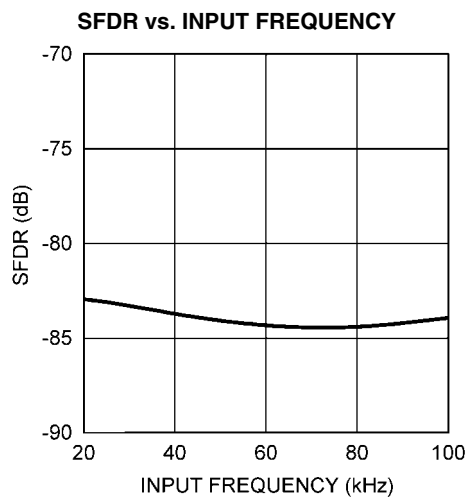

20186750

Typical Performance Characteristics $V_A = 5.0V, V_{REF} = 2.5V, T_A = +25^\circ C, f_{SAMPLE} = 1 \text{ MSPS}, f_{SCLK} = 16 \text{ MHz}, f_{IN} = 100 \text{ kHz}$ unless otherwise stated.

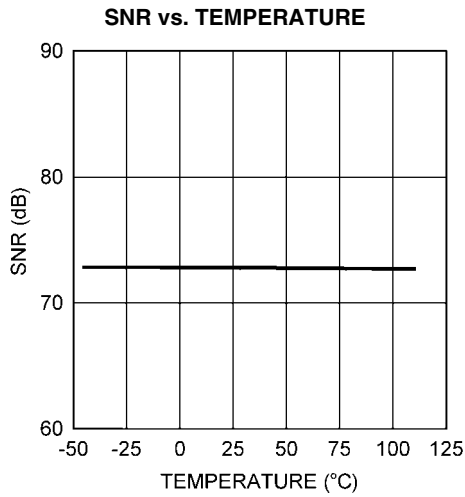

20186770

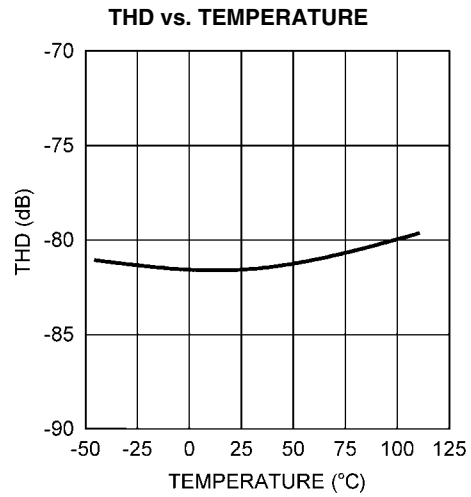

20186771

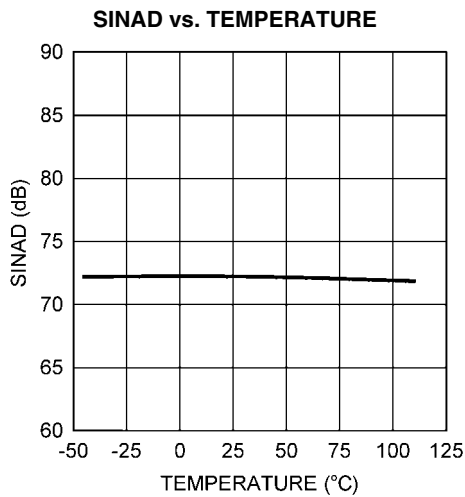

20186772

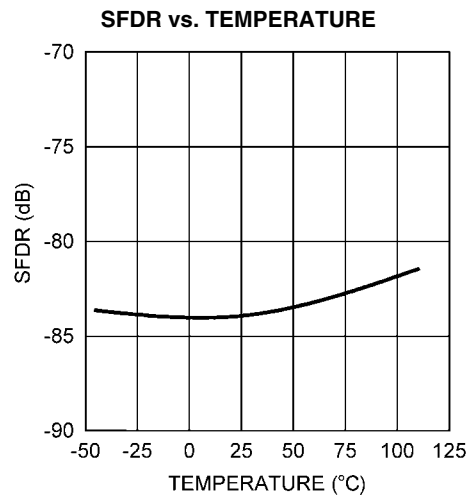

20186773

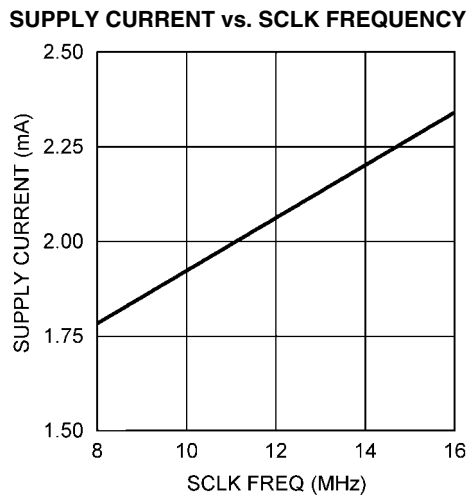

20186755

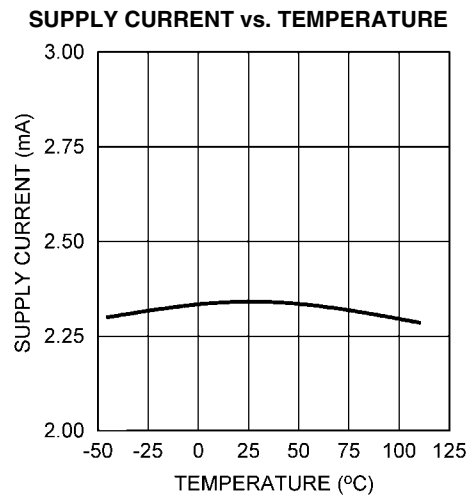

20186754

Typical Performance Characteristics $V_A = 5.0V, V_{REF} = 2.5V, T_A = +25^\circ C, f_{SAMPLE} = 1 \text{ MSPS}, f_{SCLK} = 16 \text{ MHz}, f_{IN} = 100 \text{ kHz}$ unless otherwise stated.

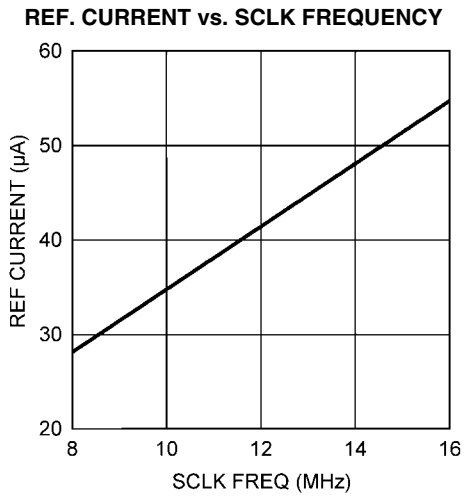

20186752

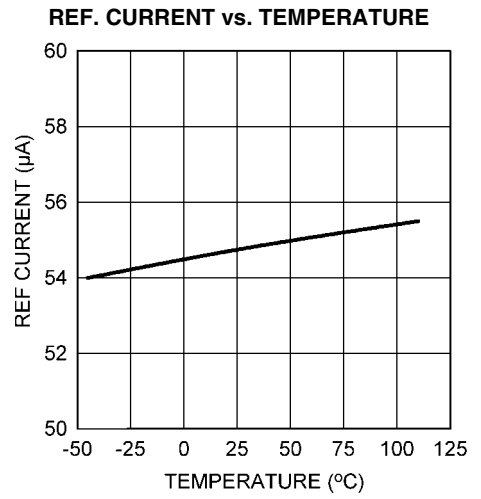

20186751

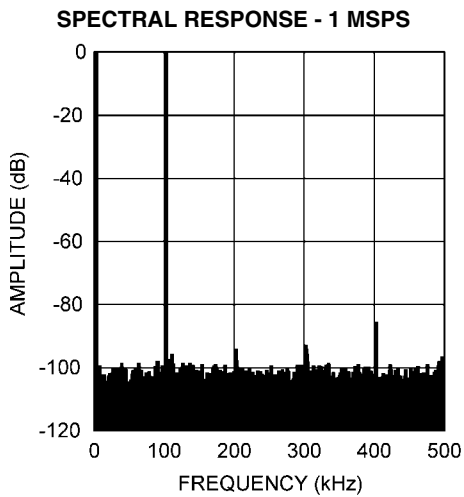

20186714

Functional Description

The ADC121S705 analog-to-digital converter uses a successive approximation register (SAR) architecture based upon capacitive redistribution containing an inherent sample/hold function. The architecture and process allow the ADC121S705 to acquire and convert an analog signal at sample rates up to 1 MSPS while consuming very little power.

The ADC121S705 requires an external reference, external clock, and a single +5V power source that can be as low as +4.5V. The external reference can be any voltage between 1V and V_A . The value of the reference voltage determines the range of the analog input, while the reference input current depends upon the conversion rate.

The external clock can take on values as indicated in the Electrical Characteristics Table of this data sheet. The duty cycle of the clock is essentially unimportant, provided the minimum clock high and low times are met. The minimum clock frequency is set by internal capacitor leakage. Each conversion requires 16 SCLK cycles to complete. If less than 12 bits of conversion data are required, \overline{CS} can be brought high at any point during the conversion. This procedure of terminating a conversion prior to completion is often referred to as short cycling.

The analog input is presented to the two input pins: +IN and -IN. Upon initiation of a conversion, the differential input at these pins is sampled on the internal capacitor array. The inputs are disconnected from the internal circuitry while a conversion is in progress.

The digital conversion result is clocked out by the SCLK input and is provided serially, most significant bit first, at the D_{OUT} pin. The digital data that is provided at the D_{OUT} pin is that of the conversion currently in progress. With \overline{CS} held low after the conversion is complete, the ADC121S705 continuously converts the analog input. The digital data on D_{OUT} can be clocked into the receiving device on the SCLK rising edges. See the Digital Interface section and timing diagram for more information.

1.0 REFERENCE INPUT

The externally supplied reference voltage sets the analog input range. The ADC121S705 will operate with a reference voltage in the range of 1V to V_A .

As the reference voltage is reduced, the range of input voltages corresponding to each digital output code is reduced. That is, a smaller analog input range corresponds to one LSB (Least Significant Bit). The size of one LSB is equal to twice the reference voltage divided by 4096. When the LSB size goes below the noise floor of the ADC121S705, the noise will span an increasing number of codes and overall performance will suffer. For example, dynamic signals will have their SNR degrade, while D.C. measurements will have their code uncertainty increase. Since the noise is Gaussian in nature, the effects of this noise can be reduced by averaging the results of a number of consecutive conversions.

Additionally, since offset and gain errors are specified in LSB, any offset and/or gain errors inherent in the A/D converter will increase in terms of LSB size as the reference voltage is reduced.

The reference input and the analog inputs are connected to the capacitor array through a switch matrix when the input is sampled. Hence, the only current required at the reference and at the analog inputs is a series of transient spikes.

Lower reference voltages will decrease the current pulses at the reference input and will slightly decrease the average input current. The reference current changes only slightly with temperature. See the curves, "Reference Current vs. SCLK Frequency" and "Reference Current vs. Temperature" in the Typical Performance Curves section for additional details.

2.0 ANALOG SIGNAL INPUTS

The ADC121S705 has a differential input, and the effective input voltage that is digitized is (+IN) - (-IN). As is the case with all differential input A/D converters, operation with a fully differential input signal or voltage will provide better performance than with a single-ended input. Yet, the ADC121S705 can be presented with a single-ended input.

The current required to recharge the input sampling capacitor will cause voltage spikes at +IN and -IN. Do not try to filter out these noise spikes. Rather, ensure that the transient settles out during the acquisition period (three SCLK cycles after the fall of \overline{CS}).

2.1 Differential Input Operation

With a fully differential input voltage or signal, a positive full scale output code (0111 1111 1111b or 7FFh) will be obtained when $(+IN) - (-IN) \geq V_{REF} - 1.5 \text{ LSB}$. A negative full scale code (1000 0000 0000b or 800h) will be obtained when $(+IN) - (-IN) \leq -V_{REF} + 0.5 \text{ LSB}$. This ignores gain, offset and linearity errors, which will affect the exact differential input voltage that will determine any given output code.

2.2 Single-Ended Input Operation

For single-ended operation, the non-inverting input (+IN) of the ADC121S705 should be driven with a signal or voltages that have a maximum to minimum value range that is equal to or less than twice the reference voltage. The inverting input (-IN) should be biased at a stable voltage that is halfway between these maximum and minimum values.

Since the design of the ADC121S705 is optimized for a differential input, the performance degrades slightly when driven with a single-ended input. Linearity characteristics such as INL and DNL typically degrade by 0.1 LSB and dynamic characteristics such as SINAD typically degrades by 2 dB. Note that single-ended operation should only be used if the performance degradation (compared with differential operation) is acceptable.

2.3 Input Common Mode Voltage

The allowable input common mode voltage (V_{CM}) range depends upon the supply and reference voltages used for the ADC121S705. The ranges of V_{CM} are depicted in *Figure 8* and *Figure 9*. The minimum and maximum common mode voltages for differential and single-ended operation are shown in *Table 1*.

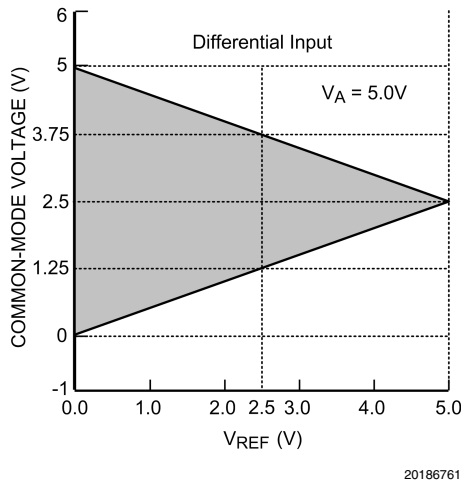

FIGURE 8. V_{CM} range for Differential Input operation

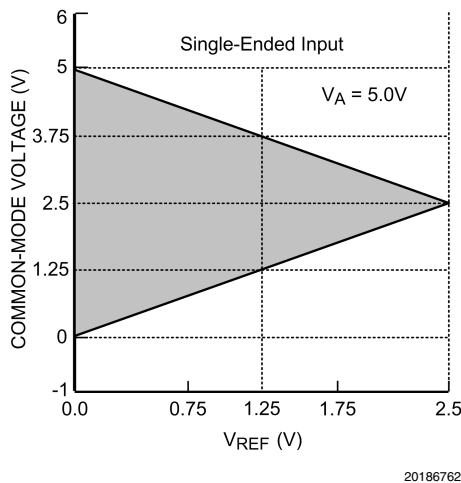

FIGURE 9. V_{CM} range for single-ended operation

TABLE 1. Allowable V_{CM} Range

Input Signal	Minimum V_{CM}	Maximum V_{CM}
Differential	$V_{REF} / 2$	$V_A - V_{REF} / 2$
Single-Ended	V_{REF}	$V_A - V_{REF}$

3.0 SERIAL DIGITAL INTERFACE

The ADC121S705 communicates via a synchronous 3-wire serial interface as shown in the Timing Diagram section. \overline{CS} , chip select, initiates conversions and frames the serial data transfers. SCLK (serial clock) controls both the conversion process and the timing of serial data. DOUT is the serial data output pin, where a conversion result is sent as a serial data stream, MSB first.

A serial frame is initiated on the falling edge of \overline{CS} and ends on the rising edge of \overline{CS} . The ADC121S705's DOUT pin is in

a high impedance state when \overline{CS} is high and is active when \overline{CS} is low; thus \overline{CS} acts as an output enable.

During the first three cycles of SCLK, the ADC121S705 is in acquisition mode (t_{ACQ}), acquiring the input voltage. For the next thirteen SCLK cycles (t_{CONV}), the conversion is accomplished and the data is clocked out. SCLK falling edges one through four clock out leading zeros while falling edges five through sixteen clock out the conversion result, MSB first. If there is more than one conversion in a frame (continuous conversion mode), the ADC121S705 will re-enter acquisition mode on the falling edge of SCLK after the $N \cdot 16$ th rising edge of SCLK and re-enter the conversion mode on the $N \cdot 16 + 4$ th falling edge of SCLK as shown in *Figure 2*. "N" is an integer value.

The ADC121S705 can enter acquisition mode under three different conditions. The first condition involves \overline{CS} going low (asserted) with SCLK high. In this case, the ADC121S705 enters acquisition mode on the first falling edge of SCLK after \overline{CS} is asserted. In the second condition, \overline{CS} goes low with SCLK low. Under this condition, the ADC121S705 automatically enters acquisition mode and the falling edge of \overline{CS} is seen as the first falling edge of SCLK. In the third condition, \overline{CS} and SCLK go low simultaneously and the ADC121S705 enters acquisition mode. While there is no timing restriction with respect to the falling edges of \overline{CS} and SCLK, see *Figure 6* for setup and hold time requirements for the falling edge of \overline{CS} with respect to the rising edge of SCLK.

3.1 \overline{CS} Input

The \overline{CS} (chip select bar) input is CMOS compatible and is active low. The ADC121S705 is in normal mode when \overline{CS} is low and power-down mode when \overline{CS} is high. \overline{CS} frames the conversion window. The falling edge of \overline{CS} marks the beginning of a conversion and the rising of \overline{CS} marks the end of a conversion window. Multiple conversions can occur within a given conversion frame with each conversion requiring sixteen SCLK cycles.

3.2 SCLK Input

The SCLK (serial clock) is used as the conversion clock and to clock out the conversion results. This input is CMOS compatible. Internal settling time requirements limit the maximum clock frequency while internal capacitor leakage limits the minimum clock frequency. The ADC121S705 offers guaranteed performance with the clock rates indicated in the electrical table.

3.3 Data Output

The output data format of the ADC121S705 is two's complement, as shown in *Table 2*. This table indicates the ideal output code for the given input voltage and does not include the effects of offset, gain error, linearity errors, or noise. Each data output bit is sent on the falling edge of SCLK.

While most receiving systems will capture the digital output bits on the rising edge of SCLK, the falling edge of SCLK may be used to capture each bit if the minimum hold time (t_{DH}) for D_{OUT} is acceptable. See *Figure 5* for DOUT hold and access times.

D_{OUT} is enabled on the falling edge of \overline{CS} and disabled on the rising edge of \overline{CS} . If \overline{CS} is raised prior to the 16th falling edge of SCLK, the current conversion is aborted and D_{OUT} will go into its high impedance state. A new conversion will begin when \overline{CS} is taken LOW.

TABLE 2. Ideal Output Code vs. Input Voltage

Description	Analog Input (+IN) – (–IN)	2's Complement Binary Output	2's Comp. Hex Code
+ Full Scale	V_{REF} – 1.5 LSB	0111 1111 1111	7FF
Midscale	0V	0000 0000 0000	000
Midscale – 1 LSB	0V – 1 LSB	1111 1111 1111	FFF
– Full Scale	$-V_{REF}$ – 0.5 LSB	1000 0000 0000	800

Applications Information

OPERATING CONDITIONS

We recommend that the following conditions be observed for operation of the ADC121S705:

$$-40^{\circ}\text{C} \leq T_A \leq +105^{\circ}\text{C}$$

$$+4.5\text{V} \leq V_A \leq +5.5\text{V}$$

$$1\text{V} \leq V_{REF} \leq V_A$$

$$8\text{ MHz} \leq f_{CLK} \leq 16\text{ MHz}$$

V_{CM} : See Section 2.3

4.0 POWER CONSUMPTION

The architecture, design, and fabrication process allow the ADC121S705 to operate at conversion rates up to 1 MSPS while consuming very little power. The ADC121S705 consumes the least amount of power while operating in power down mode. For applications where power consumption is critical, the ADC121S705 should be operated in power down mode as often as the application will tolerate. To further reduce power consumption, stop the SCLK while \overline{CS} is high.

4.1 Short Cycling

Another way of saving power is to short cycle the conversion process. This is done by pulling \overline{CS} high after the last required bit is received from the ADC121S705 output. This is possible because the ADC121S705 places the latest converted data bit on D_{OUT} as it is generated. If only 8-bits of the conversion result are needed, for example, the conversion can be terminated by pulling \overline{CS} high after the 8th bit has been clocked out. Halting the conversion after the last needed bit is outputted is called short cycling.

Short cycling can be used to lower the power consumption in those applications that do not need a full 12-bit resolution, or where an analog signal is being monitored until some condition occurs. For example, it may not be necessary to use the full 12-bit resolution of the ADC121S705 as long as the signal being monitored is within certain limits. In some circumstances, the conversion could be terminated after the first few bits. This will lower power consumption in the converter since the ADC121S705 spends more time in power down mode and less time in the conversion mode.

4.2 Burst Mode Operation

Normal operation of the ADC121S705 requires the SCLK frequency to be sixteen times the sample rate and the \overline{CS} rate to be the same as the sample rate. However, in order to minimize power consumption in applications requiring sample rates below 500 kSPS, the ADC121S705 should be run with an SCLK frequency of 16 MHz and a \overline{CS} rate as slow as the system requires. When this is accomplished, the ADC121S705 is operating in burst mode. The ADC121S705

enters into power down mode at the end of each conversion, minimizing power consumption. This causes the converter to spend the longest possible time in power down mode. Since power consumption scales directly with conversion rate, minimizing power consumption requires determining the lowest conversion rate that will satisfy the requirements of the system.

5.0 TIMING CONSIDERATIONS

Proper operation requires that the fall of \overline{CS} not occur simultaneously with a rising edge of SCLK. If the fall of \overline{CS} occurs during the rising edge of SCLK, the data might be clocked out one bit early. Whether or not the data is clocked out early depends upon how close the \overline{CS} transition is to the SCLK transition, the device temperature, and characteristics of the individual device. To ensure that the data is always clocked out at a given time (the 5th falling edge of SCLK), it is essential that the fall of \overline{CS} always meet the timing requirement specified in the Timing Specification table.

6.0 PCB LAYOUT AND CIRCUIT CONSIDERATIONS

For best performance, care should be taken with the physical layout of the printed circuit board. This is especially true with a low reference voltage or when the conversion rate is high. At high clock rates there is less time for settling, so it is important that any noise settles out before the conversion begins.

6.1 Power Supply

Any ADC architecture is sensitive to spikes on the power supply, reference, and ground pins. These spikes may originate from switching power supplies, digital logic, high power devices, and other sources. Power to the ADC121S705 should be clean and well bypassed. A 0.1 μF ceramic bypass capacitor and a 1 μF to 10 μF capacitor should be used to bypass the ADC121S705 supply, with the 0.1 μF capacitor placed as close to the ADC121S705 package as possible.

6.2 Voltage Reference

The reference source must have a low output impedance and needs to be bypassed with a minimum capacitor value of 0.1 μF . A larger capacitor value of 1 μF to 10 μF placed in parallel with the 0.1 μF is preferred. While the ADC121S705 draws very little current from the reference on average, there are higher instantaneous current spikes at the reference input that must settle out while SCLK is high. Since these transient spikes can be as high as 20 mA, it is important that the reference circuit be capable of providing this much current and settle out during the first three clock periods (acquisition time).

The reference input of the ADC121S705, like all A/D converters, does not reject noise or voltage variations. Keep this in mind if the reference voltage is derived from the power supply. Any noise and/or ripple from the supply that is not rejected by the external reference circuitry will appear in the digital results. The use of an active reference source is recommended. The LM4040 and LM4050 shunt reference families and the LM4132 and LM4140 series reference families are excellent choices for a reference source.

6.3 Power and Ground Planes

A single ground plane and the use of two or more power planes is recommended. The power planes should all be in the same board layer and will define the analog, digital, and high power board areas. Lines associated with these areas should always be routed within their respective areas.

The GND pin on the ADC121S705 should be connected to the ground plane at a quiet point. Avoid connecting the GND

pin too close to the ground point of a microprocessor, microcontroller, digital signal processor, or other high power digital device.

7.0 APPLICATION CIRCUITS

The following figures are examples of the ADC121S705 in typical application circuits. These circuits are basic and will generally require modification for specific circumstances.

7.1 Data Acquisition

Figure 10 shows a basic low cost, low power data acquisition circuit. Maximum clock rate with a minimum sample rate can reduce the power consumption further.

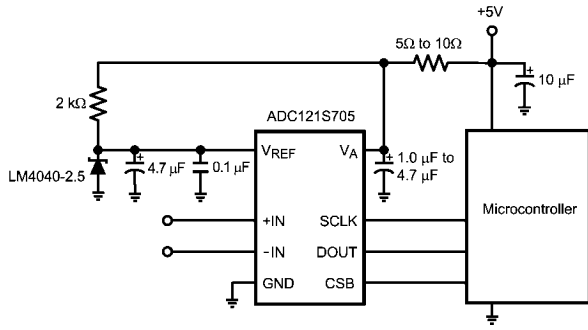

20186763

FIGURE 10. Low cost, low power Data Acquisition System

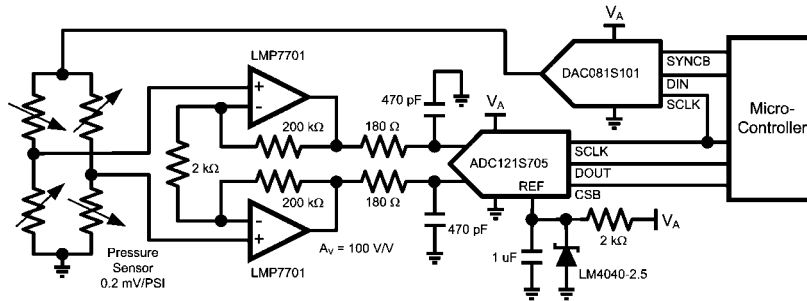

20186766

FIGURE 11. Interfacing the ADC121S705 for a Pressure Sensor

7.2 Pressure Sensor

Figure 11 shows an example of interfacing a pressure sensor to the ADC121S705. A digital-to-analog converter (DAC) is used to bias the pressure sensor. The DAC081S101 provides a means for dynamically adjusting the sensitivity of the sensor. A shunt reference voltage of 2.5V is used as the reference for the ADC121S705. The ADC121S705, DAC081S101, and the LM4040 are all powered from the same voltage source.

Physical Dimensions inches (millimeters) unless otherwise noted

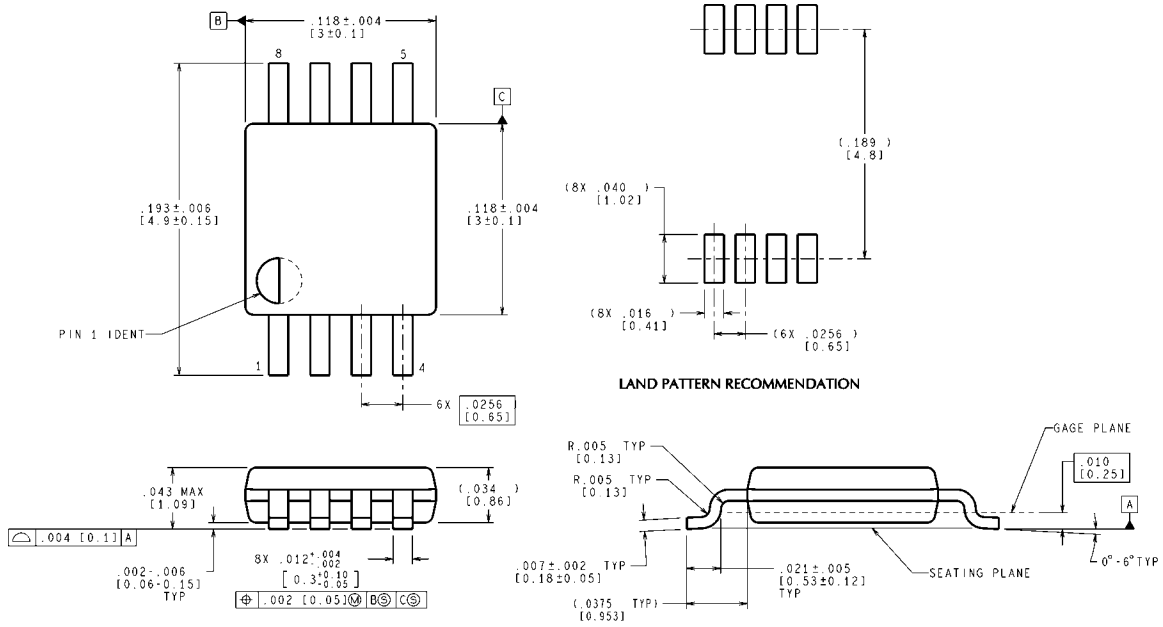

CONTROLLING DIMENSION IS INCH
VALUES IN [] ARE MILLIMETERS

MUA08A (Rev E)

8-Lead MSOP
Order Number ADC121S705C1MM
NS Package Number MUA08A

Notes

THE CONTENTS OF THIS DOCUMENT ARE PROVIDED IN CONNECTION WITH NATIONAL SEMICONDUCTOR CORPORATION ("NATIONAL") PRODUCTS. NATIONAL MAKES NO REPRESENTATIONS OR WARRANTIES WITH RESPECT TO THE ACCURACY OR COMPLETENESS OF THE CONTENTS OF THIS PUBLICATION AND RESERVES THE RIGHT TO MAKE CHANGES TO SPECIFICATIONS AND PRODUCT DESCRIPTIONS AT ANY TIME WITHOUT NOTICE. NO LICENSE, WHETHER EXPRESS, IMPLIED, ARISING BY ESTOPPEL OR OTHERWISE, TO ANY INTELLECTUAL PROPERTY RIGHTS IS GRANTED BY THIS DOCUMENT.

TESTING AND OTHER QUALITY CONTROLS ARE USED TO THE EXTENT NATIONAL DEEMS NECESSARY TO SUPPORT NATIONAL'S PRODUCT WARRANTY. EXCEPT WHERE MANDATED BY GOVERNMENT REQUIREMENTS, TESTING OF ALL PARAMETERS OF EACH PRODUCT IS NOT NECESSARILY PERFORMED. NATIONAL ASSUMES NO LIABILITY FOR APPLICATIONS ASSISTANCE OR BUYER PRODUCT DESIGN. BUYERS ARE RESPONSIBLE FOR THEIR PRODUCTS AND APPLICATIONS USING NATIONAL COMPONENTS. PRIOR TO USING OR DISTRIBUTING ANY PRODUCTS THAT INCLUDE NATIONAL COMPONENTS, BUYERS SHOULD PROVIDE ADEQUATE DESIGN, TESTING AND OPERATING SAFEGUARDS.

EXCEPT AS PROVIDED IN NATIONAL'S TERMS AND CONDITIONS OF SALE FOR SUCH PRODUCTS, NATIONAL ASSUMES NO LIABILITY WHATSOEVER, AND NATIONAL DISCLAIMS ANY EXPRESS OR IMPLIED WARRANTY RELATING TO THE SALE AND/OR USE OF NATIONAL PRODUCTS INCLUDING LIABILITY OR WARRANTIES RELATING TO FITNESS FOR A PARTICULAR PURPOSE, MERCHANTABILITY, OR INFRINGEMENT OF ANY PATENT, COPYRIGHT OR OTHER INTELLECTUAL PROPERTY RIGHT.

LIFE SUPPORT POLICY

NATIONAL'S PRODUCTS ARE NOT AUTHORIZED FOR USE AS CRITICAL COMPONENTS IN LIFE SUPPORT DEVICES OR SYSTEMS WITHOUT THE EXPRESS PRIOR WRITTEN APPROVAL OF THE CHIEF EXECUTIVE OFFICER AND GENERAL COUNSEL OF NATIONAL SEMICONDUCTOR CORPORATION. As used herein:

Life support devices or systems are devices which (a) are intended for surgical implant into the body, or (b) support or sustain life and whose failure to perform when properly used in accordance with instructions for use provided in the labeling can be reasonably expected to result in a significant injury to the user. A critical component is any component in a life support device or system whose failure to perform can be reasonably expected to cause the failure of the life support device or system or to affect its safety or effectiveness.

National Semiconductor and the National Semiconductor logo are registered trademarks of National Semiconductor Corporation. All other brand or product names may be trademarks or registered trademarks of their respective holders.

Copyright© 2007 National Semiconductor Corporation

For the most current product information visit us at www.national.com



**National Semiconductor
Americas Customer
Support Center**
Email:
new.feedback@nsc.com
Tel: 1-800-272-9959

**National Semiconductor Europe
Customer Support Center**
Fax: +49 (0) 180-530-85-86
Email: europe.support@nsc.com
Deutsch Tel: +49 (0) 69 9508 6208
English Tel: +49 (0) 870 24 0 2171
Français Tel: +33 (0) 1 41 91 8790

**National Semiconductor Asia
Pacific Customer Support Center**
Email: ap.support@nsc.com

**National Semiconductor Japan
Customer Support Center**
Fax: 81-3-5639-7507
Email: jpn.feedback@nsc.com
Tel: 81-3-5639-7560