

## FEATURES

- Software Programmable Features
  - Unipolar/Bipolar Conversion
  - Differential/Single Ended Inputs
  - MSB-First or MSB/LSB Data Sequence
  - Power Shutdown
- Built-In Sample and Hold
- Single Supply 5V or  $\pm 5V$  Operation
- Direct 4-Wire Interface to Most MPU Serial Ports and All MPU Parallel Ports
- 46.5kHz Maximum Throughput Rate
- System Shutdown Output (LTC1296)

## KEY SPECIFICATIONS

- Resolution: 12 Bits
- Fast Conversion Time: 12 $\mu$ s Max Over Temp
- Low Supply Current: 6.0mA

## DESCRIPTION

The LTC1293/4/6 is a family of data acquisition systems which contain a serial I/O successive approximation A/D converter. It uses LTCMOS™ switched capacitor technology to perform either 12-bit unipolar, or 11-bit plus sign bipolar A/D conversions. The input multiplexer can be configured for either single ended or differential inputs (or combinations thereof). An on-chip sample and hold is included for all single ended input channels. When the LTC1293/4/6 is idle it can be powered down in applications where low power consumption is desired. The LTC1296 includes a System Shutdown Output pin which can be used to power down external circuitry, such as signal conditioning circuitry prior to the input mux.

The serial I/O is designed to communicate without external hardware to most MPU serial ports and all MPU parallel I/O ports allowing up to eight channels of data to be transmitted over as few as three wires.

LTCMOS™ is a trademark of Linear Technology Corporation

## TYPICAL APPLICATION

12-Bit Data Acquisition System with Power Shutdown

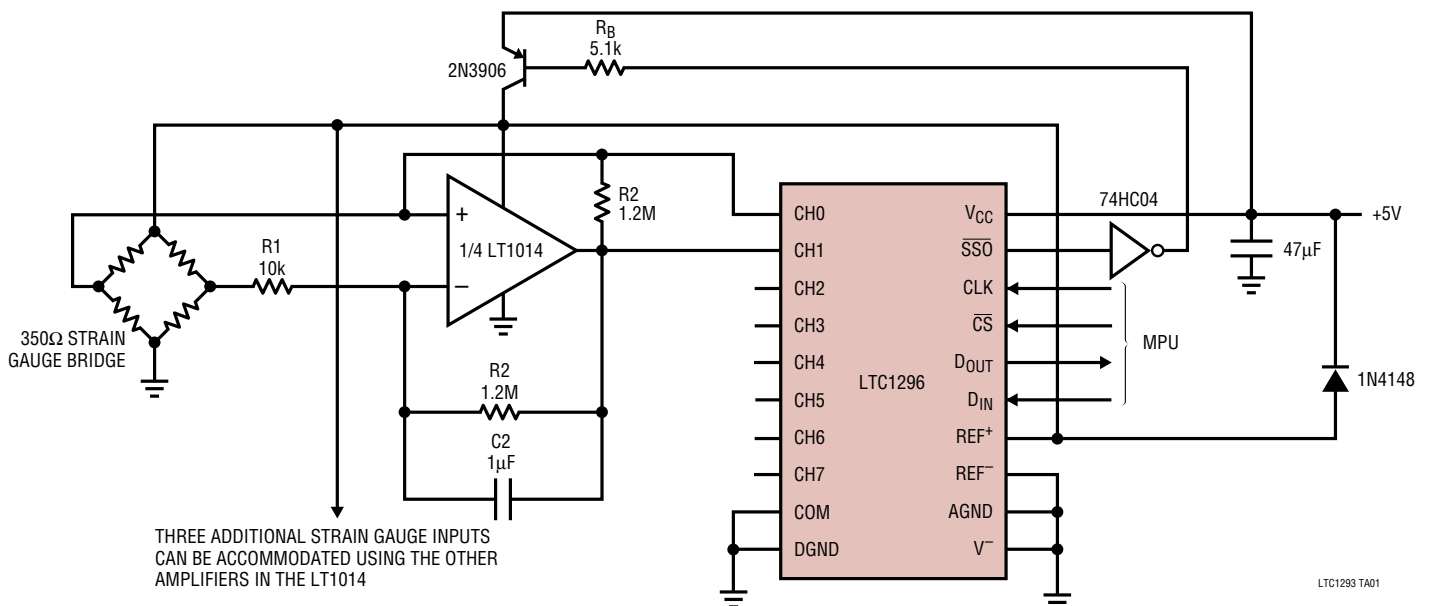

LTC1293 TA01

129346fs

# LTC1293/LTC1294/LTC1296

## ABSOLUTE MAXIMUM RATINGS (Notes 1 and 2)

Supply Voltage ( $V_{CC}$ ) to GND or $V^-$ .....	12V	Power Dissipation .....	500mW
Negative Supply Voltage ( $V^-$ ) .....	-6V to GND	Operating Temperature Range	
Voltage		LTC1293/4/6BC, LTC1293/4/6CC,	
Analog and Reference		LTC1293/4/6DC .....	0°C to 70°C
Inputs .....	( $V^-$ ) -0.3V to $V_{CC} + 0.3V$	LTC1296BI, LTC1296CI, LTC1296DI ...	-40°C to 85°C
Digital Inputs .....	-0.3V to 12V	Storage Temperature Range .....	-65°C to 150°C
Digital Outputs .....	-0.3V to $V_{CC} + 0.3V$	Lead Temperature (Soldering, 10 sec.) .....	300°C

## PACKAGE/ORDER INFORMATION (Top Views) Consult factory for Industrial and Military grades.

<p>SW PACKAGE, 16-LEAD PLASTIC SO WIDE  <math>T_{JMAX} = 110^{\circ}C</math>, <math>\theta_{JA} = 150^{\circ}C/W</math></p>	<p>ORDER PART NUMBER</p> <p>LTC1293BCSW            LTC1293CCSW            LTC1293DCSW</p>	<p>N PACKAGE, 16-LEAD PDIP  <math>T_{JMAX} = 110^{\circ}C</math>, <math>\theta_{JA} = 100^{\circ}C/W</math> (N)</p>	<p>ORDER PART NUMBER</p> <p>LTC1293BCN            LTC1293CCN            LTC1293DCN</p>
<p>SW PACKAGE, 20-LEAD PLASTIC SO WIDE  <math>T_{JMAX} = 110^{\circ}C</math>, <math>\theta_{JA} = 150^{\circ}C/W</math></p>	<p>LTC1294BCSW            LTC1294CCSW            LTC1294DCSW</p>	<p>N PACKAGE, 20-LEAD PDIP  <math>T_{JMAX} = 110^{\circ}C</math>, <math>\theta_{JA} = 100^{\circ}C/W</math> (N)</p>	<p>LTC1294BCN            LTC1294CCN            LTC1294DCN</p>
<p style="text-align: center;"><b>OBsolete PACKAGE</b>            Consider the N Package for Alternate Source</p>	<p style="text-align: center;"><b>OBsolete PACKAGE</b>            Consider the N Package for Alternate Source</p>	<p>J PACKAGE, 20-LEAD CERDIP  <math>T_{JMAX} = 150^{\circ}C</math>, <math>\theta_{JA} = 80^{\circ}C/W</math> (J)</p>	<p>LTC1294BCJ            LTC1294CCJ            LTC1294DCJ</p>
<p>SW PACKAGE, 20-LEAD PLASTIC SO WIDE  <math>T_{JMAX} = 110^{\circ}C</math>, <math>\theta_{JA} = 150^{\circ}C/W</math></p>	<p>LTC1296BCSW            LTC1296CCSW            LTC1296DCSW            LTC1296BISW            LTC1296CISW            LTC1296DISW</p>	<p>N PACKAGE, 20-LEAD PDIP  <math>T_{JMAX} = 110^{\circ}C</math>, <math>\theta_{JA} = 100^{\circ}C/W</math> (N)</p>	<p>LTC1296BIN            LTC1296CIN            LTC1296DIN            LTC1296BCN            LTC1296CCN            LTC1296DCN</p>
<p style="text-align: center;"><b>OBsolete PACKAGE</b>            Consider the N Package for Alternate Source</p>	<p style="text-align: center;"><b>OBsolete PACKAGE</b>            Consider the N Package for Alternate Source</p>	<p>J PACKAGE, 20-LEAD CERDIP  <math>T_{JMAX} = 150^{\circ}C</math>, <math>\theta_{JA} = 80^{\circ}C/W</math> (J)</p>	<p>LTC1296BCJ            LTC1296CCJ            LTC1296DCJ</p>

129346fs

**CONVERTER AND MULTIPLEXER CHARACTERISTICS** (Note 3)

PARAMETER	CONDITIONS		LTC1293/4/6B			LTC1293/4/6C			LTC1293/4/6D			UNITS
			MIN	TYP	MAX	MIN	TYP	MAX	MIN	TYP	MAX	
Offset Error	(Note 4)	●			±3.0			±3.0			±3.0	LSB
Linearity Error (INL)	(Notes 4, 5)	●			±0.5			±0.5			±0.75	LSB
Gain Error	(Note 4)	●			±0.5			±1.0			±4.0	LSB
Minimum Resolution for which No Missing Codes are Guaranteed		●			12			12			12	Bits
Analog and REF Input Range	(Note 7)		(V <sup>-</sup> ) - 0.05V to V <sub>CC</sub> + 0.05V									V
On Channel Leakage Current (Note 8)	On Channel = 5V Off Channel = 0V	●			±1			±1			±1	μA
	On Channel = 0V Off Channel = 5V	●			±1			±1			±1	μA
Off Channel Leakage Current (Note 8)	On Channel = 5V Off Channel = 0V	●			±1			±1			±1	μA
	On Channel = 0V Off Channel = 5V	●			±1			±1			±1	μA

**AC CHARACTERISTICS** (Note 3)

SYMBOL	PARAMETER	CONDITIONS		LTC1293/4/6B LTC1293/4/6C LTC1293/4/6D			UNITS
				MIN	TYP	MAX	
f <sub>CLK</sub>	Clock Frequency	V <sub>CC</sub> = 5V (Note 6)		0.1		1.0	MHz
t <sub>SMP</sub>	Analog Input Sample Time	See Operating Sequence			2.5		CLK Cycles
t <sub>CONV</sub>	Conversion Time	See Operating Sequence			12		CLK Cycles
t <sub>CYC</sub>	Total Cycle Time	See Operating Sequence (Note 6)		21 CLK +500ns			Cycles
t <sub>dDO</sub>	Delay Time, CLK↓ to D <sub>OUT</sub> Data Valid	See Test Circuits	●		160	300	ns
t <sub>dis</sub>	Delay Time, CS↑ to D <sub>OUT</sub> Hi-Z	See Test Circuits	●		80	150	ns
t <sub>en</sub>	Delay Time, CLK↓ to D <sub>OUT</sub> Enabled	See Test Circuits	●		80	200	ns
t <sub>hDI</sub>	Hold Time, D <sub>IN</sub> after CLK↑	V <sub>CC</sub> = 5V (Note 6)		50			ns
t <sub>hDO</sub>	Time Output Data Remains Valid After CLK↓				130		ns
t <sub>f</sub>	D <sub>OUT</sub> Fall Time	See Test Circuits	●		65	130	ns
t <sub>r</sub>	D <sub>OUT</sub> Rise Time	See Test Circuits	●		25	50	ns
t <sub>WHCLK</sub>	CLK High Time	V <sub>CC</sub> = 5V (Note 6)		300			ns
t <sub>WLCLK</sub>	CLK Low Time	V <sub>CC</sub> = 5V (Note 6)		400			ns
t <sub>suDI</sub>	Set-up Time, D <sub>IN</sub> Stable Before CLK↑	V <sub>CC</sub> = 5V (Note 6)		50			ns
t <sub>suCS</sub>	Set-up Time, CS↓ before CLK↑	V <sub>CC</sub> = 5V (Note 6)		50			ns
t <sub>WHCS</sub>	CS High Time During Conversion	V <sub>CC</sub> = 5V (Note 6)		500			ns
t <sub>WLCS</sub>	CS Low Time During Data Transfer	V <sub>CC</sub> = 5V (Note 6)		21			CLK Cycles
t <sub>enSSO</sub>	Delay Time, CLK↓ to SSO↓	See Test Circuits	●		750	1500	ns
t <sub>disSSO</sub>	Delay Time, CS↓ to SSO↑	See Test Circuits	●		250	500	ns
C <sub>IN</sub>	Input Capacitance	Analog Inputs On Channel Analog Inputs Off Channel Digital Inputs			100 5 5		pF

129346fs

## DIGITAL AND DC ELECTRICAL CHARACTERISTICS (Note 3)

SYMBOL	PARAMETER	CONDITIONS		LTC1293/4/6B LTC1293/4/6C LTC1293/4/6D			UNITS
				MIN	TYP	MAX	
V <sub>IH</sub>	High Level Input Voltage	V <sub>CC</sub> = 5.25V	●	2.0			V
V <sub>IL</sub>	Low Level Input Voltage	V <sub>CC</sub> = 4.75V	●			0.8	V
I <sub>IH</sub>	High Level Input Current	V <sub>IN</sub> = V <sub>CC</sub>	●			2.5	μA
I <sub>IL</sub>	Low Level Input Current	V <sub>IN</sub> = 0V	●			-2.5	μA
V <sub>OH</sub>	High Level Output Voltage	V <sub>CC</sub> = 4.75V, I <sub>O</sub> = -10mA I <sub>O</sub> = 360μA	●	2.4	4.7 4.0		V
V <sub>OL</sub>	Low Level Output Voltage	V <sub>CC</sub> = 4.75V, I <sub>O</sub> = 1.6mA	●			0.4	V
I <sub>OZ</sub>	High Z Output Leakage	V <sub>OUT</sub> = V <sub>CC</sub> , $\overline{CS}$ High V <sub>OUT</sub> = 0V, $\overline{CS}$ High	● ●			3 -3	μA
I <sub>SOURCE</sub>	Output Source Current	V <sub>OUT</sub> = 0V				-20	mA
I <sub>SINK</sub>	Output Sink Current	V <sub>OUT</sub> = V <sub>CC</sub>				20	mA
I <sub>CC</sub>	Positive Supply Current	$\overline{CS}$ High	●			6 12	mA
I <sub>CC</sub>	Positive Supply Current	$\overline{CS}$ High, Power Shutdown	●			5 10	μA
		CLK Off	●			5 15	μA
I <sub>REF</sub>	Reference Current	$\overline{CS}$ High	●			10 50	μA
I <sup>-</sup>	Negative Supply Current	$\overline{CS}$ High	●			1 50	μA
I <sub>SOURCEs</sub>	$\overline{SSO}$ Source Current	V <sub><math>\overline{SSO}</math></sub> = 0V	●	0.8	1.5		mA
I <sub>SINKs</sub>	$\overline{SSO}$ Sink Current	V <sub><math>\overline{SSO}</math></sub> = V <sub>CC</sub>	●	0.5	1.0		mA

**Note 1:** Absolute Maximum Ratings are those values beyond which the life of a device may be impaired.

**Note 2:** All voltage values are with respect to DGND, AGND and REF<sup>-</sup> wired together (unless otherwise noted).

**Note 3:** V<sub>CC</sub> = 5V, V<sub>REF+</sub> = 5V, V<sub>REF-</sub> = 0V, V<sup>-</sup> = 0V for unipolar mode and -5V for bipolar mode, CLK = 1.0MHz unless otherwise specified. The ● denotes specifications which apply over the full operating temperature range; all other limits and typicals T<sub>A</sub> = 25°C.

**Note 4:** These specs apply for both unipolar and bipolar modes. In bipolar mode, one LSB is equal to the bipolar input span (2V<sub>REF</sub>) divided by 4096. For example, when V<sub>REF</sub> = 5V, 1LSB (bipolar) = 2 (5V)/4096 = 2.44mV.

**Note 5:** Linearity error is specified between the actual end points of the A/D transfer curve. The deviation is measured from the center of the quantization band.

**Note 6:** Recommended operating conditions.

**Note 7:** Two on-chip diodes are tied to each reference and analog input which will conduct for reference or analog input voltages one diode drop below V<sup>-</sup> or one diode drop above V<sub>CC</sub>. Be careful during testing at low V<sub>CC</sub> levels (4.5V), as high level reference or analog inputs (5V) can cause this input diode to conduct, especially at elevated temperatures, and cause errors for inputs near full scale. This spec allows 50mV forward bias of either diode. This means that as long as the reference or analog input does not exceed the supply voltage by more than 50mV, the output code will be correct. To achieve an absolute 0V to 5V input voltage range will therefore require a minimum supply voltage of 4.950V over initial tolerance, temperature variations and loading.

**Note 8:** Channel leakage current is measured after the channel selection.

# TYPICAL PERFORMANCE CHARACTERISTICS

**Supply Current vs Supply Voltage**

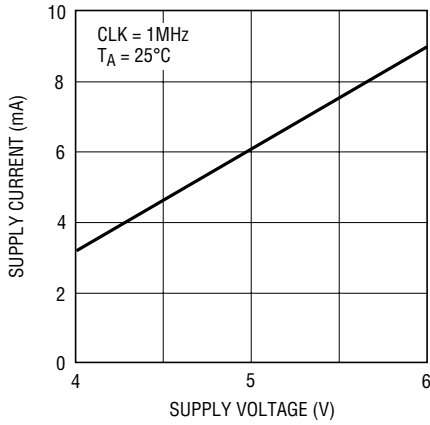

LTC1293 G01

**Supply Current vs Temperature**

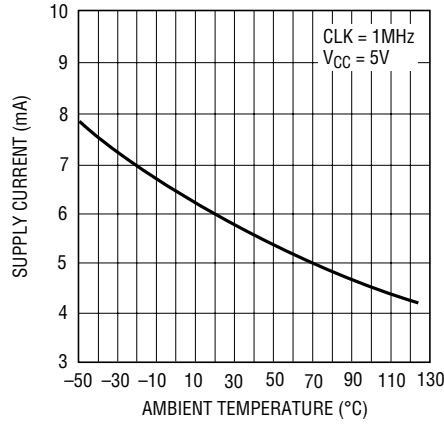

LTC1293 G02

**Unadjusted Offset Voltage vs Reference Voltage**

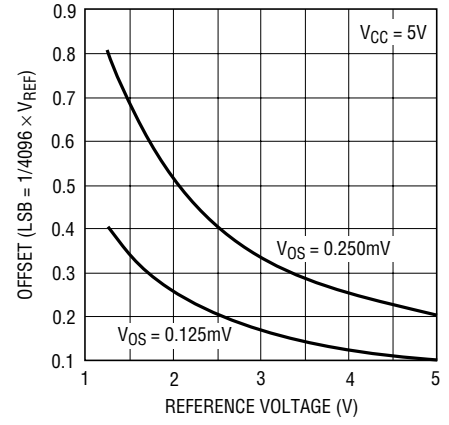

LTC1293 G03

**Change in Linearity vs Reference Voltage**

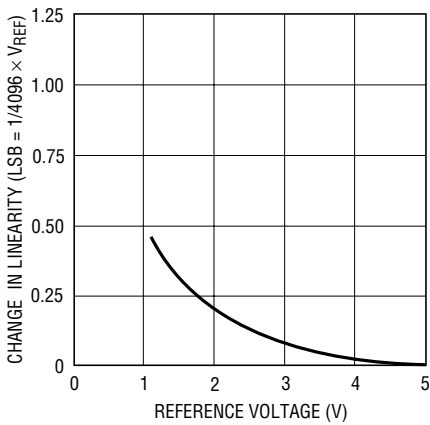

LTC1293 G04

**Change in Gain vs Reference Voltage**

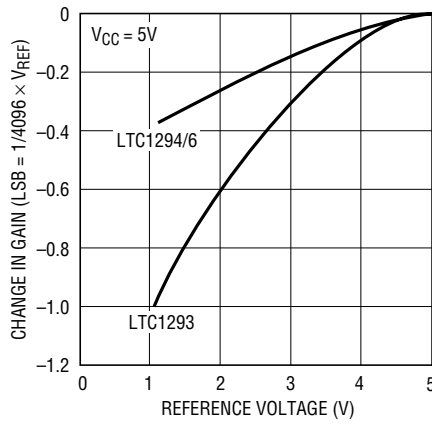

LTC1293 G05

**Change in Offset vs Temperature**

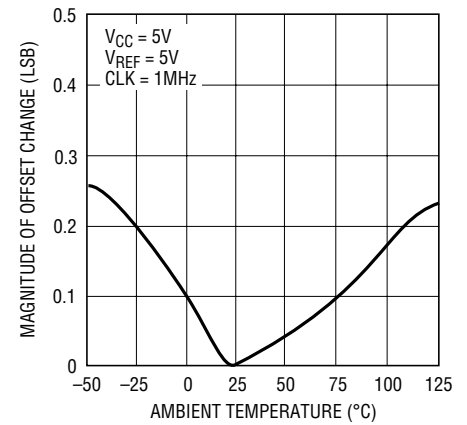

LTC1293 G06

**Change in Linearity vs Temperature**

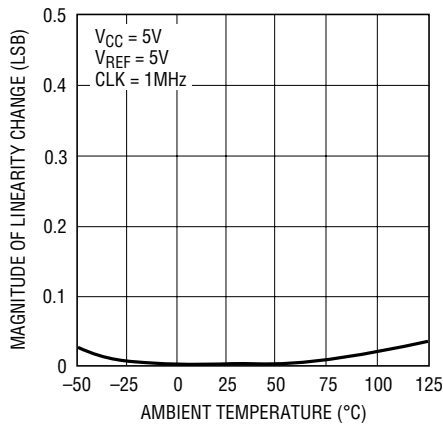

LTC1293 G07

**Change in Gain vs Temperature**

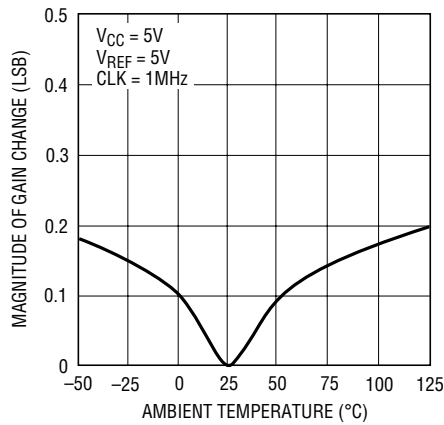

LTC1293 G08

**Minimum Clock Rate for 0.1LSB Error**

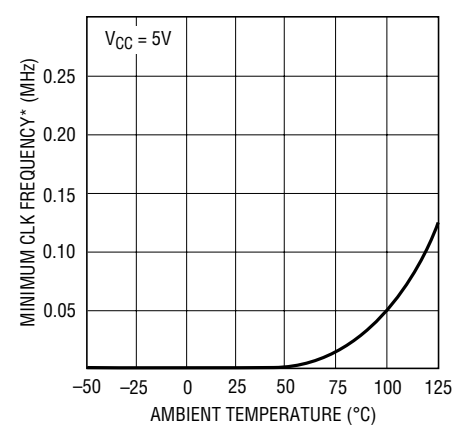

LTC1293 G09

\* AS THE CLK FREQUENCY IS DECREASED FROM 1MHz, MINIMUM CLK FREQUENCY ( $\Delta$ ERROR  $\leq$  0.1LSB) REPRESENTS THE FREQUENCY AT WHICH A 0.1LSB SHIFT IN ANY CODE TRANSITION FROM ITS 1MHz VALUE IS FIRST DETECTED.

# TYPICAL PERFORMANCE CHARACTERISTICS

**D<sub>OUT</sub> Delay Time vs Temperature**

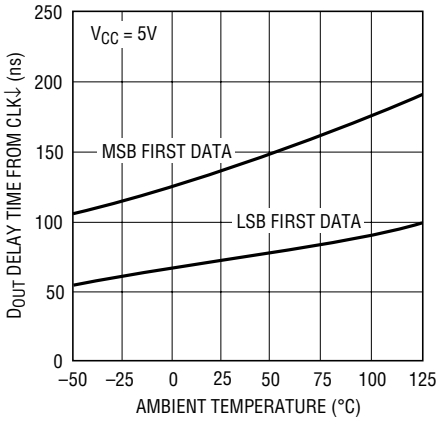

LTC1293 G10

**Maximum Clock Rate vs Source Resistance**

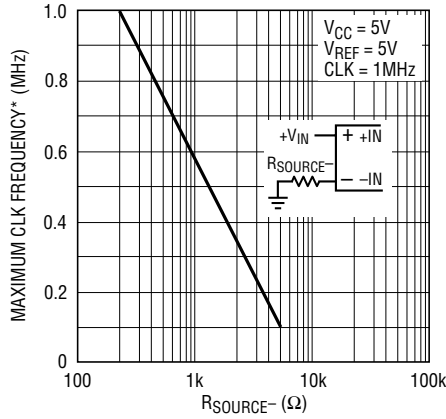

LTC1293 G11

**Maximum Filter Resistor vs Cycle Time**

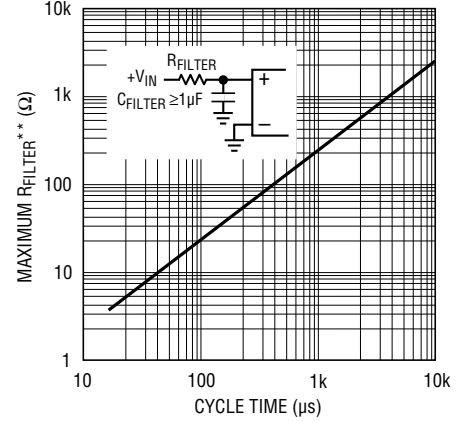

LTC1293 G12

**Sample and Hold Acquisition Time vs Source Resistance**

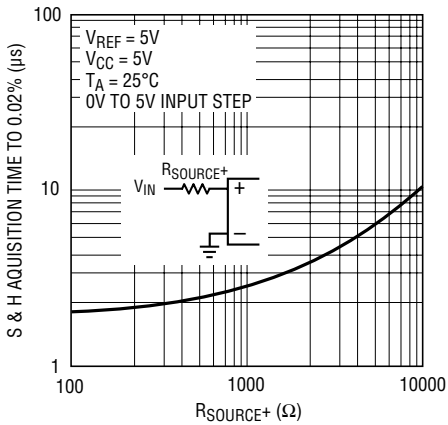

LTC1292 G13

**Input Channel leakage Current vs Temperature**

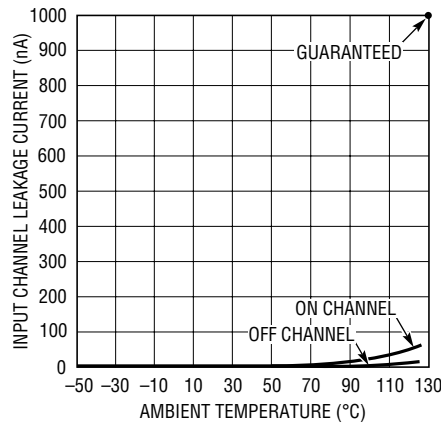

LTC1293 G14

**Noise Error vs Reference Voltage**

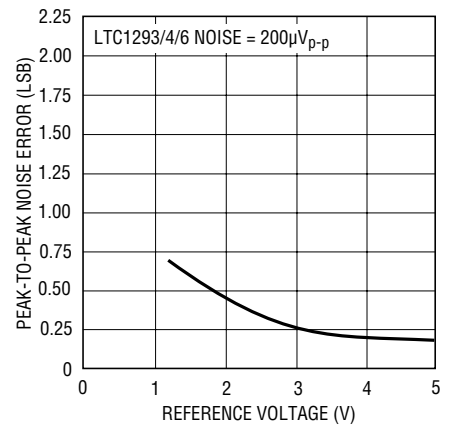

LTC1293 G15

**LTC1296 SSO Source Current vs V<sub>CC</sub> - V<sub>SS0</sub>**

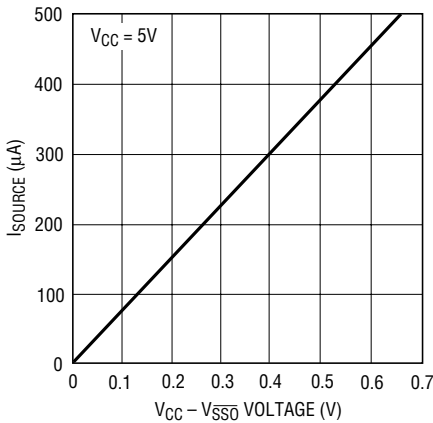

LTC1293 G16

**LTC1296 SSO Sink Current vs V<sub>SS0</sub>**

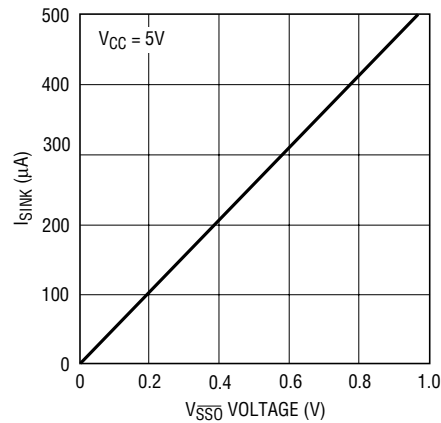

LTC1293 G17

\* MAXIMUM CLK FREQUENCY REPRESENTS THE CLK FREQUENCY AT WHICH A 0.1LSB SHIFT IN THE ERROR AT ANY CODE TRANSITION FROM ITS 1MHz VALUE IS FIRST DETECTED.

\*\* MAXIMUM R<sub>FILTER</sub> REPRESENTS THE FILTER RESISTOR VALUE AT WHICH A 0.1LSB CHANGE IN FULL SCALE ERROR FROM ITS VALUE AT R<sub>FILTER</sub> = 0Ω IS FIRST DETECTED.

## PIN FUNCTIONS

### LTC1293

#	PIN	FUNCTION	DESCRIPTION
1 – 6	CH0 – CH5	Analog Inputs	The analog inputs must be free of noise with respect to AGND.
7	COM	Common	The common pin defines the zero reference point for all single ended inputs. It must be free of noise and is usually tied to the analog ground plane.
8	DGND	Digital Ground	This is the ground for the internal logic. Tie to the ground plane.
9	V <sup>-</sup>	Negative Supply	Tie V <sup>-</sup> to most negative potential in the circuit (Ground in single supply applications).
10	AGND	Analog Ground	AGND should be tied directly to the analog ground plane.
11	V <sub>REF</sub>	Ref. Input	The reference inputs must be kept free of noise with respect to AGND.
12	D <sub>IN</sub>	Data Input	The A/D configuration word is shifted into this input.
13	D <sub>OUT</sub>	Digital Data Output	The A/D conversion result is shifted out of this output.
14	CS	Chip Select Input	A logic low on this input enables data transfer.
15	CLK	Clock	This clock synchronizes the serial data transfer and controls A/D conversion rate.
16	V <sub>CC</sub>	Positive supply	This supply must be kept free of noise and ripple by bypassing directly to the analog ground plane.

### LTC1294

#	PIN	FUNCTION	DESCRIPTION
1 – 8	CH0 – CH7	Analog Inputs	The analog inputs must be free of noise with respect to AGND.
9	COM	Common	The common pin defines the zero reference point for all single ended inputs. It must be free of noise and is usually tied to the analog ground plane.
10	DGND	Digital Ground	This is the ground for the internal logic. Tie to the ground plane.
11	V <sup>-</sup>	Negative Supply	Tie V <sup>-</sup> to most negative potential in the circuit (Ground in single supply applications).
12	AGND	Analog Ground	AGND should be tied directly to the analog ground plane.
13, 14	REF <sup>-</sup> , REF <sup>+</sup>	Ref. Inputs	The reference inputs must be kept free of noise with respect to AGND. The A/D sees a reference voltage equal to the difference between REF <sup>+</sup> and REF <sup>-</sup> .
15	D <sub>IN</sub>	Data Input	The A/D configuration word is shifted into this input.
16	D <sub>OUT</sub>	Digital Data Output	The A/D conversion result is shifted out of this output.
17	CS	Chip Select Input	A logic low on this input enables data transfer.
18	CLK	Clock	This clock synchronizes the serial data transfer and controls A/D conversion rate.
19, 20	AV <sub>CC</sub> , DV <sub>CC</sub>	Positive Supplies	These supplies must be kept free of noise and ripple by bypassing directly to the analog ground plane. AV <sub>CC</sub> and DV <sub>CC</sub> must be tied together.

### LTC1296

#	PIN	FUNCTION	DESCRIPTION
1 – 8	CH0 – CH7	Analog Inputs	The analog inputs must be free of noise with respect to AGND.
9	COM	Common	The common pin defines the zero reference point for all single ended inputs. It must be free of noise and is usually tied to the analog ground plane.
10	DGND	Digital Ground	This is the ground for the internal logic. Tie to the ground plane.
11	V <sup>-</sup>	Negative Supply	Tie V <sup>-</sup> to most negative potential in the circuit (Ground in single supply applications).
12	AGND	Analog Ground	AGND should be tied directly to the analog ground plane.
13, 14	REF <sup>-</sup> , REF <sup>+</sup>	Ref. Inputs	The reference inputs must be kept free of noise with respect to AGND. The A/D sees a reference voltage equal to the difference between REF <sup>+</sup> and REF <sup>-</sup> .
15	D <sub>IN</sub>	Data Input	The A/D configuration word is shifted into this input.
16	D <sub>OUT</sub>	Digital Data Output	The A/D conversion result is shifted out of this output.
17	CS	Chip Select Input	A logic low on this input enables data transfer.
18	CLK	Clock	This clock synchronizes the serial data transfer and controls A/D conversion rate.
19	SSO	System Shutdown Output	System Shutdown Output pin will go low when power shutdown is requested.
20	V <sub>CC</sub>	Positive Supply	This supply must be kept free of noise and ripple by bypassing directly to the analog ground plane.

## BLOCK DIAGRAM (Pin numbers refer to LTC1294)

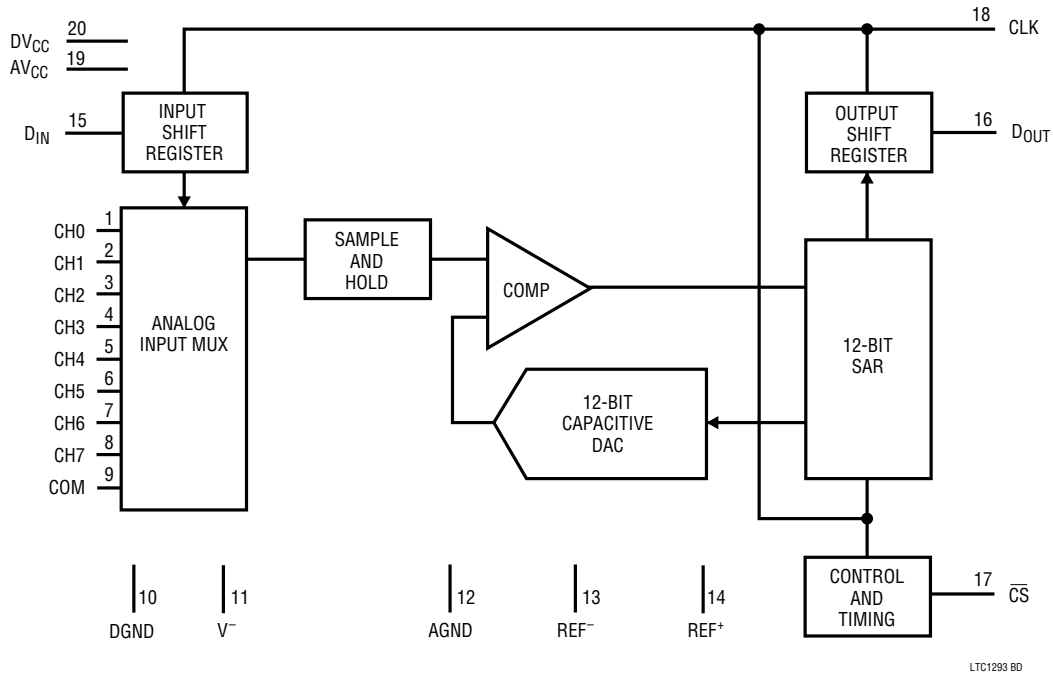

## TEST CIRCUITS

Load Circuit for  $t_{dDO}$ ,  $t_r$  and  $t_f$

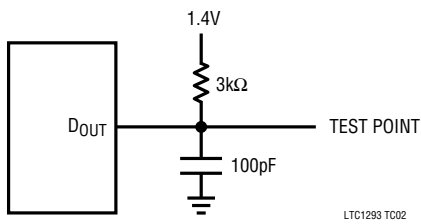

Load Circuit for  $t_{enSSO}$  and  $t_{disSSO}$

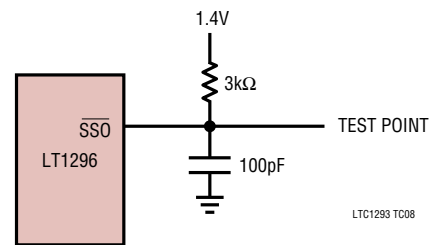

Load Circuit for  $t_{dis}$  and  $t_{en}$

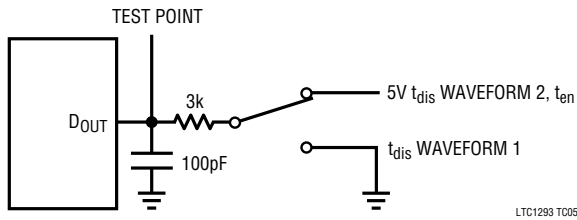

On and Off Channel Leakage Current

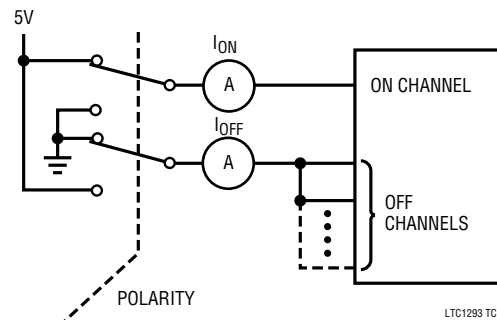



# TEST CIRCUITS

Voltage Waveforms for  $t_{en}$

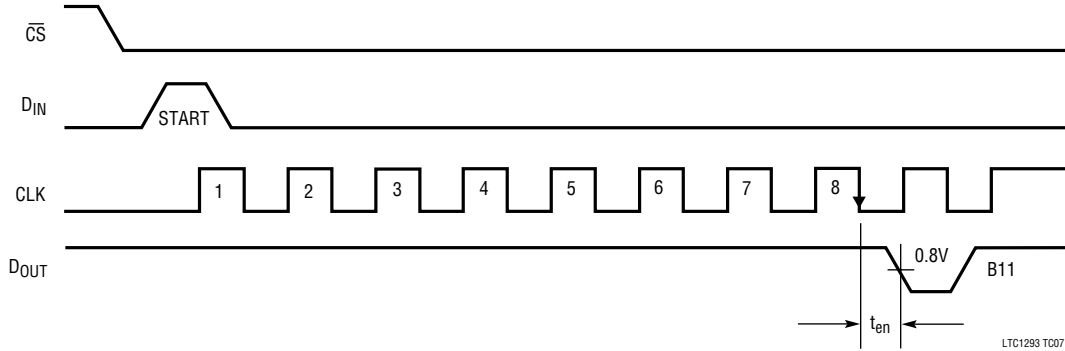

Voltage Waveform for  $t_{disSSO}$

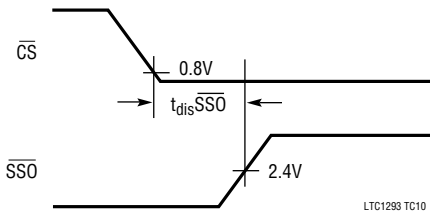

Voltage Waveform for  $D_{OUT}$  Rise and Fall Times,  $t_r$ ,  $t_f$

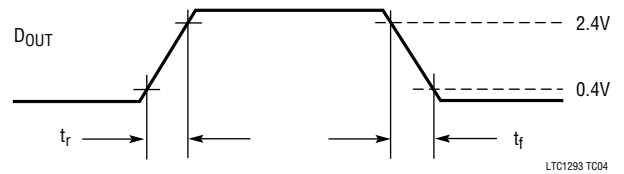

Voltage Waveform for  $t_{enSSO}$

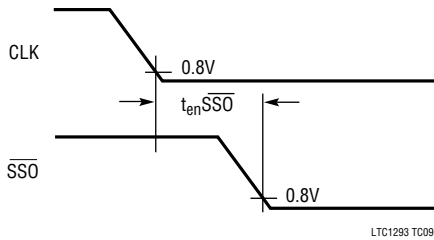

Voltage Waveform for  $t_{dis}$

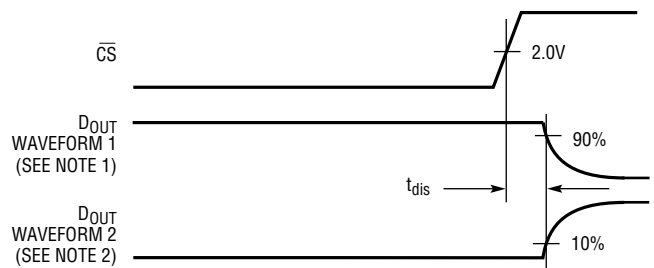

Voltage Waveform for  $D_{OUT}$  Delay Time,  $t_{dDO}$

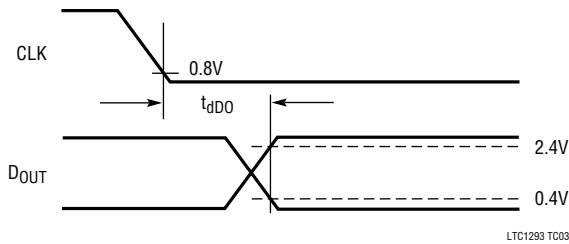

**NOTE 1:** WAVEFORM 1 IS FOR AN OUTPUT WITH INTERNAL CONDITIONS SUCH THAT THE OUTPUT IS HIGH UNLESS DISABLED BY THE OUTPUT CONTROL.  
**NOTE 2:** WAVEFORM 2 IS FOR AN OUTPUT WITH INTERNAL CONDITIONS SUCH THAT THE OUTPUT IS LOW UNLESS DISABLED BY THE OUTPUT CONTROL.

## APPLICATIONS INFORMATION

The LTC 1293/4/6 is a data acquisition component which contains the following functional blocks:

1. 12-bit successive approximation capacitive A/D converter
2. Analog multiplexer (MUX)
3. Sample and hold (S/H)
4. Synchronous, half duplex serial interface
5. Control and timing logic

### DIGITAL CONSIDERATIONS

#### Serial Interface

The LTC1293/4/6 communicates with microprocessors and other external circuitry via a synchronous, half duplex, four-wire serial interface (see Operating Sequence). The clock (CLK) synchronizes the data transfer with each bit being transmitted on the falling CLK edge and captured on the rising CLK edge in both transmitting and receiving systems. The input data is first received and then the A/D conversion result is transmitted (half duplex). Because of

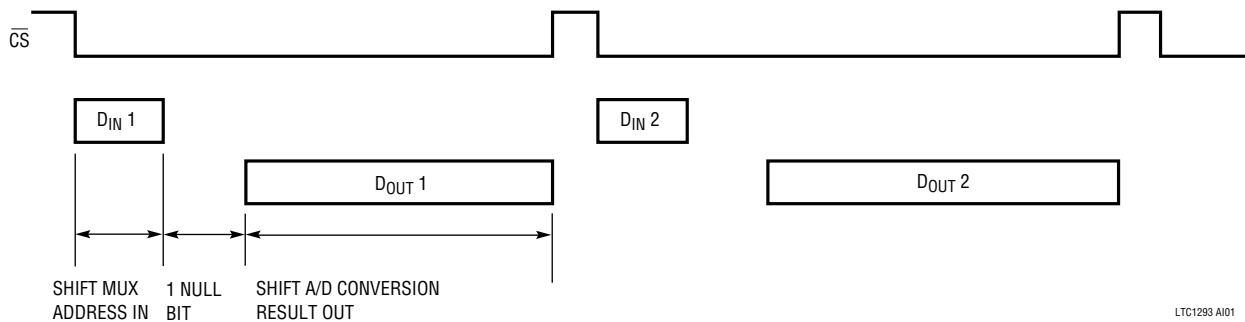

the half duplex operation  $D_{IN}$  and  $D_{OUT}$  may be tied together allowing transmission over just 3 wired:  $\overline{CS}$ , CLK and DATA ( $D_{IN}/D_{OUT}$ ). Data transfer is initiated by a falling chip select ( $\overline{CS}$ ) signal. After  $\overline{CS}$  falls the LTC1293/4/6 looks for a start bit. After the start bit is received a 7-bit input word is shifted into the  $D_{IN}$  input which configures the LTC1293/4/6 and starts the conversion. After one null bit, the result of the conversion is output on the  $D_{OUT}$  line. With the half duplex serial interface the  $D_{OUT}$  data is from the current conversion. After the end of the data exchange  $\overline{CS}$  should be brought high. This resets the LTC1293/4/6 in preparation for the next data exchange.

### INPUT DATA WORD

The LTC1293/4/6 seven-bit data word is clocked into the  $D_{IN}$  input on the rising edge of the clock after chip select goes low and the start bit has been recognized. Further inputs on the  $D_{IN}$  pin are then ignored until the next  $\overline{CS}$  cycle. The input word is defined as follows:

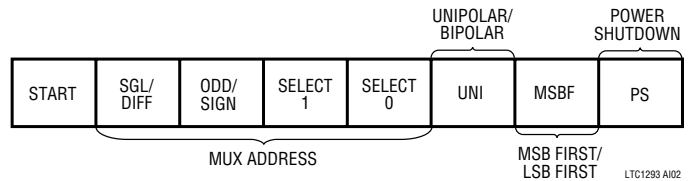

#### Start Bit

The first "logical one" clocked into the  $D_{IN}$  input after  $\overline{CS}$  goes low is the start bit. The start bit initiates the data transfer and all leading zeroes which precede this logical one will be ignored. After the start bit is received the remaining bits of the input word will be clocked in. Further inputs on the  $D_{IN}$  pin are then ignored until the next  $\overline{CS}$  cycle.

### MUX Address

The four bits of the input word following the START BIT assign the MUX configuration for the requested conversion. For a given channel selection, the converter will measure the voltage between the two channels indicated by the + and - signs in the selected row of the following table. Note that in differential mode (SGL/DIFF = 0) measurements are limited to four adjacent input pairs with either polarity. In single ended mode, all input channels are measured with respect to COM. Only the +inputs have sample and holds. Signals applied at the -inputs must not change more than the required accuracy during the conversion.

# APPLICATIONS INFORMATION

Table 1a. LTC1294/6 Multiplexer Channel Selection

MUX ADDRESS			DIFFERENTIAL CHANNEL SELECTION							MUX ADDRESS			SINGLE-ENDED CHANNEL SELECTION										
SGL/DIFF	ODD SIGN	SELECT 1 0	0	1	2	3	4	5	6	7	SGL/DIFF	ODD SIGN	SELECT 1 0	0	1	2	3	4	5	6	7	COM	
0	0	0 0	+	-							1	0	0 0	+									-
0	0	0 1			+	-					1	0	0 1			+							-
0	0	1 0					+	-			1	0	1 0					+					-
0	0	1 1							+	-	1	0	1 1							+			-
0	1	0 0	-	+							1	1	0 0		+								-
0	1	0 1			-	+					1	1	0 1				+						-
0	1	1 0					-	+			1	1	1 0						+				-
0	1	1 1							-	+	1	1	1 1								+		-

Table 1b. LTC1293 Channel Selection

MUX ADDRESS			DIFFERENTIAL CHANNEL SELECTION					MUX ADDRESS			SINGLE-ENDED CHANNEL SELECTION							
SGL/DIFF	ODD SIGN	SELECT 1 0	0	1	2	3	4	5	SGL/DIFF	ODD SIGN	SELECT 1 0	0	1	2	3	4	5	COM
0	0	0 0	+	-					1	0	0 0	+						-
0	0	0 1			+	-			1	0	0 1			+				-
0	0	1 0					+	-	1	0	1 0					+		-
0	0	1 1	Not Used					1	0	1 1	Not Used							
0	1	0 0	-	+					1	1	0 0		+					-
0	1	0 1			-	+			1	1	0 1				+			-
0	1	1 0					-	+	1	1	1 0						+	-
0	1	1 1	Not Used					1	1	1 1	Not Used							

## Unipolar/Bipolar (UNI)

The UNI bit determines whether the conversion will be unipolar or bipolar. When UNI is a logical one, a unipolar conversion will be performed on the selected input volt-

age. When UNI is a logical zero, a bipolar conversion will result. The input span and code assignment for each conversion type are shown in the figures below:

Unipolar Transfer Curve (UNI = 1)

OUTPUT CODE	INPUT VOLTAGE	INPUT VOLTAGE (VREF = 5V)
111111111111	$V_{REF} - 1LSB$	4.9988V
111111111110	$V_{REF} - 2LSB$	4.9976V
⋮	⋮	⋮
000000000001	1LSB	0.0012V
000000000000	0V	0V

LTC1293 AI03a

Unipolar Output Code (UNI = 1)

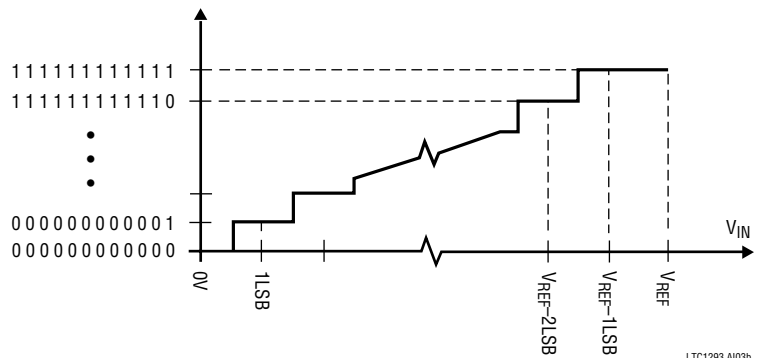

LTC1293 AI03b

## APPLICATIONS INFORMATION

Bipolar Transfer Curve (UNI = 0)

OUTPUT CODE	INPUT VOLTAGE	INPUT VOLTAGE (V <sub>REF</sub> = 5V)	OUTPUT CODE	INPUT VOLTAGE	INPUT VOLTAGE (V <sub>REF</sub> = 5V)
01111111111111	V <sub>REF</sub> - 1LSB	4.9976V	11111111111111	-1LSB	-0.0024V
01111111111110	V <sub>REF</sub> - 2LSB	4.9851V	11111111111110	-2LSB	-0.0048V
⋮	⋮	⋮	⋮	⋮	⋮
00000000000001	1LSB	0.0024V	10000000000001	-(V <sub>REF</sub> ) + 1LSB	-4.9976V
00000000000000	0V	0V	10000000000000	-(V <sub>REF</sub> )	-5.0000V

LTC1293 AI04a

Bipolar Output Code (UNI = 0)

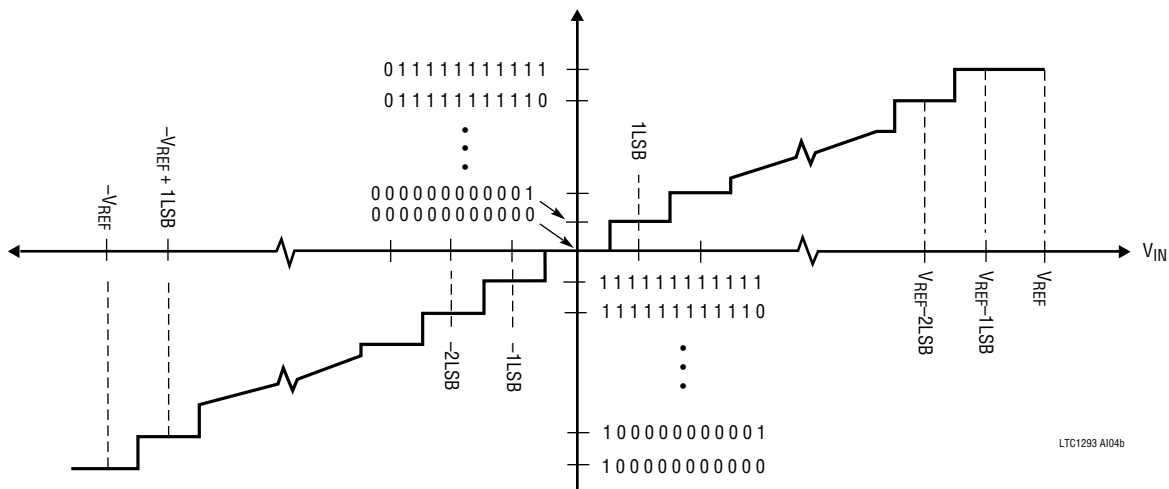

LTC1293 AI04b

The following discussion will demonstrate how the two reference pins are to be used in conjunction with the analog input multiplexer. In unipolar mode the input span of the A/D is set by the difference in voltage on the REF<sup>+</sup> pin and the REF<sup>-</sup> pin. In the bipolar mode the input span is twice the difference in voltage on the REF<sup>+</sup> pin and the REF<sup>-</sup> pin. In the unipolar mode the lower value of the input span is set by the voltage on the COM pin for single-ended inputs and by the voltage on the minus input pin for differential inputs. For the bipolar mode of operation the voltage on the COM pin or the minus input pin set the center of the input span.

The upper and lower value of the input span can now be summarized in the following table:

INPUT CONFIGURATION		UNIPOLAR MODE	BIPOLAR MODE
Single-Ended	Lower Value	COM	-(REF <sup>+</sup> - REF <sup>-</sup> ) + COM
	Upper Value	(REF <sup>+</sup> - REF <sup>-</sup> ) + COM	(REF <sup>+</sup> - REF <sup>-</sup> ) + COM
Differential	Lower Value	IN <sup>-</sup>	-(REF <sup>+</sup> - REF <sup>-</sup> ) + IN <sup>-</sup>
	Upper Value	(REF <sup>+</sup> - REF <sup>-</sup> ) + IN <sup>-</sup>	(REF <sup>+</sup> - REF <sup>-</sup> ) + IN <sup>-</sup>

The reference voltages REF<sup>+</sup> and REF<sup>-</sup> can fall between V<sub>CC</sub> and V<sup>-</sup>, but the difference (REF<sup>+</sup> - REF<sup>-</sup>) must be less than or equal to V<sub>CC</sub>. The input voltages must be less than or equal to V<sub>CC</sub> and greater than or equal to V<sup>-</sup>. For the LTC1293 REF<sup>-</sup> = 0V.

The following examples are for a single-ended input configuration.

**Example 1:** Let V<sub>CC</sub> = 5V, V<sup>-</sup> = 0V, REF<sup>+</sup> = 4V, REF<sup>-</sup> = 1V and COM = 0V. Unipolar mode of operation. The resulting input span is 0V ≤ IN<sup>+</sup> ≤ 3V.

## APPLICATIONS INFORMATION

**Example 2:** The same conditions as Example 1 except  $COM = 1V$ . The resulting input span is  $1V \leq IN^+ \leq 4V$ . Note if  $IN^+ \geq 4V$  the resulting  $D_{OUT}$  word is all 1's. If  $IN^+ \leq 1V$  then the resulting  $D_{OUT}$  word is all 0's.

**Example 3:** Let  $V_{CC} = 5V$ ,  $V^- = -5V$ ,  $REF^+ = 4V$ ,  $REF^- = 1V$  and  $COM = 1V$ . Bipolar mode of operation. The resulting input span is  $-2V \leq IN^+ \leq 4V$ .

For differential input configurations with the same conditions as in the above three examples the resulting input spans are as follows:

**Example 1 (Diff.):**  $IN^- \leq IN^+ \leq IN^- + 3V$ .

**Example 2 (Diff.):**  $IN^- \leq IN^+ \leq IN^- + 3V$ .

**Example 3 (Diff.):**  $IN^- - 3V \leq IN^+ \leq IN^- + 3V$ .

### MSB-First/LSB-First (MSBF)

The output data of the LTC1293/4/6 is programmed for MSB-first or LSB-first sequence using the MSBF bit. When the MSBF bit is a logical one, data will appear on the  $D_{OUT}$  line in MSB-first format. Logical zeroes will be filled in indefinitely following the last data bit to accommodate longer word lengths required by some microprocessors. When the MSBF bit is a logical zero, LSB first data will follow the normal MSB first data on the  $D_{OUT}$  line. In the bipolar mode the sign bit will fill in after the MSB bit for  $MSBF = 0$  (see Operating Sequence).

### Power Shutdowns (PS)

The power shutdown feature of the LTC1293/4/6 is activated by making the PS bit a logical zero. If  $\overline{CS}$  remains low after the PS bit has been received, a 12-bit  $D_{OUT}$  word with

**Operating Sequence**  
Example: Differential Inputs ( $CH4^+$ ,  $CH5^-$ ), Unipolar Mode

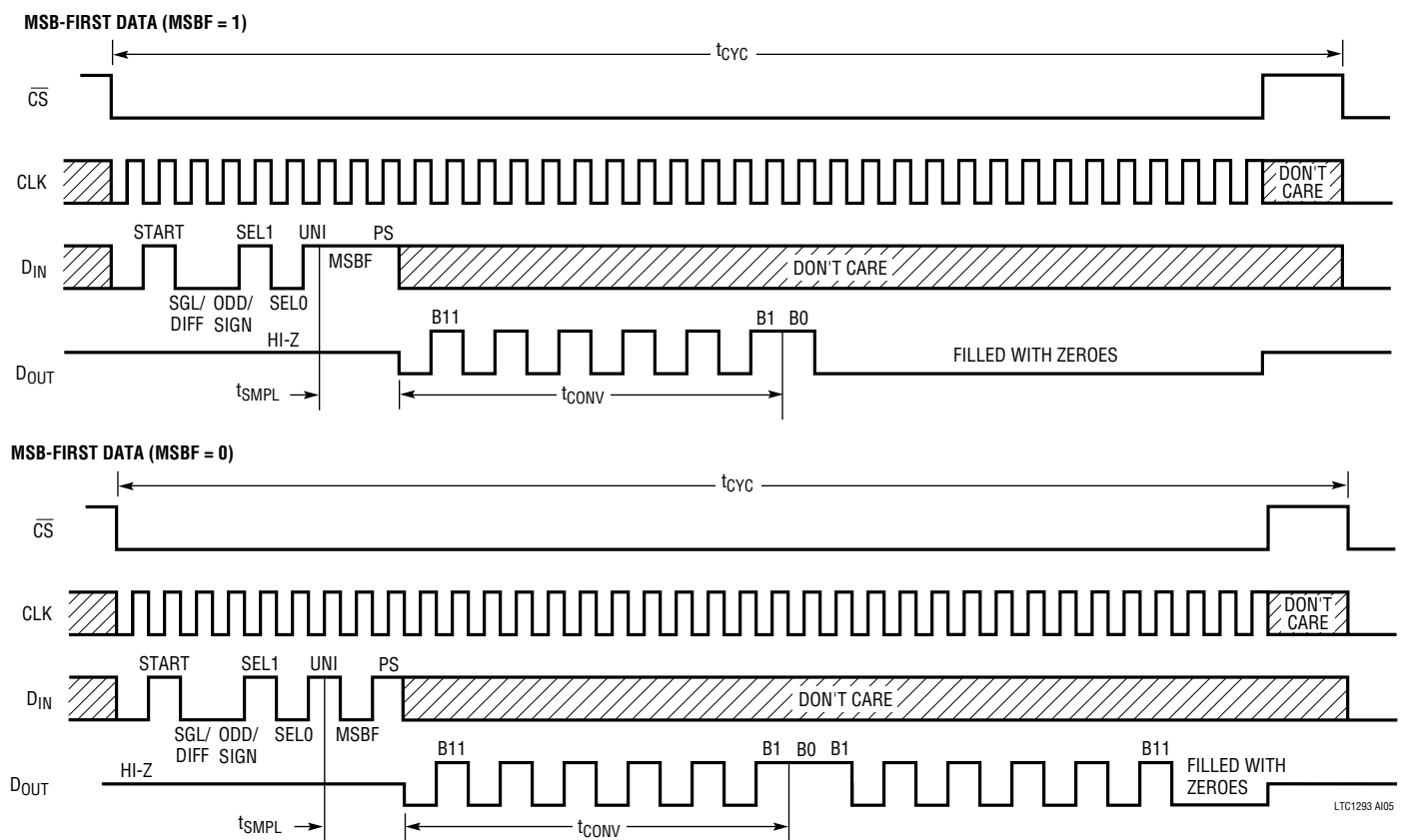

## APPLICATIONS INFORMATION

**Power Shutdown Operating Sequence**  
**Example: Differential Inputs (CH4<sup>+</sup>, CH5<sup>-</sup>), Unipolar Mode and MSB-First Data**

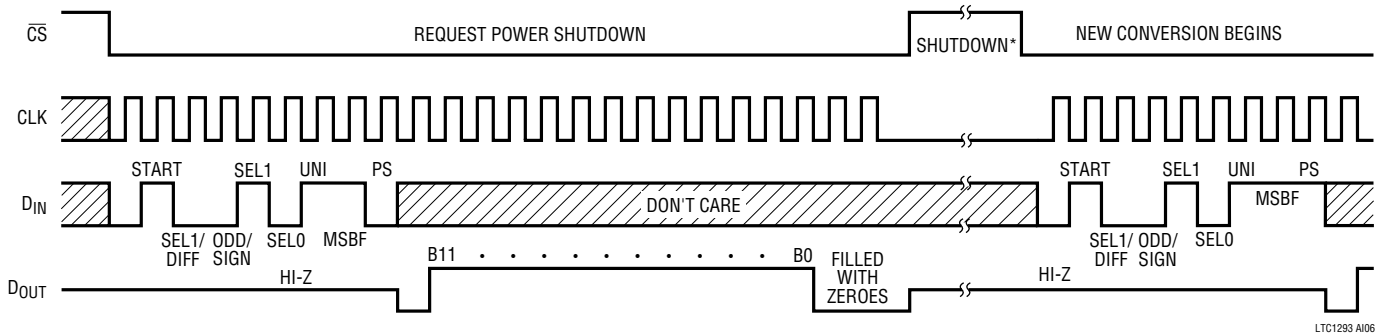

\*STOPPING THE CLOCK WILL HELP REDUCE POWER CONSUMPTION.  
 CS CAN BE BROUGHT HIGH ONCE THE DIN WORD HAS BEEN CLOCKED IN.

all logical ones will be shifted out followed by logical zeroes till  $\overline{CS}$  goes high. Then the  $D_{OUT}$  line will go into its high impedance state. The LTC 1293/4/6 will remain in the shutdown mode till the next  $\overline{CS}$  cycle. There is no warm-up or wait period required after coming out of the power shutdown cycle so a conversion can commence after  $\overline{CS}$  goes low (see Power Shutdown Operating Sequence). The LTC1296 has a System Shutdown Output pin ( $\overline{SSO}$ ) which will go low when power shutdown is activated. The pin will stay low till next  $\overline{CS}$  cycle.

### Microprocessor Interfaces

The LTC1293/4/6 can interface directly (without external hardware) to most popular microprocessors (MPU) synchronous serial formats (see Table 1). If an MPU without a dedicated serial port is used, then three of the MPU's parallel port lines can be programmed to form the serial link to the LTC1293/4/6. Included here are one serial interface example and one example showing a parallel port programmed to form the serial interface.

### Microprocessor Interfaces

The LTC1293/4/6 can interface directly (without external hardware) to most popular microprocessors (MPU) synchronous serial formats (see Table 1). If an MPU without a dedicated serial port is used, then three of the MPU's parallel port lines can be programmed to form the serial link to the LTC1293/4/6.

**Table 1. Microprocessor with Hardware Serial Interfaces Compatible with the LTC1293/4/6\*\***

PART NUMBER	TYPE OF INTERFACE
<b>Motorola</b> MC6805S2, S3 MC68HC11 MC68HC05	SPI SPI SPI
<b>RCA</b> CDP68HC05	SPI
<b>Hitachi</b> HD6305 HD6301 HD63701 HD6303 HD64180	SCI Synchronous SCI Synchronous SCI Synchronous SCI Synchronous SCI Synchronous
<b>National Semiconductor</b> COP400 Family COP800 Family NS8050U HPC16000 Family	MICROWIRE <sup>†</sup> MICROWIRE/PLUS <sup>†</sup> MICROWIRE/PLUS MICROWIRE/PLUS
<b>Texas Instruments</b> TMS7002 TMS7042 TMS70C02 TMS70C42 TMS32011* TMS32020* TMS370C050	Serial Port Serial Port Serial Port Serial Port Serial Port Serial Port SPI

\* Requires external hardware

\*\* Contact factory for interface information for processors not on this list

<sup>†</sup> MICROWIRE and MICROWIRE/PLUS are trademarks of National Semiconductor Corp.

## APPLICATIONS INFORMATION

### Motorola SPI (MC68HC11)

The MC68HC11 has been chosen as an example of an MPU with a dedicated serial port. This MPU transfers data MSB-first and in 8-bit increments. The  $D_{IN}$  word sent to the data register starts the SPI process. With three 8-bit transfers, the A/D result is read into the MPU. The second 8-bit transfer clocks B11 through B8 of the A/D conversion result into the processor. The third 8-bit transfer clocks the remaining bits B7 through B0 into the MPU. The data is right justified in the two memory locations. ANDing the second byte with  $0D_{HEX}$  clears the four most significant bits. This operation was not included in the code. It can be inserted in the data gathering loop or outside the loop when the data is processed.

### Interfacing to the Parallel Port of the Intel 8051 Family

The Intel 8051 has been chosen to show the interface between the LTC1293/4/6 and parallel port microprocessors. Usually the signals  $\overline{CS}$ ,  $D_{IN}$  and CLK are generated on three port lines and the  $D_{OUT}$  signal is read on a fourth port line. This works very well. One can save a line by tying the  $D_{IN}$  and  $D_{OUT}$  lines together. The 8051 first sends the start bit and  $D_{IN}$  to the LTC1294 over the line connected to P1.2. Then P1.2 is reconfigured as an input and the 8051 reads back the 12-bit A/D result over the same data line.

Data Exchange Between LTC1294 and MC68HC11

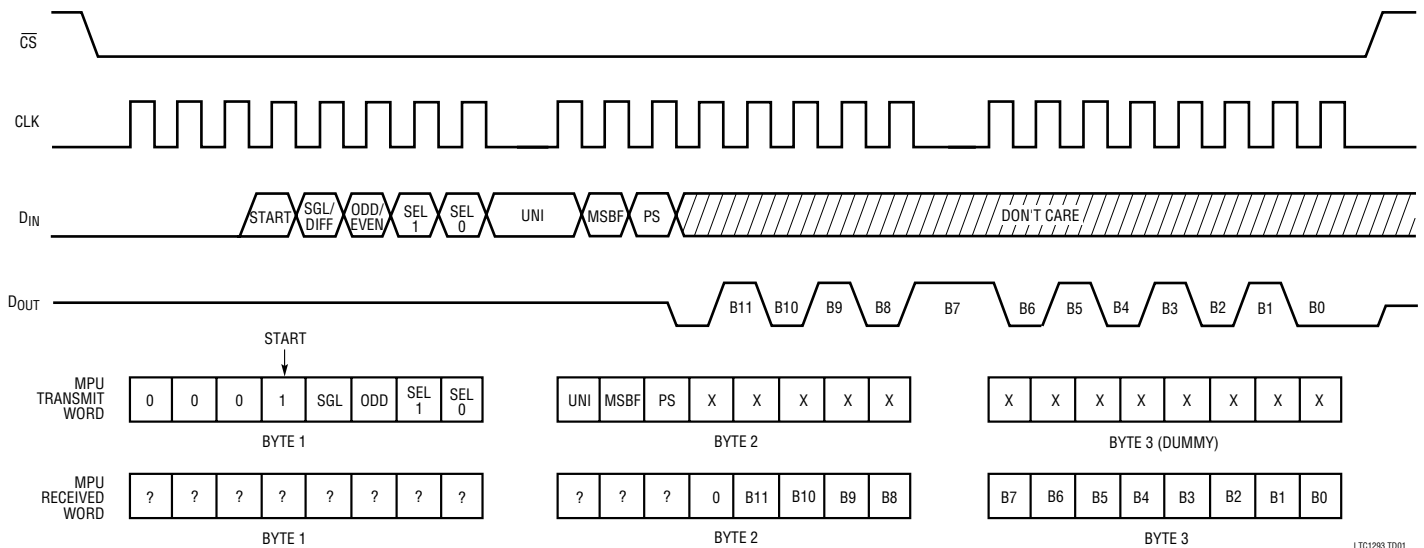

### Hardware and Software Interface to Motorola MC68HC11

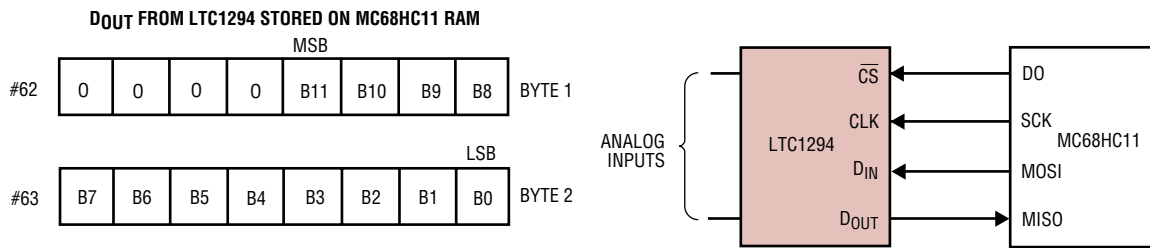

# APPLICATIONS INFORMATION

## MC68HC11 CODE

LABEL	MNEMONIC	OPERAND	COMMENTS	LABEL	MNEMONIC	OPERAND	COMMENTS
	LDA	#\$50	CONFIGURATION DATA FOR SPCR		STAA	\$102A	LOAD DIN INTO SPI, START SCK
	STAA	\$1028	LOAD DATA INTO SPCR (\$1028)	WAIT2	LDA	\$1029	CHECK SPI STATUS REG
	LDA	#\$1B	CONFIG. DATA FOR PORT D DDR		BPL	WAIT2	CHECK IF TRANSFER IS DONE
	STAA	\$1009	LOAD DATA INTO PORT D DDR		LDA	\$102A	LOAD LTC1294 MSBs INTO ACC A
	LDA	#\$10	LOAD DIN WORD INTO ACC A		STAA	\$62	STORE MSBs IN \$62
	STAA	\$50	LOAD DIN DATA INTO \$50		LDA	\$52	LOAD DUMMY DIN INTO ACC A FROM \$52
	LDA	#\$E0	LOAD DIN WORD INTO ACC A		STAA	\$102A	LOAD DUMMY DIN INTO SPI, START SCK
	STAA	\$51	LOAD DIN DATA INTO \$51	WAIT3	LDA	\$1029	CHECK SPI STATUS REG
	LDA	#\$00	LOAD DUMMY DIN WORD INTO ACC A		BPL	WAIT3	CHECK IF TRANSFER IS DONE
	STAA	\$52	LOAD DUMMY DIN DATA INTO \$52		BSET	\$08,X,\$01	DO GOES HIGH ( $\overline{CS}$ GOES HIGH)
	LDX	#\$1000	LOAD INDEX REGISTER X WITH \$1000		LDA	\$102A	LOAD LTC1294 LSBs IN ACC
LOOP	BCLR	\$08,X,\$01	DO GOES LOW ( $\overline{CS}$ GOES LOW)		STAA	\$63	STORE LSBs IN \$63
	LDA	\$50	LOAD DIN INTO ACC A FROM \$50		JMP	LOOP	START NEXT CONVERSION
	STAA	\$102A	LOAD DIN INTO SPI, START SCK				
	LDA	\$1029	CHECK SPI STATUS REG				
WAIT1	BPL	WAIT1	CHECK IF TRANSFER IS DONE				
	LDA	\$51	LOAD DIN INTO ACC A FROM \$51				

### Hardware and Software Interface to Intel 8051

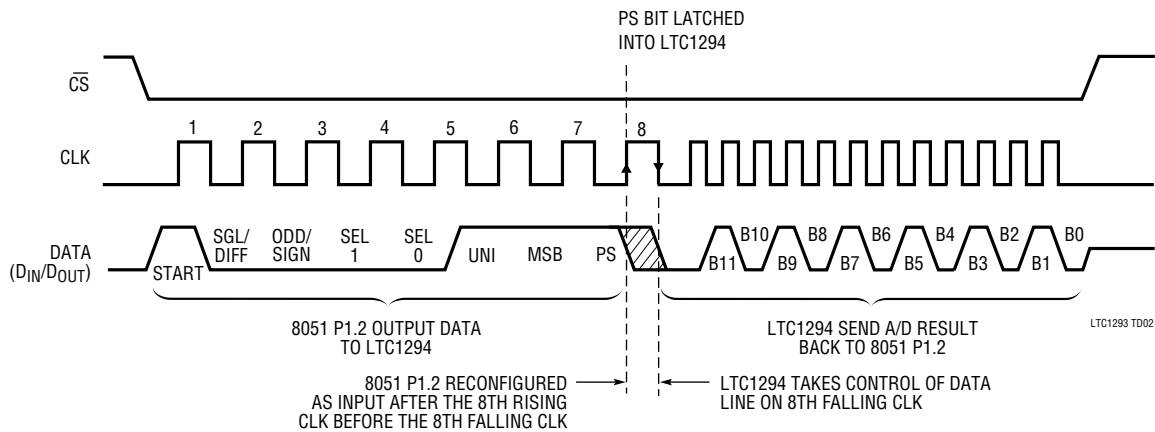

### Hardware and Software Interface to Intel 8051

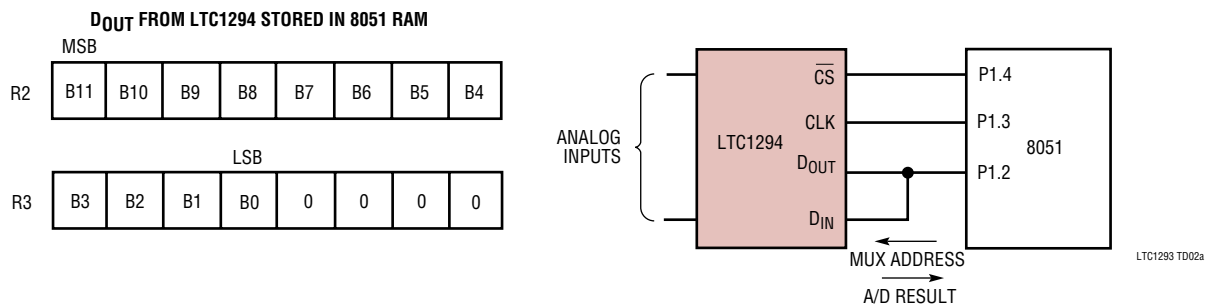



## APPLICATIONS INFORMATION

## 8051 CODE

LABEL	MNEMONIC	OPERAND	COMMENTS	LABEL	MNEMONIC	OPERAND	COMMENTS
CONT	SETB	P1.4	$\overline{CS}$ GOES HIGH		CLR	P1.3	CLK GOES LOW
	MOV	A,#87H	DIN WORD FOR LTC1294		CLR	A	CLEAR ACC
	CLR	P1.4	$\overline{CS}$ GOES LOW		RLC	A	ROTATE DATA BIT (B3) INTO ACC
LOOP1	MOV	R4,#08H	LOAD COUNTER		MOV	C,P1.2	READ DATA BIT INTO CARRY
	RLC	A	ROTATE DIN BIT INTO CARRY		RLC	A	ROTATE DATA BIT (B2) INTO ACC
	CLR	P1.3	CLK GOES LOW		SETB	P1.3	CLK GOES HIGH
	MOV	P1.2,C	OUTPUT DIN BIT TO LTC1294		CLR	P1.3	CLK GOES LOW
	SETB	P1.3	CLK GOES HIGH		MOV	C,P1.2	READ DATA BIT INTO CARRY
LOOP	DJNZ	R4,LOOP1	NEXT DIN BIT		RLC	A	ROTATE DATA BIT (B1) INTO ACC
	MOV	P1,#04H	P1.2 BECOMES AN INPUT		SETB	P1.3	CLK GOES HIGH
	CLR	P1.3	CLK GOES LOW		CLR	P1.3	CLK GOES LOW
	MOV	R4,#09H	LOAD COUNTER		MOV	C,P1.2	READ DATA BIT INTO CARRY
	MOV	C,P1.2	READ DATA BIT INTO CARRY		SETB	P1.4	$\overline{CS}$ GOES HIGH
	RLC	A	ROTATE DATA BIT (B3) INTO ACC		RRC	A	ROTATE DATA BIT (B0) INTO ACC
	SETB	P1.3	CLK GOES HIGH		RRC	A	ROTATE RIGHT INTO ACC
	CLR	P1.3	CLK GOES LOW		RRC	A	ROTATE RIGHT INTO ACC
	DJNZ	R4,LOOP	NEXT DOUT BIT		RRC	A	ROTATE RIGHT INTO ACC
	MOV	R2,A	STORE MSBs IN R2		MOV	R3,A	STORE LSBs IN R3
MOV	C,P1.2	READ DATA BIT INTO CARRY		AJMP	CONT	START NEXT CONVERSION	
SETB	P1.3	CLK GOES HIGH					

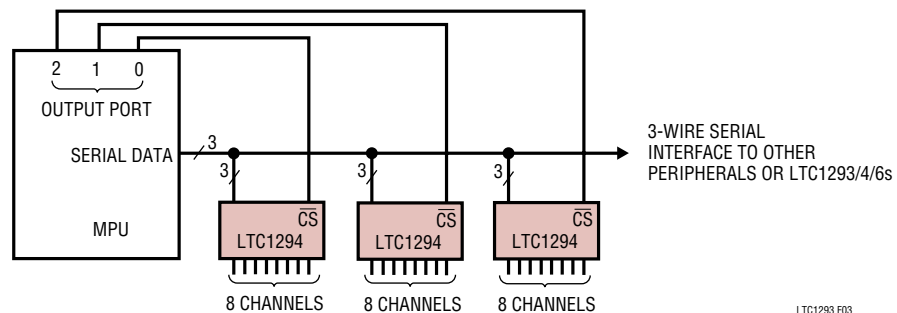

Figure 3. Several LTC1294 Sharing One 3-Wire Serial Interface

## Sharing the Serial Interface

The LTC1293/4/6 can share the same 3-wire serial interface with other peripheral components or other LTC1293/4/6's (Figure 3). Now, the  $\overline{CS}$  signals decide which LTC1293/4/6 is being addressed by the MPU.

## ANALOG CONSIDERATIONS

## Grounding

The LTC1293/4/6 should be used with an analog ground plane and single point grounding techniques. Do not use wire wrapping techniques to breadboard and evaluate the

device. To achieve the optimum performance use a PC board. The analog ground pin (AGND) should be tied directly to the ground plane with minimum lead length (a low profile socket is fine). The digital ground pin (DGND) also can be tied directly to this ground pin because minimal digital noise is generated within the chip itself.  $V_{CC}$  should be bypassed to the ground plane with a 22 $\mu$ F (minimum value) tantalum with leads as short as possible and as close as possible to the pin. A 0.1 $\mu$ F ceramic disk also should be placed in parallel with the 22 $\mu$ F and again with leads as short as possible and as close to  $V_{CC}$  as possible.  $AV_{CC}$  and  $DV_{CC}$  should be tied together on the

129346fs

## APPLICATIONS INFORMATION

LTC1294. Figure 4 shows an example of an ideal LTC1293/4/6 ground plane design for a two sided board. Of course this much ground plane will not always be possible, but users should strive to get as close to this ideal as possible.

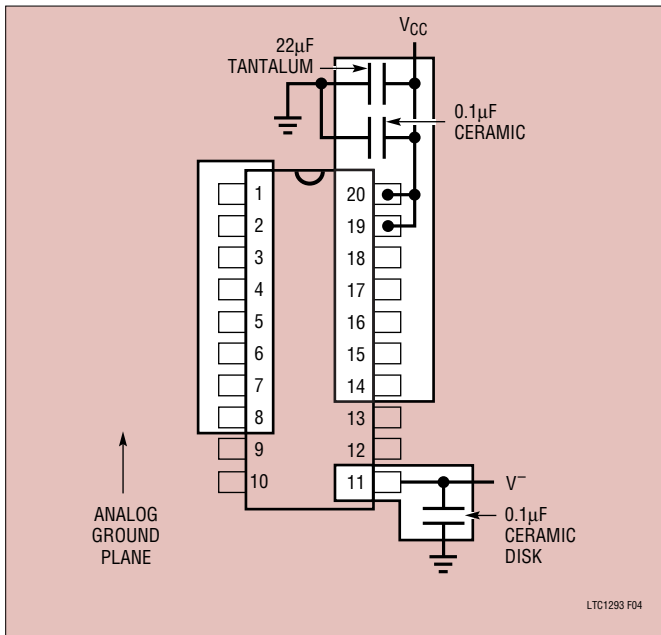

Figure 4. Ground Plane for the LTC1293/4/6

### Bypassing

For good performance,  $V_{CC}$  must be free of noise and ripple. Any changes in the  $V_{CC}$  voltage with respect to ground during a conversion cycle can induce errors or noise in the output code.  $V_{CC}$  noise and ripple can be kept below 0.5mV by bypassing the  $V_{CC}$  pin directly to the analog ground plane with a minimum of 22µF tantalum capacitor and with leads as short as possible. The lead from the device to the  $V_{CC}$  supply also should be kept to a minimum and the  $V_{CC}$  supply should have a low output impedance such as obtained from a voltage regulator (e.g., LT323A). For high frequency bypassing a 0.1µF ceramic disk placed in parallel with the 22µF is recommended. Again the leads should be kept to a minimum. Figure 5 and 6 show the effects of good and poor  $V_{CC}$  bypassing.

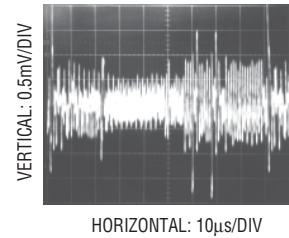

Figure 5. Poor  $V_{CC}$  Bypassing. Noise and Ripple Can Cause A/D Errors.

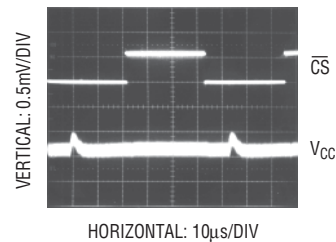

Figure 6. Good  $V_{CC}$  Bypassing Keeps Noise and Ripple on  $V_{CC}$  Below 1mV

### Analog Inputs

Because of the capacitive redistribution A/D conversion techniques used, the analog inputs of the LTC1293/4/6 have capacitive switching input current spikes. These current spikes settle quickly and do not cause a problem. If large source resistances are used or if slow settling op amps drive the inputs, take care to insure the transients caused by the current spikes settle completely before the conversion begins.

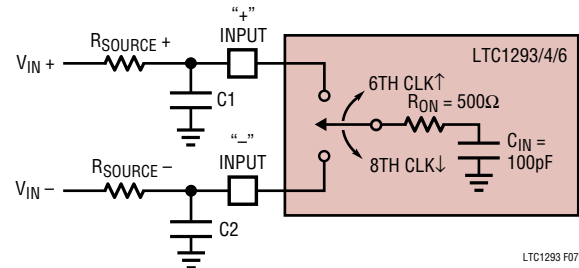

Figure 7. Analog Input Equivalent Circuit

## APPLICATIONS INFORMATION

### Source Resistance

The analog inputs of the LTC1293/4/6 look like a 100pF capacitor ( $C_{IN}$ ) in series with a 500 $\Omega$  resistor ( $R_{ON}$ ).  $C_{IN}$  gets switched between (+) and (-) inputs once during each conversion cycle. Large external source resistors and capacitances will slow the settling of the inputs. It is important that the overall RC time constant is short enough to allow the analog inputs to settle completely within the allowed time.

### “+” Input Settling

The input capacitor is switched onto the “+” input during the sample phase ( $t_{SMPL}$ , see Figure 8). The sample period 2 1/2 CLK cycles before a conversion starts. The voltage on the “+” input must settle completely within the sample period. Minimizing  $R_{SOURCE+}$  and C1 will improve the settling time. If large “+” input source resistance must be used, the sample time can be increased by using a slower CLK frequency. With the minimum possible sample time of 2.5 $\mu$ s  **$R_{SOURCE+} < 1.5k\Omega$  and  $C1 < 20pF$  will provide adequate settling time.**

### “-” Input Settling

At the end of the sample phase the input capacitor switches to the “-” input and the conversion starts (see Figure 8). During the conversion, the “+” input voltage is effectively “held” by the sample and hold and will not affect the conversion result. It is critical that the “-” input voltage be free of noise and settle completely during the first CLK cycle of the conversion. Minimizing  $R_{SOURCE-}$  and C2 will improve settling time. If large “-” input source resistance must be used the time can be extended by using a slower CLK frequency. At the maximum CLK frequency of 1MHz,  **$R_{SOURCE-} < 250\Omega$  and  $C2 < 20pF$  will provide adequate settling.**

### Input Op Amps

When driving the analog inputs with an op amp it is important that the op amp settles within the allowed time (see Figure 8). Again the “+” and “-” input sampling times can be extended as described above to accommodate slower op amps. Most op amps including the LT1006 and LT1013 single supply op amps can be made to settle

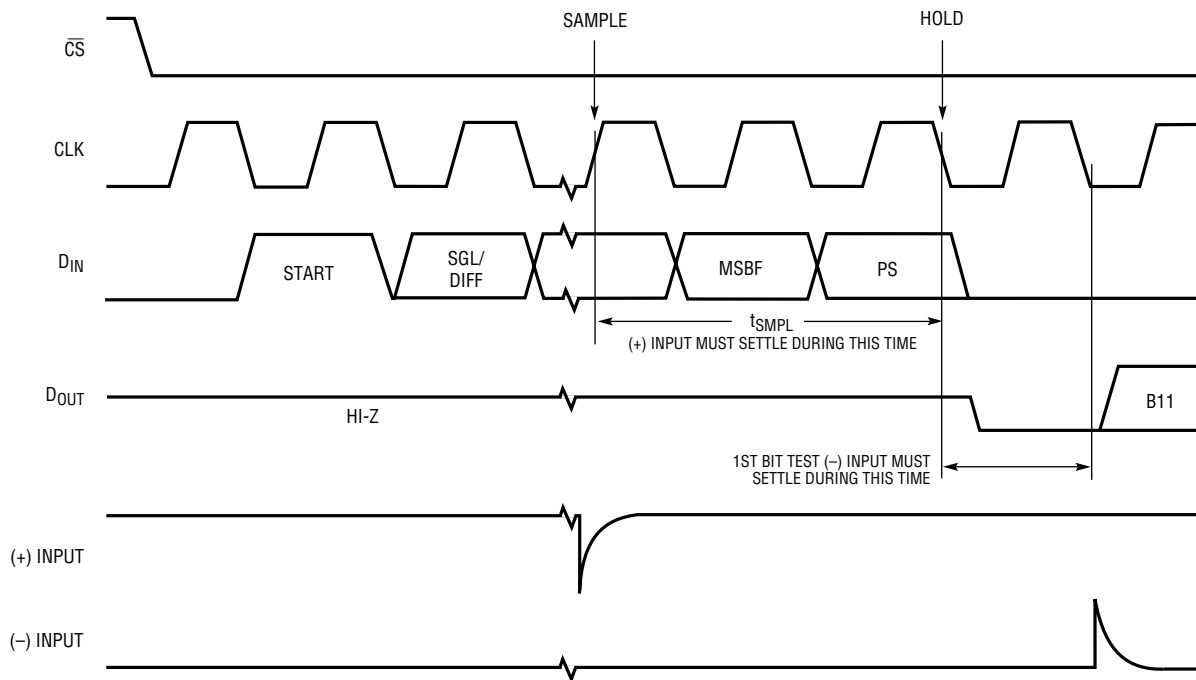

Figure 8. “+” and “-” Input Settling Windows

LTC1293 F08

## APPLICATIONS INFORMATION

within the minimum settling windows of  $2.5\mu\text{s}$  (“+” input) and  $1\mu\text{s}$  (“-” input) that occurs at the maximum clock rate of 1MHz. Figures 9 and 10 show examples of adequate and poor op amp settling.

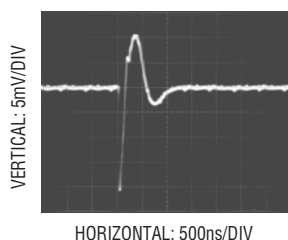

Figure 9. Adequate Settling of Op Amp Driving Analog Input

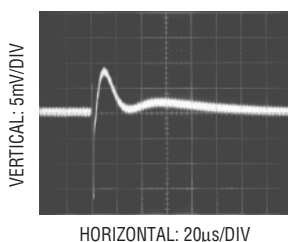

Figure 10. Poor Op Amp Settling Can Cause A/D Errors

### RC Input Filtering

It is possible to filter the inputs with an RC network as shown in Figure 11. For large values of  $C_F$  (e.g.,  $1\mu\text{F}$ ) the capacitive input switching currents are averaged into a net DC current. A filter should be chosen with a small resistor and large capacitor to prevent DC drops across the resistor. The magnitude of the DC current is approximately  $I_{DC} = 100\text{pF} \times V_{IN}/t_{CYC}$  and is roughly proportional to  $V_{IN}$ . When running at the minimum cycle time of  $21.5\mu\text{s}$ , the input current equals  $23\mu\text{A}$  at  $V_{IN} = 5\text{V}$ . Here a filter resistor of  $5\Omega$  will cause 0.1LSB of full-scale error. If a larger filter resistor must be used, errors can be reduced by increasing

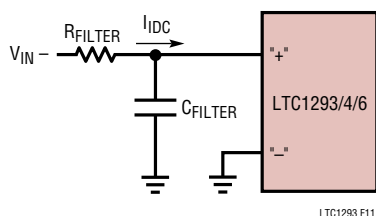

Figure 11. RC Input Filtering

the cycle time as shown in the typical performance characteristic curve Maximum Filter Resistor vs Cycle Time.

### Input Leakage Current

Input leakage currents also can create errors if the source resistance gets too large. For example, the maximum input leakage specification of  $1\mu\text{A}$  (at  $125^\circ\text{C}$ ) flowing through a source resistance of  $1\text{k}\Omega$  will cause a voltage drop of 1mV or 0.8LSB. This error will be much reduced at lower temperatures because leakage drops rapidly (see typical performance characteristic curve Input Channel Leakage Current vs Temperature).

## SAMPLE AND HOLD

### Single-Ended Input

The LTC1293/4/6 provides a built-in sample and hold (S&H) function for all signals acquired in the single-ended mode (COM pin grounded). The sample and hold allows the LTC1293/4/6 to convert rapidly varying signals (see typical performance characteristic curve of S&H Acquisition Time vs Source Resistance). The input voltage is sampled during the  $t_{SMPL}$  time as shown in Figure 8. The sampling interval begins as the bit preceding the MSBF bit is shifted in and continues until the falling edge of the PS bit is received. On this falling edge the S&H goes into the hold mode and the conversion begins.

### Differential Input

With a differential input the A/D no longer converts a single voltage but converts the difference between two voltages. The voltage on the selected “+” input is sampled and held and can be rapidly time varying. The voltage on the “-” pin must remain constant and be free of noise and ripple throughout the conversion time. Otherwise the differencing operation will not be done accurately. The conversion time is 12 CLK cycles. Therefore a change in the  $-IN$  input voltage during this interval can cause conversion errors. For a sinusoidal voltage on the  $-IN$  input this error would be:

$$V_{\text{ERROR(MAX)}} = (2\pi f_{(-)} V_{\text{PEAK}}) \left( \frac{12}{f_{\text{CLK}}} \right)$$

Where  $f_{(-)}$  is the frequency of the “-” input voltage,  $V_{\text{PEAK}}$  is its peak amplitude and  $f_{\text{CLK}}$  is the frequency of the CLK.

129346fs

## APPLICATIONS INFORMATION

Usually  $V_{\text{ERROR}}$  will not be significant. For a 60Hz signal on the “-” input to generate a 0.25LSB error ( $300\mu\text{V}$ ) with the converter running at  $\text{CLK} = 1\text{MHz}$ , its peak value would have to be 66mV. Rearranging the above equation the maximum sinusoidal signal that can be digitized to a given accuracy is given as:

$$f_{(-)\text{MAX}} = \left( \frac{V_{\text{ERROR(MAX)}}}{2\pi V_{\text{PEAK}}} \right) \left( \frac{f_{\text{CLK}}}{12} \right)$$

For 0.25LSB error ( $300\mu\text{V}$ ) the maximum input sinusoid with a 5V peak amplitude that can be digitized is 0.8Hz.

**Unused inputs should be tied to the ground plane.**

### Reference Input

The voltage on the reference input of the LTC1293/4/6 determines the voltage span of the A/D converter. The reference input has transient capacitive switching currents due to the switched capacitor conversion technique (see Figure 12). During each bit test of the conversion (every CLK cycle) a capacitive current spike will be generated on the reference pin by the A/D. These current spikes settle quickly and do not cause a problem. If slow settling circuitry is used to drive the reference input, take care to insure that transients caused by these current spikes settle completely during each bit test of the conversion.

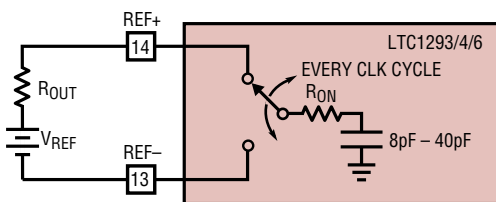

Figure 12. Reference Input Equivalent Circuit

Figure 13 and 14 show examples of both adequate and poor settling. Using a slower CLK will allow more time for the reference to settle. Even at the maximum CLK rate of 1MHz most references and op amps can be made to settle within the  $1\mu\text{s}$  bit time. For example the LT1027 will settle adequately or with a  $10\mu\text{F}$  bypass capacitor at  $V_{\text{REF}}$  the LT1021 also can be used.

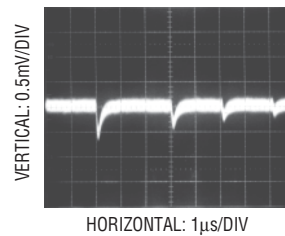

Figure 13. Adequate Reference Settling (LT1027)

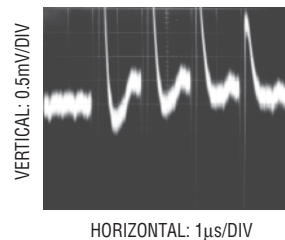

Figure 14. Poor Reference Settling Can Cause A/D Errors

### Reduced Reference Operation

The effective resolution of the LTC1293/4/6 can be increased by reducing the input span of the converter. The LTC1293/4/6 exhibits good linearity over a range of reference voltages (see typical performance characteristics curves of Change in Linearity vs Reference Voltage and Change in Gain Error vs Reference Voltage). Care must be taken when operating at low values of  $V_{\text{REF}}$  because of the reduced LSB step size and the resulting higher accuracy requirement placed on the converter. Offset and Noise are factors that must be considered when operating at low  $V_{\text{REF}}$  values. For the LTC1293  $\text{REF}^-$  has been tied to the AGND pin. Any voltage drop from the AGND pin to the ground plane will cause a gain error.

### Offset with Reduced $V_{\text{REF}}$

The offset of the LTC1293/4/6 has a larger effect on the output code when the A/D is operated with a reduced reference voltage. The offset (which is typically a fixed voltage) becomes a larger fraction of an LSB as the size of the LSB is reduced. The typical performance characteristic curve of Unadjusted Offset Error vs Reference Voltage shows how offset in LSB's is related to reference voltage for a typical value of  $V_{\text{OS}}$ . For example a  $V_{\text{OS}}$  of 0.1mV, which is 0.1LSB with a 5V reference becomes 0.4LSB with

## APPLICATIONS INFORMATION

a 1.25 reference. If this offset is unacceptable, it can be corrected digitally by the receiving system or by offsetting the “-” input to the LTC1293/4/6.

### Noise with Reduced $V_{REF}$

The total input referred noise of the LTC1293/4/6 can be reduced to approximately 200 $\mu$ V peak-to-peak using a ground plane, good bypassing, good layout techniques and minimizing noise on the reference inputs. This noise is insignificant with a 5V reference input but will become a larger fraction of an LSB as the size of the LSB is reduced. The typical performance characteristic curve of Noise Error vs Reference Voltage shows the LSB contribution of this 200 $\mu$ V of noise.

For operation with a 5V reference, the 200 $\mu$ V noise is only 0.16LSB peak-to-peak. Here the LTC1293/4/6 noise will contribute virtually no uncertainty to the output code. For reduced references, the noise may become a significant fraction of an LSB and cause undesirable jitter in the output code. For example, with a 1.25V reference, this 200 $\mu$ V noise is 0.64LSB peak-to-peak. This will reduce the range of input voltages over which a stable output code can be achieved by 0.64LSB. Now averaging readings may be necessary.

This noise data was taken in a very clean test fixture. Any setup induced noise (noise or ripple on  $V_{CC}$ ,  $V_{REF}$  or  $V_{IN}$ ) will add to the internal noise. The lower the reference voltage used, the more critical it becomes to have a noise-free setup.

### Gain Error due to Reduced $V_{REF}$

The gain error of the LTC1294/6 is very good over a wide range of reference voltages. The error component that is seen in the typical performance characteristics curve Change in Gain Error vs Reference Voltage for the LTC1293 is due the voltage drop on the AGND pin from the device to the ground plane. To minimize this error the LTC1293 should be soldered directly onto the PC board. The internal reference point for  $V_{REF}$  is tied to AGND. Any voltage drop in the AGND pin will make the reference voltage, internal to the device, less than what is applied externally (Figure 15). This drop is typically 400 $\mu$ V due to the product of the pin resistance ( $R_{PIN}$ ) and the LTC1293 supply current. For

example, with  $V_{REF} = 1.25V$  this will result in a gain error change of  $-1.0LSB$  from the gain error measured with  $V_{REF} = 5V$ .

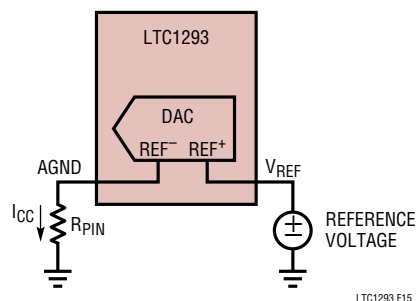

Figure 15. Parasitic Pin Resistance ( $R_{PIN}$ )

### LTC1293/4/6 AC Characteristics

Two commonly used figures of merit for specifying the dynamic performance of the A/Ds in digital signal processing applications are the Signal-to-Noise Ratio (SNR) and the “effective number of bits” (ENOB). SNR is the ratio of the RMS magnitude of the fundamental to the RMS magnitude of all the non-fundamental signals up to the Nyquist frequency (half the sampling frequency). The theoretical maximum SNR for a sine wave input is given by:

$$SNR = (6.02N + 1.76dB)$$

where N is the number of bits. Thus the SNR depends on the resolution of the A/D. For an ideal 12-bit A/D the SNR is equal to 74dB. A Fast Fourier Transform (FFT) plot of the output spectrum of the LTC1294 is shown in Figures 16a and 16b. The input ( $f_{IN}$ ) frequencies are 1kHz and 22kHz with the sampling frequency ( $f_S$ ) at 45.4kHz. The SNR obtained from the plot are 72.7dB and 72.5dB.

Rewriting the SNR expression it is possible to obtain the equivalent resolution based on the SNR measurement.

$$N = \left( \frac{SNR - 1.76dB}{6.02} \right)$$

This is the so-called effective number of bits (ENOB). For the example shown in Figures 16a and 16b,  $N = 11.8$  bits. Figure 17 shows a plot of ENOB as a function of input frequency. The top curve shows the A/D’s ENOB remains at 11.8 for input frequencies up to  $f_S/2$  with  $\pm 5V$  supplies.

## APPLICATIONS INFORMATION

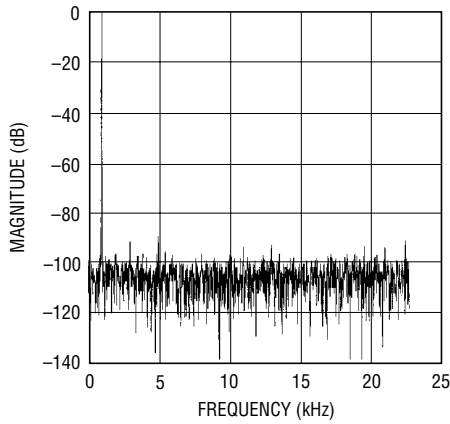

**Figure 16a. LTC1294 FFT Plot**  
 $f_{IN} = 1\text{kHz}$ ,  $f_S = 45.4\text{kHz}$ ,  
 SNR = 72.7dB with  $\pm 5\text{V}$  Supplies

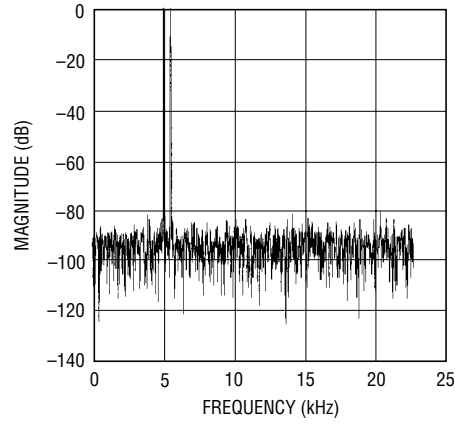

**Figure 18. LTC1294 FFT Plot**  
 $f_{IN1} = 5.1\text{kHz}$ ,  $f_{IN2} = 5.6\text{kHz}$ ,  $f_S = 45.4\text{kHz}$   
 with  $\pm 5\text{V}$  Supplies

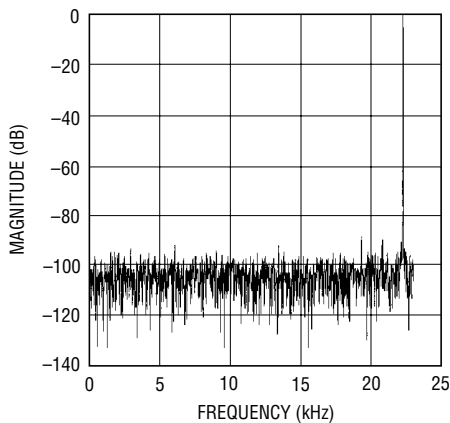

**Figure 16b. LTC1294 FFT Plot**  
 $f_{IN} = 22\text{kHz}$ ,  $f_S = 45.4\text{kHz}$ ,  
 SNR = 72.5dB with  $\pm 5\text{V}$  Supplies

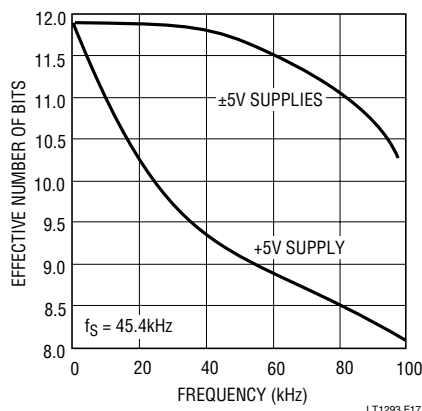

**Figure 17. LTC1294 ENOB vs Input Frequency**

For +5V supplies the ENOB decreases more rapidly. This is due predominantly to the 2nd harmonic distortion term.

Figure 18 shows a FFT plot of the output spectrum for two tones applied to the input of the A/D. Nonlinearities in the A/D will cause distortion products at the sum and difference frequencies of the fundamentals and products of the fundamentals. This is classically referred to as intermodulation distortion (IMD).

### Overvoltage Protection

Applying signals to the LTC1293/4/6's analog inputs that exceed the positive supply or that go below  $V^-$  will degrade the accuracy of the A/D and possibly damage the device. For example this condition would occur if a signal is applied to the analog inputs before power is applied to the LTC1293/4/6. Another example is the input source is operating from different supplies of larger value than the LTC1293/4/6. These conditions should be prevented either with proper supply sequencing or by use of external circuitry to clamp or current limit the input source. There are two ways to protect the inputs. In Figure 19 diode clamps from the inputs to  $V_{CC}$  and  $V^-$  are used. The second method is to put resistors in series with the analog inputs for current limiting. As shown in Figure 20a, a  $1\text{k}\Omega$  resistor is enough to stand off  $\pm 15\text{V}$  (15mA for only one channel). If more than one channel exceeds the supplies than the following guidelines can be used. Limit the current to 7mA per channel and 28mA for all channels.

## APPLICATIONS INFORMATION

This means four channels can handle 7mA of input current each. Reducing CLK frequency from a maximum of 1MHz (See typical performance characteristics curves Maximum CLK Frequency vs Source Resistance and Sample and Hold Acquisition Time vs Source Resistance) allows the use of larger current limiting resistors. The “+” input can accept a resistor value of 1kΩ but the “-” input cannot accept more than 250Ω when the maximum clock frequency of 1MHz is used. If the LTC1293/4/6 is clocked at the maximum clock frequency and 250Ω is not enough to current limit the “-” input source then the clamp diodes are recommended (Figures 20a and 20b). The reason for the limit on the resistor value is the MSB bit test is affected by the value of the resistor placed at the “-” input (see discussion on Analog Inputs and the typical performance characteristics curve Maximum CLK Frequency vs Source Resistance).

If  $V_{CC}$  and  $V_{REF}$  are not tied together, then  $V_{CC}$  should be turned on first, then  $V_{REF}$ . If this sequence cannot be met connecting a diode from  $V_{REF}$  to  $V_{CC}$  is recommended (see Figure 21).

For dual supplies (bipolar mode) placing two Schottky diodes from  $V_{CC}$  and  $V^-$  to ground (Figure 22) will prevent

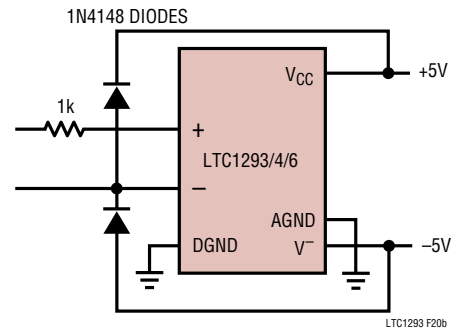

Figure 20b. Overvoltage Protection for Inputs

power supply reversal from occurring when an input source is applied to the analog MUX before power is applied to the device. Power supply reversal occurs, for example, if the input is pulled below  $V^-$ .  $V_{CC}$  will then pull a diode drop below ground which could cause the device not to power up properly. Likewise, if the input is pulled above  $V_{CC}$ ,  $V^-$  will be pulled a diode drop above ground. If no inputs are present on the MUX, the Schottky diodes are not required if  $V^-$  is applied first then  $V_{CC}$ .

Because a unique input protection structure is used on the digital input pins, the signal levels on these pins can exceed the device  $V_{CC}$  without damaging the device.

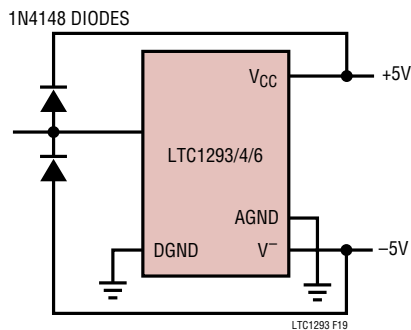

Figure 19. Overvoltage Protection for Inputs

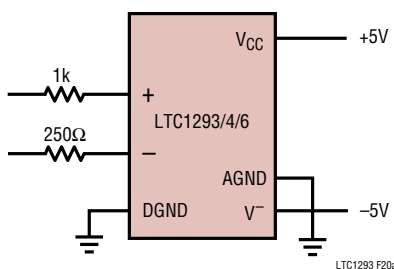

Figure 20a. Overvoltage Protection for Inputs

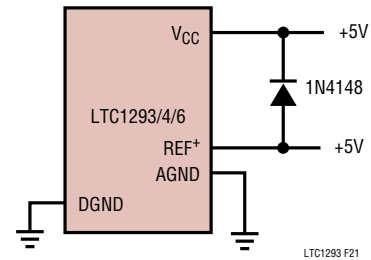

Figure 21

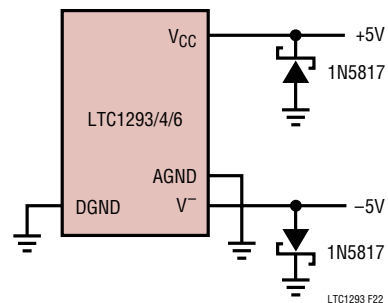

Figure 22. Power Supply Reversal







**PACKAGE DESCRIPTION** Dimensions in inches (millimeters) unless otherwise noted.

**J Package  
20-Lead Ceramic DIP**

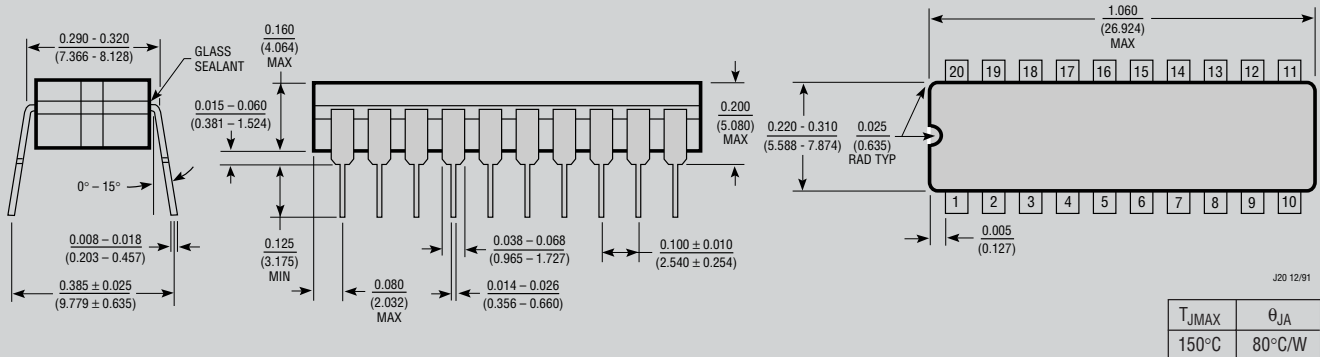

**OBSOLETE PACKAGE**

**N Package  
16-Lead Plastic DIP**

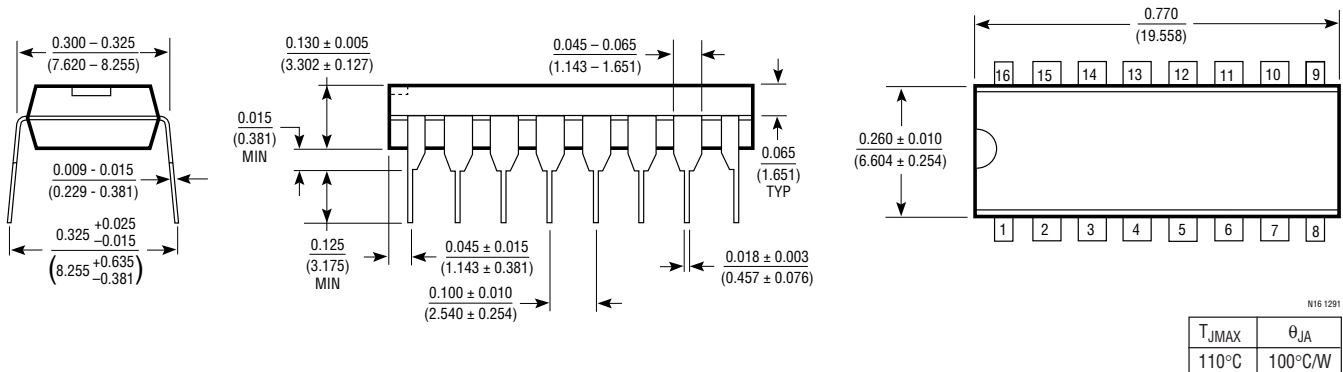

**N Package  
20-Lead Plastic DIP**

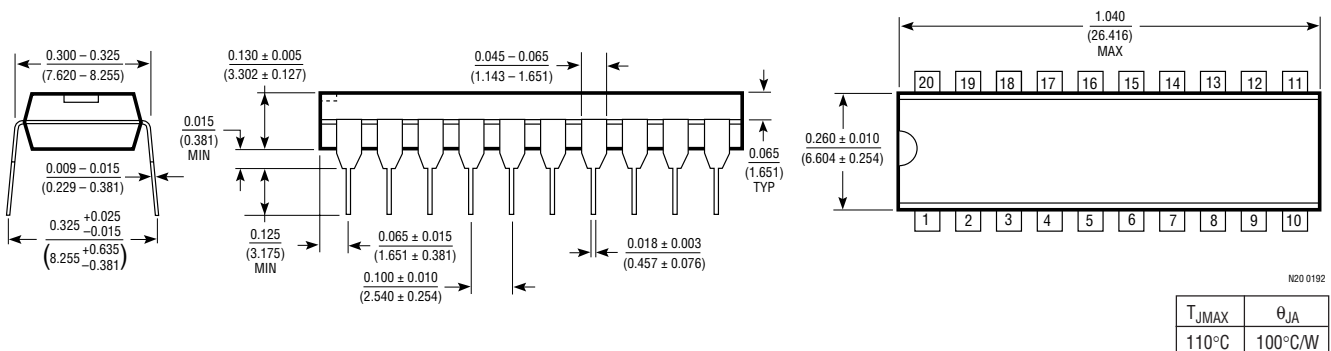

**PACKAGE DESCRIPTION** Dimensions in inches (millimeters) unless otherwise noted.

**S Package  
16-Lead Plastic SOL**

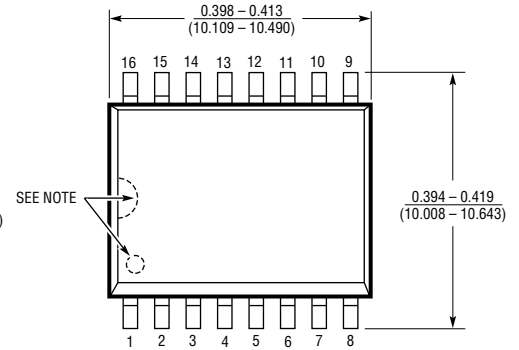
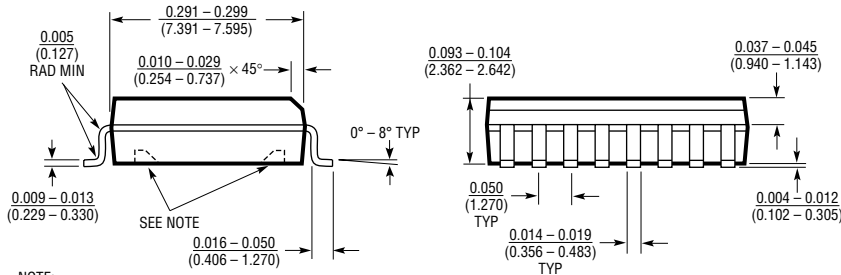

SOL16 12/91

NOTE:  
PIN 1 IDENT, NOTCH ON TOP AND CAVITIES ON THE BOTTOM OF PACKAGES ARE THE MANUFACTURING OPTIONS.  
THE PART MAY BE SUPPLIED WITH OR WITHOUT ANY OF THE OPTIONS.

$T_{JMAX}$	$\theta_{JA}$
110°C	150°C/W

**S Package  
20-Lead Plastic SOL**

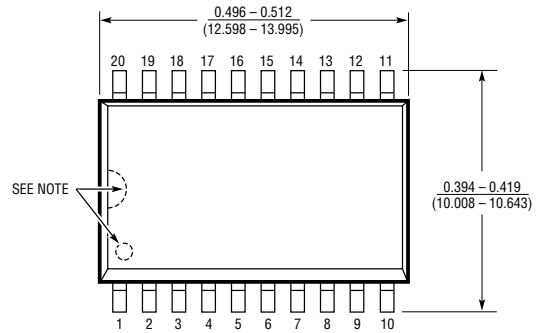
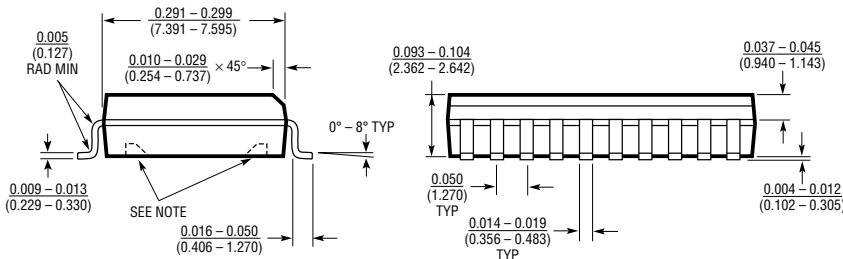

SOL20 12/91

NOTE:  
PIN 1 IDENT, NOTCH ON TOP AND CAVITIES ON THE BOTTOM OF PACKAGES ARE THE MANUFACTURING OPTIONS.  
THE PART MAY BE SUPPLIED WITH OR WITHOUT ANY OF THE OPTIONS.

$T_{JMAX}$	$\theta_{JA}$
110°C	150°C/W