

**FEATURES**

- 24-bit ADC with integrated analog front end
- Fast and flexible output rate: 1.25 SPS to 62.5 kSPS
- Channel scan data rate
  - 12,422 SPS per channel (80  $\mu$ s settling, sinc5 + sinc1)
  - 20,618 SPS per channel (48  $\mu$ s settling, sinc3)
  - 85 dB rejection of 50 Hz and 60 Hz at 20 SPS per channel
- $\pm 10$  V inputs, 6 differential or 11 single-ended
- Pin absolute maximum rating:  $\pm 65$  V
- Absolute input pin voltage up to  $\pm 20$  V
- $\geq 10$  M $\Omega$  impedance
- Low level direct ADC input
  - $\pm$ VREF inputs, 2 differential or 4 single-ended
  - Absolute input pin voltage, AVDD to AVSS
  - True rail-to-rail analog input buffers

- On-chip 2.5 V reference
  - $\pm 0.12\%$  accuracy at 25°C,  $\pm 5$  ppm/°C (typical) drift
- Internal or external clock
- Power supplies
  - AVDD to AVSS = 4.5 V to 5.5 V
  - IOVDD to DGND = 2 V to 5.5 V
  - Total I<sub>DD</sub> (AVDD + IOVDD) = 6.15 mA
- Temperature range:  $-40^\circ\text{C}$  to  $+105^\circ\text{C}$
- 3-wire or 4-wire serial digital interface (Schmitt trigger on SCLK)
  - SPI, QSPI, MICROWIRE, and DSP compatible

**APPLICATIONS**

- Process control
  - PLC and DCS modules
  - Instrumentation and measurement

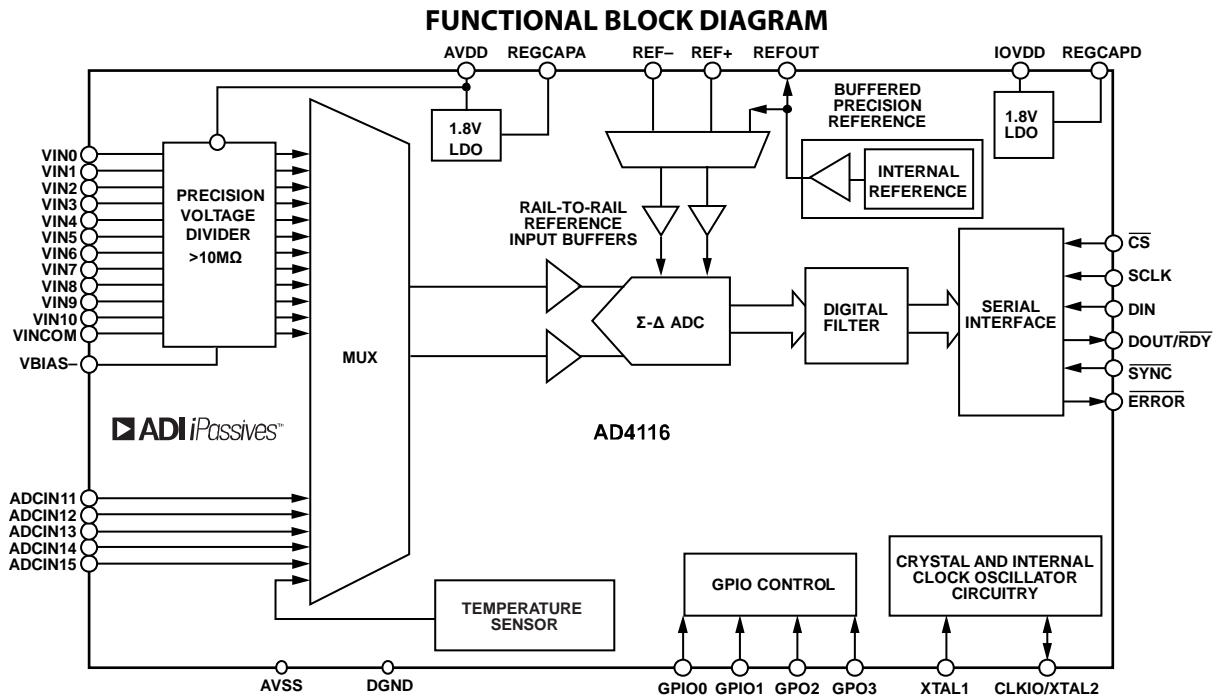

Figure 1.

25501-001

Rev. 0

[Document Feedback](#)

Information furnished by Analog Devices is believed to be accurate and reliable. However, no responsibility is assumed by Analog Devices for its use, nor for any infringements of patents or other rights of third parties that may result from its use. Specifications subject to change without notice. No license is granted by implication or otherwise under any patent or patent rights of Analog Devices. Trademarks and registered trademarks are the property of their respective owners.

One Analog Way, Wilmington, MA 01887, U.S.A.  
 Tel: 781-935-5565      ©2021 Analog Devices, Inc. All rights reserved.  
[Technical Support](#)      [www.analog.com](http://www.analog.com)

## TABLE OF CONTENTS

|   |    |  |    |
|---|----|--|----|
| Features .....                                    | 1  | Calibration .....  | 39 |
| Applications .....                                | 1  | Digital Interface .....  | 40 |
| Functional Block Diagram .....                    | 1  | Checksum Protection .....  | 40 |
| Revision History .....                            | 2  | CRC Calculation.....   | 41 |
| General Description .....                         | 3  | Integrated Functions.....  | 43 |
| Specifications .....                              | 4  | General-Purpose I/O .....  | 43 |
| Timing Characteristics .....                      | 7  | External Multiplexer Control.....  | 43 |
| Absolute Maximum Ratings .....                    | 9  | Delay .....  | 43 |
| Thermal Resistance .....                          | 9  | 16-Bit/24-Bit Conversion.....  | 43 |
| Electrostatic Discharge (ESD) Ratings .....       | 9  | DOUT_RESET .....   | 43 |
| ESD Caution.....                                  | 9  | Synchronization .....  | 43 |
| Pin Configuration and Function Descriptions ..... | 10 | Error Flags.....   | 44 |
| Typical Performance Characteristics.....          | 13 | DATA_STAT .....  | 44 |
| Noise Performance and Resolution .....            | 18 | IOSTRENGTH .....   | 44 |
| Theory of Operation .....                         | 21 | Internal Temperature Sensor .....  | 45 |
| Power Supplies.....                               | 22 | Applications Information .....   | 46 |
| Digital Communication .....                       | 22 | Grounding and Layout.....  | 46 |
| AD4116 Reset.....                                 | 22 | Register Summary .....   | 47 |
| Configuration Overview.....                       | 24 | Register Details .....   | 49 |
| Circuit Description.....                          | 27 | Communications Register .....  | 49 |
| Multiplexer .....                                 | 27 | Status Register.....   | 50 |
| Voltage Inputs.....                               | 28 | ADC Mode Register.....   | 51 |
| Low Level Inputs .....                            | 28 | Interface Mode Register .....  | 52 |
| Absolute Input Pin Voltages.....                  | 28 | Register Check.....  | 53 |
| Data Output Coding .....                          | 29 | Data Register.....   | 53 |
| AD4116 Reference.....                             | 29 | GPIO Configuration Register.....   | 54 |
| Buffered Reference Input .....                    | 30 | ID Register .....  | 55 |
| Clock Source .....                                | 30 | Channel Register 0 to Channel Register 15 .....                          | 55 |
| Digital Filter .....                              | 32 | Setup Configuration Register 0 to Setup Configuration Register 7 .....   | 56 |
| Sinc5 + Sinc1 Filter .....                        | 32 | Filter Configuration Register 0 to Filter Configuration Register 7 ..... | 57 |
| Sinc3 Filter.....                                 | 32 | Offset Register 0 to Offset Register 7.....                              | 58 |
| Single Cycle Settling.....                        | 33 | Gain Register 0 to Gain Register 7 .....                                 | 58 |
| Enhanced 50 Hz and 60 Hz Rejection Filters.....   | 33 | Outline Dimensions.....  | 59 |
| Operating Modes.....                              | 36 | Ordering Guide .....   | 59 |
| Continuous Conversion Mode.....                   | 36 |  |    |
| Continuous Read Mode .....                        | 37 |  |    |
| Single Conversion Mode .....                      | 38 |  |    |
| Standby and Power-Down Modes .....                | 39 |  |    |

## REVISION HISTORY

12/2021—Revision 0: Initial Version

## GENERAL DESCRIPTION

The AD4116 is a low power, low noise, 24-bit,  $\Sigma$ - $\Delta$  analog-to-digital converter (ADC) that integrates an analog front end (AFE) for six fully differential or eleven single-ended, high impedance ( $\geq 10\text{ M}\Omega$ ) bipolar,  $\pm 10\text{ V}$  voltage inputs. The additional two differential or four single-ended/pseudo differential direct ADC inputs provides excellent performance at lower input ranges.

The AD4116 also integrates key analog and digital signal conditioning blocks to configure eight individual setups for each analog input channel in use. As many as 16 channels can be enabled at any time. A channel is defined as any of the standard analog voltage inputs or a low level direct ADC input. The AD4116 features a maximum channel scan rate of 12,422 SPS (80  $\mu\text{s}$ ) using a sinc5 + sinc1 filter and 20,618 SPS per channel (48  $\mu\text{s}$ ) using a sinc3 filter.

The embedded 2.5 V, low drift (5 ppm/ $^{\circ}\text{C}$ ), band gap internal reference (with output reference buffer) reduces the external component count.

The digital filter allows flexible settings, including simultaneous 50 Hz and 60 Hz rejection at a 27.27 SPS output data rate. The user can select between the different filter settings depending on the demands of each channel in the application. The automatic channel sequencer enables the ADC to switch through each enabled channel.

The precision performance of the AD4116 is achieved by integrating the proprietary *i*Passives<sup>®</sup> technology from Analog Devices, Inc.

The AD4116 operates with a single power supply, making it easy to use in galvanically isolated applications. The specified operating temperature range is  $-40^{\circ}\text{C}$  to  $+105^{\circ}\text{C}$ . The AD4116 is housed in a [40-lead, 6 mm  \$\times\$  6 mm LFCSP](#).

## SPECIFICATIONS

Single-supply: AVDD = 4.5 V to 5.5 V, IOVDD = 2 V to 5.5 V, AVSS = 0 V, DGND = 0 V, and VBIAS- = 0 V, unless otherwise noted.

Split-supply: AVDD = 2.5 V, IOVDD = 2 V to 3.6 V, AVSS = -2.5 V, DGND = 0 V, and VBIAS- = AVSS, unless otherwise noted.

Internal reference, internal master clock (MCLK) = 4 MHz, and  $T_A = T_{MIN}$  to  $T_{MAX}$  (-40°C to +105°C), unless otherwise noted.

Table 1.

| Parameter                                     | Test Conditions/Comments   | Min                  | Typ         | Max                  | Unit       |
|---|--|----------------------|-------------|----------------------|------------|
| <b>VOLTAGE INPUTS (VINx)</b>                  |  |                      |             |                      |            |
| Differential Input Voltage Range <sup>1</sup> | Specified performance  | -10                  |             | +10                  | V          |
|   | Functional   | $-V_{REF} \times 10$ |             | $+V_{REF} \times 10$ | V          |
| Absolute (Pin) Input Voltage                  |  | -20                  |             | +20                  | V          |
| Input Impedance                               |  | 10                   |             |                      | MΩ         |
| Offset Error <sup>2</sup>                     | 25°C, 192.5 μs settling  |                      | ±3          |                      | mV         |
| Offset Drift                                  | 192.5 μs settling  |                      | ±30         |                      | μV/°C      |
| Gain Error                                    | 25°C, 192.5 μs settling  |                      | ±0.05       |                      | % of FS    |
| Gain Drift                                    | 192.5 μs settling  |                      | ±5          |                      | ppm/°C     |
| Integral Nonlinearity (INL)                   | 192.5 μs settling  |                      | ±0.02       |                      | % of FSR   |
| Total Unadjusted Error (TUE) <sup>3</sup>     | 96.5 μs settling <sup>4</sup>  |                      |             |                      |            |
|   | 25°C, internal reference   |                      | ±0.1        |                      | % of FSR   |
|   | -40°C to +105°C, internal reference                                    |                      | ±0.2        |                      | % of FSR   |
|   | 192.5 μs settling  |                      |             |                      |            |
|   | 25°C, internal reference   |                      |             | ±0.1                 | % of FSR   |
|   | -40°C to +105°C, internal reference                                    |                      |             | ±0.15                | % of FSR   |
| Power Supply Rejection                        | AVDD for input voltage ( $V_{IN}$ ) = 1 V                              |                      | 70          |                      | dB         |
| Common-Mode Rejection                         | $V_{IN} = 1$ V   |                      |             |                      |            |
| At DC   |  |                      | 80          |                      | dB         |
| At 50 Hz, 60 Hz                               | 20 Hz output data rate (post filter),<br>50 Hz ± 1 Hz and 60 Hz ± 1 Hz |                      | 120         |                      | dB         |
| Normal Mode Rejection <sup>4</sup>            | 50 Hz ± 1 Hz and 60 Hz ± 1 Hz  |                      |             |                      |            |
|   | Internal clock, 20 SPS ODR (post filter)                               | 71                   | 90          |                      | dB         |
|   | External clock, 20 SPS ODR (post filter)                               | 85                   | 90          |                      | dB         |
| Resolution                                    | See Table 7 and Table 8  |                      |             |                      |            |
| Noise   | See Table 7 and Table 8  |                      |             |                      |            |
| <b>LOW LEVEL INPUTS (ADCINx)</b>              |  |                      |             |                      |            |
| Differential Input Voltage Range              | Reference voltage ( $V_{REF}$ ) = (REF+) - (REF-)                      |                      | ± $V_{REF}$ |                      | V          |
| Absolute (Pin) Input Voltage                  |  |                      |             |                      |            |
| Input Buffers Disabled                        |  | AVSS - 0.05          |             | AVDD + 0.05          | V          |
| Input Buffers Enabled                         |  | AVSS                 |             | AVDD                 | V          |
| Analog Input Current                          |  |                      |             |                      |            |
| Input Buffers Disabled                        |  |                      | 12          |                      | μA/V       |
| Input Buffers Enabled                         |  |                      | 2.7         |                      | nA         |
| Offset Error <sup>2</sup>                     |  |                      | ±60         |                      | μV         |
| Offset Drift                                  |  |                      | ±300        |                      | nV/°C      |
| Gain Error                                    | Internal full-scale calibration <sup>5</sup> , 25°C                    |                      | ±0.01       |                      | % of FS    |
| Gain Drift                                    |  |                      | ±5          |                      | ppm/°C     |
| Integral Nonlinearity (INL)                   |  |                      | ±15         |                      | ppm of FSR |
| Total Unadjusted Error (TUE) <sup>3,4</sup>   | Internal calibration   |                      |             |                      |            |
|   | 25°C, internal reference   |                      | 0.03        |                      | % of FSR   |
|   | -40°C to +105°C, internal reference                                    |                      | 0.06        |                      | % of FSR   |
| Power Supply Rejection                        | AVDD for $V_{IN} = 1$ V  |                      | 90          |                      | dB         |
| Common-Mode Rejection                         | $V_{IN} = 0.1$ V   |                      |             |                      |            |
| At DC   |  |                      | 85          |                      | dB         |
| At 50 Hz, 60 Hz                               | 20 Hz output data rate (post filter),<br>50 Hz ± 1 Hz and 60 Hz ± 1 Hz |                      | 120         |                      | dB         |

| Parameter   | Test Conditions/Comments  | Min         | Typ      | Max         | Unit     |
|---|---|-------------|----------|-------------|----------|
| Normal Mode Rejection <sup>4</sup>                        | 50 Hz ± 1 Hz and 60 Hz ± 1 Hz<br>Internal clock, 20 SPS ODR (post filter)<br>External clock, 20 SPS ODR (post filter) | 71<br>85    | 90<br>90 |             | dB<br>dB |
| Resolution  | See Table 9 and Table 10  |             |          |             |          |
| Noise   | See Table 9 and Table 10  |             |          |             |          |
| ADC SPEED AND PERFORMANCE                                 |   |             |          |             |          |
| ADC Output Data Rate (ODR)                                | One channel, see Table 7  | 1.25        |          | 62,500      | SPS      |
| No Missing Codes <sup>4</sup>                             | Excluding sinc3 filter ≥ 31.25 kHz notch  | 24          |          |             | Bits     |
| INTERNAL REFERENCE  | 100 nF external capacitor to AVSS   |             |          |             |          |
| Output Voltage  | REFOUT with respect to AVSS   |             | 2.5      |             | V        |
| Initial Accuracy <sup>4,6</sup>                           | REFOUT, T <sub>A</sub> = 25°C   | -0.12       |          | +0.12       | % of V   |
| Temperature Coefficient                                   |   |             | ±5       | +12         | ppm/°C   |
| Reference Load Current, I <sub>LOAD</sub>                 |   | -10         |          | +10         | mA       |
| Power Supply Rejection                                    | AVDD (line regulation)  |             | 95       |             | dB       |
| Load Regulation   | $\Delta V_{OUT}/\Delta I_{LOAD}$  |             | 32       |             | ppm/mA   |
| Voltage Noise   | e <sub>N</sub> , 0.1 Hz to 10 Hz, 2.5 V reference   |             | 4.5      |             | μV rms   |
| Voltage Noise Density                                     | e <sub>N</sub> , 1 kHz, 2.5 V reference   |             | 215      |             | nV/√Hz   |
| Turn On Settling Time                                     | 100 nF REFOUT capacitor   |             | 200      |             | μs       |
| Short-Circuit Current, I <sub>SC</sub>                    |   |             | 25       |             | mA       |
| EXTERNAL REFERENCE INPUTS                                 |   |             |          |             |          |
| Differential Input Range                                  | V <sub>REF</sub> = (REF+) – (REF-)  | 1           | 2.5      | AVDD        | V        |
| Absolute Voltage Limits                                   |   |             |          |             |          |
| Buffers Disabled  |   | AVSS – 0.05 |          | AVDD + 0.05 | V        |
| Buffers Enabled   |   | AVSS        |          | AVDD        | V        |
| REF± Input Current  |   |             |          |             |          |
| Buffers Disabled  |   |             | ±18      |             | μA/V     |
| Input Current   |   |             | ±1.2     |             | nA/V/°C  |
| Input Current Drift                                       | External clock<br>Internal clock  |             | ±6       |             | nA/V/°C  |
| Buffers Enabled   |   |             |          |             |          |
| Input Current   |   |             | ±400     |             | nA       |
| Input Current Drift                                       |   |             | 0.6      |             | nA/°C    |
| Normal Mode Rejection                                     | See previous normal mode rejection parameters within this table   |             |          |             |          |
| Common-Mode Rejection                                     |   |             | 95       |             | dB       |
| TEMPERATURE SENSOR  |   |             |          |             |          |
| Accuracy  | After user calibration at 25°C  |             | ±2       |             | °C       |
| Sensitivity   |   |             | 477      |             | μV/K     |
| GENERAL-PURPOSE OUTPUTS<br>(GPIO0, GPIO1, GPO2, AND GPO3) | With respect to AVSS  |             |          |             |          |
| Floating State Output Capacitance                         |   |             | 5        |             | pF       |
| Output Voltage <sup>4</sup>                               |   |             |          |             |          |
| High, V <sub>OH</sub>                                     | Source current (I <sub>SOURCE</sub> ) = 200 μA  | AVDD – 1    |          |             | V        |
| Low, V <sub>OL</sub>                                      | Sink current (I <sub>SINK</sub> ) = 800 μA  |             |          | AVSS + 0.4  | V        |
| CLOCK   |   |             |          |             |          |
| Internal Clock  |   |             |          |             |          |
| Frequency   |   |             | 4        |             | MHz      |
| Accuracy  |   | -2.5%       |          | +2.5%       | %        |
| Duty Cycle  |   |             | 50       |             | %        |
| Output Low Voltage, V <sub>OL</sub>                       |   |             |          | 0.4         | V        |
| Output High Voltage, V <sub>OH</sub>                      |   | 0.8 × IOVDD |          |             | V        |

| Parameter                          | Test Conditions/Comments  | Min   | Typ  | Max                               | Unit    |
|------------------------------------|---|---|------|-----------------------------------|---------|
| Crystal                            |   |   |      |                                   |         |
| Frequency                          |   | 14  | 16   | 16.384                            | MHz     |
| Start-Up Time                      |   |   | 10   |                                   | $\mu$ s |
| External Clock (CLKIO)             |   |   | 4    | 4.096                             | MHz     |
| Duty Cycle                         |   | 30  | 50   | 70                                | %       |
| LOGIC INPUTS                       |   |   |      |                                   |         |
| Input Voltage <sup>4</sup>         |   |   |      |                                   |         |
| High, $V_{INH}$                    | $2\text{ V} \leq \text{IOVDD} < 2.3\text{ V}$<br>$2.3\text{ V} \leq \text{IOVDD} \leq 5.5\text{ V}$   | $0.65 \times \text{IOVDD}$<br>$0.7 \times \text{IOVDD}$                             |      |                                   | V       |
| Low, $V_{INL}$                     | $2\text{ V} \leq \text{IOVDD} < 2.3\text{ V}$<br>$2.3\text{ V} \leq \text{IOVDD} \leq 5.5\text{ V}$   |   |      | $0.35 \times \text{IOVDD}$<br>0.7 | V       |
| Hysteresis                         | $\text{IOVDD} \geq 2.7\text{ V}$<br>$\text{IOVDD} < 2.7\text{ V}$   | 0.08<br>0.04  |      | 0.25<br>0.2                       | V       |
| Leakage Current                    |   | -10   |      | +10                               | $\mu$ A |
| LOGIC OUTPUT (DOUT/RDY)            |   |   |      |                                   |         |
| Output Voltage <sup>4</sup>        |   |   |      |                                   |         |
| High, $V_{OH}$                     | $\text{IOVDD} \geq 4.5\text{ V}, I_{\text{SOURCE}} = 1\text{ mA}$<br>$2.7\text{ V} \leq \text{IOVDD} < 4.5\text{ V}, I_{\text{SOURCE}} = 500\text{ }\mu\text{A}$<br>$\text{IOVDD} < 2.7\text{ V}, I_{\text{SOURCE}} = 200\text{ }\mu\text{A}$ | $0.8 \times \text{IOVDD}$<br>$0.8 \times \text{IOVDD}$<br>$0.8 \times \text{IOVDD}$ |      |                                   | V       |
| Low, $V_{OL}$                      | $\text{IOVDD} \geq 4.5\text{ V}, I_{\text{SINK}} = 2\text{ mA}$<br>$2.7\text{ V} \leq \text{IOVDD} < 4.5\text{ V}, I_{\text{SINK}} = 1\text{ mA}$<br>$\text{IOVDD} < 2.7\text{ V}, I_{\text{SINK}} = 400\text{ }\mu\text{A}$                  |   |      | 0.4<br>0.4<br>0.4                 | V       |
| Leakage Current <sup>4</sup>       | Floating state  | -10   |      | +10                               | $\mu$ A |
| Output Capacitance                 | Floating state  |   | 10   |                                   | pF      |
| POWER REQUIREMENTS                 |   |   |      |                                   |         |
| Power Supply Voltage               |   |   |      |                                   |         |
| AVDD to AVSS                       |   | 4.5   |      | 5.5                               | V       |
| AVSS to DGND                       |   | -2.75   |      | 0                                 | V       |
| IOVDD to DGND                      |   | 2   |      | 5.5                               | V       |
| IOVDD to AVSS                      | For AVSS < DGND   |   |      | 6.35                              | V       |
| POWER SUPPLY CURRENTS <sup>7</sup> | All outputs unloaded, digital inputs connected to IOVDD or DGND   |   |      |                                   |         |
| Full Operating Mode                |   |   |      |                                   |         |
| AVDD Current                       | Including internal reference  |   | 5.3  | 6.63                              | mA      |
| IOVDD Current                      | Internal clock  |   | 0.85 | 1.12                              | mA      |
| Standby Mode                       | All $V_{IN} = 0\text{ V}$   |   | 45   |                                   | $\mu$ A |
| Power-Down Mode                    | All $V_{IN} = 0\text{ V}$   |   | 20   |                                   | $\mu$ A |
| POWER DISSIPATION                  |   |   |      |                                   |         |
| Full Operating Mode                |   |   | 31   |                                   | mW      |
| Standby Mode                       |   |   | 223  |                                   | $\mu$ W |
| Power-Down Mode                    |   |   | 100  |                                   | $\mu$ W |

<sup>1</sup> The full specification is guaranteed for a differential input signal of  $\pm 10\text{ V}$ . The device is functional up to a differential input signal of  $\pm V_{\text{REF}} \times 10$ . However, the specified absolute (pin) voltage must not be exceeded for proper function.

<sup>2</sup> Following a system zero-scale calibration, the offset error is in the order of the noise for the programmed output data rate selected. An internal zero-scale calibration at low level inputs reduces the offset error in the order of the noise for the programmed output data rate selected.

<sup>3</sup> To improve performance, use an external reference with better accuracy and lower temperature coefficient.

<sup>4</sup> Specification is not production tested but is supported by characterization data at the initial product release.

<sup>5</sup> Following a system full-scale calibration, the gain error is reduced to the order of the noise for the programmed output data rate.

<sup>6</sup> This specification includes moisture sensitivity level (MSL) preconditioning effects.

<sup>7</sup> This specification is with no load on the REFOUT pin and the digital output pins.

**TIMING CHARACTERISTICS**

IOVDD = 2 V to 5.5 V (single-supply), IOVDD = 2 V to 3.6V (split-supply), Input Logic 0 = 0 V, Input Logic 1 = IOVDD, and capacitive load ( $C_{LOAD}$ ) = 20 pF, unless otherwise noted.

**Table 2.**

| Parameter       | Limit at $T_{MIN}$ , $T_{MAX}$ | Unit   | Description <sup>1, 2</sup>  |
|-----------------|--------------------------------|--------|--|
| SCLK            |                                |        |  |
| $t_3$           | 25                             | ns min | SCLK high pulse width  |
| $t_4$           | 25                             | ns min | SCLK low pulse width   |
| READ OPERATION  |                                |        |  |
| $t_1$           | 0                              | ns min | $\overline{CS}$ falling edge to DOUT/ $\overline{RDY}$ active time       |
|                 | 15                             | ns max | IOVDD = 4.75 V to 5.5 V  |
|                 | 40                             | ns max | IOVDD = 2 V to 3.6 V   |
| $t_2^3$         | 0                              | ns min | SCLK active edge to data valid delay <sup>4</sup>                        |
|                 | 12.5                           | ns max | IOVDD = 4.75 V to 5.5 V  |
|                 | 25                             | ns max | IOVDD = 2 V to 3.6 V   |
| $t_5^5$         | 2.5                            | ns min | Bus relinquish time after $\overline{CS}$ inactive edge                  |
|                 | 20                             | ns max |  |
| $t_6$           | 0                              | ns min | SCLK inactive edge to $\overline{CS}$ inactive edge                      |
| $t_7$           | 10                             | ns min | SCLK inactive edge to DOUT/ $\overline{RDY}$ high/low                    |
| WRITE OPERATION |                                |        |  |
| $t_8$           | 0                              | ns min | $\overline{CS}$ falling edge to SCLK active edge setup time <sup>4</sup> |
| $t_9$           | 8                              | ns min | Data valid to SCLK edge setup time                                       |
| $t_{10}$        | 8                              | ns min | Data valid to SCLK edge hold time  |
| $t_{11}$        | 5                              | ns min | $\overline{CS}$ rising edge to SCLK edge hold time                       |

<sup>1</sup> Sample tested during initial release to ensure compliance.

<sup>2</sup> See Figure 2 and Figure 3.

<sup>3</sup> This parameter is defined as the time required for the output to cross the  $V_{OL}$  or  $V_{OH}$  limits.

<sup>4</sup> The SCLK active edge is the falling edge of SCLK.

<sup>5</sup> DOUT/ $\overline{RDY}$  returns high after a read of the data register. In single conversion mode and continuous conversion mode, the same data can be read again, if required, while DOUT/ $\overline{RDY}$  is high. However, care must be taken to ensure that subsequent reads do not occur close to the next output update. If the continuous read feature is enabled, the digital word can be read only once.

Timing Diagrams

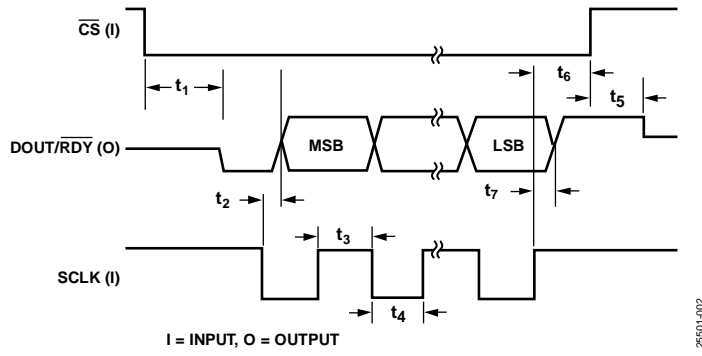

Figure 2. Read Cycle Timing Diagram

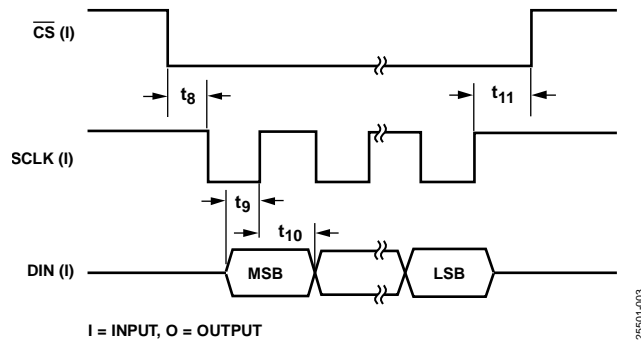

Figure 3. Write Cycle Timing Diagram



## ABSOLUTE MAXIMUM RATINGS

$T_A = 25^\circ\text{C}$ , unless otherwise noted.

Table 3.

| Parameter                       | Rating                  |
|---------------------------------|-------------------------|
| AVDD to AVSS                    | -0.3 V to +6.5 V        |
| AVDD to DGND                    | -0.3 V to +6.5 V        |
| IOVDD to DGND                   | -0.3 V to +6.5 V        |
| IOVDD to AVSS                   | -0.3 V to +7.5 V        |
| AVSS to DGND                    | -3.25 V to +0.3 V       |
| VINx to AVSS                    | -65 V to +65 V          |
| ADCINx to AVSS                  | -0.3 V to AVDD + 0.3 V  |
| Reference Input Voltage to AVSS | -0.3 V to AVDD + 0.3 V  |
| Digital Input Voltage to DGND   | -0.3 V to IOVDD + 0.3 V |
| Digital Output Voltage to DGND  | -0.3 V to IOVDD + 0.3 V |
| Digital Input Current           | 10 mA                   |
| Temperature                     |                         |
| Operating Range                 | -40°C to +105°C         |
| Storage Range                   | -65°C to +150°C         |
| Maximum Junction                | 150°C                   |
| Lead Soldering, Reflow          | 260°C                   |

Stresses at or above those listed under Absolute Maximum Ratings may cause permanent damage to the product. This is a stress rating only; functional operation of the product at these or any other conditions above those indicated in the operational section of this specification is not implied. Operation beyond the maximum operating conditions for extended periods may affect product reliability.

## THERMAL RESISTANCE

Thermal performance is directly linked to printed circuit board (PCB) design and operating environment. Careful attention to PCB thermal design is required.

$\theta_{JA}$  is specified for the worst-case conditions, that is, a device soldered in a circuit board for surface-mount packages.

$\theta_{JC}$  is the thermal resistance from the junction to the package case.

Table 4. Thermal Resistance

| Package Type <sup>1</sup> | $\theta_{JA}$ <sup>2</sup> | $\theta_{JC}$ <sup>3</sup> | Unit |
|---------------------------|----------------------------|----------------------------|------|
| CP-40-15                  | 34                         | 2.63                       | °C/W |

<sup>1</sup> 4-layer JEDEC PCB.

<sup>2</sup> Thermal impedance simulated values are based on JEDEC 252P thermal test PCB with 16 thermal vias.  $\theta_{JA}$  is specified for a device soldered on a JEDEC test PCB for surface-mount packages. See JEDEC JESD-51.

<sup>3</sup> A cold plate is attached to the PCB bottom and measured at the exposed paddle.

## ELECTROSTATIC DISCHARGE (ESD) RATINGS

The following ESD information is provided for handling of ESD-sensitive devices in an ESD protected area only.

Human body model (HBM) per ANSI/ESDA/JEDEC JS-001.

Charged device model (CDM) per ANSI/ESDA/JEDEC JS-002.

### ESD Ratings for AD4116

Table 5. AD4116, 40-Lead LFCSP

| ESD Model | Withstand Threshold (V) | Class |
|-----------|-------------------------|-------|
| HBM       | ±1000                   | 1C    |
| CDM       | ±1250                   | C3    |

## ESD CAUTION



**ESD (electrostatic discharge) sensitive device.** Charged devices and circuit boards can discharge without detection. Although this product features patented or proprietary protection circuitry, damage may occur on devices subjected to high energy ESD. Therefore, proper ESD precautions should be taken to avoid performance degradation or loss of functionality.

## PIN CONFIGURATION AND FUNCTION DESCRIPTIONS

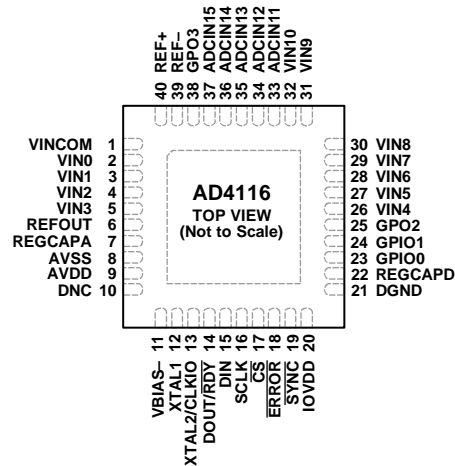

## NOTES

- DO NOT CONNECT. DO NOT CONNECT ANYTHING TO THIS PIN.
- EXPOSED PAD. SOLDER THE EXPOSED PAD TO A SIMILAR PAD ON THE PCB UNDER THE EXPOSED PAD TO CONFER MECHANICAL STRENGTH TO THE PACKAGE AND FOR HEAT DISSIPATION. THE EXPOSED PAD MUST BE CONNECTED TO AVSS THROUGH THIS PAD ON THE PCB.

28501-004

Figure 4. Pin Configuration

Table 6. Pin Function Descriptions

| Pin No. | Mnemonic <sup>1</sup>         | Type <sup>2</sup> | Description  |
|---------|-------------------------------|-------------------|--|
| 1       | VINCOM                        | AI                | Voltage Input Common. Voltage inputs are referenced to the VINCOM pin when configured as single-ended (connect the VINCOM pin to analog ground), or a negative input of an input pair with VIN10 in differential configuration.  |
| 2       | VIN0                          | AI                | Voltage Input 0. Input referenced to VINCOM in single-ended configuration, or a positive input of an input pair with VIN1 in differential configuration.   |
| 3       | VIN1                          | AI                | Voltage Input 1. Input referenced to VINCOM in single-ended configuration, or a negative input of an input pair with VIN0 in differential configuration.   |
| 4       | VIN2                          | AI                | Voltage Input 2. Input referenced to VINCOM in single-ended configuration, or a positive input of an input pair with VIN3 in differential configuration.   |
| 5       | VIN3                          | AI                | Voltage Input 3. Input referenced to VINCOM in single-ended configuration, or a negative input of an input pair with VIN2 in differential configuration.   |
| 6       | REFOUT                        | AO                | Buffered Output of Internal Reference. The output is 2.5 V with respect to AVSS. Decouple the REFOUT pin to AVSS using a 0.1 $\mu$ F capacitor.  |
| 7       | REGCAPA                       | AO                | Analog Low Dropout (LDO) Regulator Output. Decouple the REGCAPA pin to AVSS using a 1 $\mu$ F capacitor and a 0.1 $\mu$ F capacitor.   |
| 8       | AVSS                          | P                 | Negative Analog Supply. This supply ranges from $-2.75$ V to 0 V and is nominally set to 0 V.  |
| 9       | AVDD                          | P                 | Analog Supply Voltage. This voltage ranges from 4.5 V to 5.5 V with respect to AVSS.   |
| 10      | DNC                           | N/A               | Do Not Connect. Do not connect anything to this pin.   |
| 11      | VBIAS-                        | AI                | Voltage Bias Negative. The VBIAS- pin is setting the bias voltage for the voltage input analog front-end. Connect the VBIAS- pin to AVSS.  |
| 12      | XTAL1                         | AI                | Input 1 for Crystal.   |
| 13      | XTAL2/CLKIO                   | AI/DI             | Input 2 for Crystal/Clock Input or Output. See the CLOCKSEL bit settings in the ADCMODE register for more information.   |
| 14      | DOUT/ $\overline{\text{RDY}}$ | DO                | Serial Data Output/Data Ready Output. This pin serves a dual purpose. It functions as a serial data output pin to access the output shift register of the ADC. The output shift register can contain data from any of the on-chip data or control registers. The data-word/control word information is placed on the DOUT/ $\overline{\text{RDY}}$ pin on the SCLK falling edge and is valid on the SCLK rising edge. When $\overline{\text{CS}}$ is high, the DOUT/ $\overline{\text{RDY}}$ output is tristated. When $\overline{\text{CS}}$ is low, and a register is not being read, DOUT/ $\overline{\text{RDY}}$ operates as a data ready pin, going low to indicate the completion of a conversion. If the data is not read after the conversion, the pin goes high before the next update occurs. The DOUT/ $\overline{\text{RDY}}$ falling edge can be used as an interrupt to a processor, indicating that valid data is available. |

| Pin No. | Mnemonic <sup>1</sup>     | Type <sup>2</sup> | Description  |
|---------|---------------------------|-------------------|--|
| 15      | DIN                       | DI                | Serial Data Input to the Input Shift Register on the ADC. Data in this shift register is transferred to the control registers in the ADC, with the register address (RA) bits of the communications register identifying the appropriate register. Data is clocked in on the rising edge of SCLK.  |
| 16      | SCLK                      | DI                | Serial Clock Input. This serial clock input is for data transfers to and from the ADC. SCLK has a Schmitt triggered input.   |
| 17      | $\overline{\text{CS}}$    | DI                | Chip Select Input. The $\overline{\text{CS}}$ pin is an active low logic input used to select the ADC. Use $\overline{\text{CS}}$ to select the ADC in systems with more than one device on the serial bus. $\overline{\text{CS}}$ can be hardwired low, allowing the ADC to operate in 3-wire mode with SCLK, DIN, and DOUT/ $\overline{\text{RDY}}$ used to interface with the device. When $\overline{\text{CS}}$ is high, the DOUT/ $\overline{\text{RDY}}$ output is tristated.   |
| 18      | $\overline{\text{ERROR}}$ | DI/O              | Error Input/Output or General-Purpose Output. The $\overline{\text{ERROR}}$ pin can be used in one of the following three modes:<br>Active low error input mode. This mode sets the ADC_ERROR bit in the status register.<br>Active low, open-drain error output mode. The status register error bits are mapped to the $\overline{\text{ERROR}}$ pin. The $\overline{\text{ERROR}}$ pins of multiple devices can be wired together to a common pull-up resistor so that an error on any device can be observed.<br>General-purpose output mode. The status of the pin is controlled by the ERR_DAT bit in the GPIOCON register. The pin is referenced between IOVDD and DGND. |
| 19      | $\overline{\text{SYNC}}$  | DI                | Synchronization Input. Allows synchronization of the digital filters and analog modulators when using multiple AD4116 devices.   |
| 20      | IOVDD                     | P                 | Digital I/O Supply Voltage. The IOVDD voltage ranges from 2 V to 5.5 V (nominal). IOVDD is independent of AVDD. For example, IOVDD can be operated at 3.3 V when AVDD equals 5 V, or vice versa. If AVSS is set to -2.5 V, the voltage on IOVDD must not exceed 3.6 V.   |
| 21      | DGND                      | P                 | Digital Ground.  |
| 22      | REGCAPD                   | AO                | Digital LDO Regulator Output. The REGCAPD pin is for decoupling purposes only. Decouple the REGCAPD pin to DGND using a 1 $\mu\text{F}$ capacitor.   |
| 23      | GPIO0                     | DI/O              | General-Purpose Input and Output 0. Logic input and output on the GPIO0 pin is referred to the AVDD and AVSS supplies.   |
| 24      | GPIO1                     | DI/O              | General-Purpose Input and Output 1. Logic input and output on the GPIO1 pin is referred to the AVDD and AVSS supplies.   |
| 25      | GPO2                      | DO                | General-Purpose Output 2. Logic output on the GPIO2 pin is referred to the AVDD and AVSS supplies.   |
| 26      | VIN4                      | AI                | Voltage Input 4. Input referenced to VINCOM in single-ended configuration, or a positive input of an input pair with VIN5 in differential configuration.   |
| 27      | VIN5                      | AI                | Voltage Input 5. Input referenced to VINCOM in single ended configuration, or a negative input of an input pair with VIN4 in differential configuration.   |
| 28      | VIN6                      | AI                | Voltage Input 6. Input referenced to VINCOM in single-ended configuration, or a positive input of an input pair with VIN7 in differential configuration.   |
| 29      | VIN7                      | AI                | Voltage Input 7. Input referenced to VINCOM in single-ended configuration, or a negative input of an input pair with VIN6 in differential configuration.   |
| 30      | VIN8                      | AI                | Voltage Input 8. Input referenced to VINCOM in single-ended configuration, or a positive input of an input pair with VIN9 in differential configuration.   |
| 31      | VIN9                      | AI                | Voltage Input 9. Input referenced to VINCOM in single-ended configuration, or a negative input of an input pair with VIN8 in differential configuration.   |
| 32      | VIN10                     | AI                | Voltage Input 10. Input referenced to VINCOM in single-ended configuration, or a positive input of an input pair with VINCOM in differential configuration.  |
| 33      | ADCIN11                   | AI                | Low Level ADC Input 11. Input referenced to ADCIN15 in pseudo differential input, or a positive input of an input pair with ADCIN12 in differential configuration.   |
| 34      | ADCIN12                   | AI                | Low Level ADC Input 12. Input referenced to ADCIN15 in pseudo differential input, or a negative input of an input pair with ADCIN11 in differential configuration.   |
| 35      | ADCIN13                   | AI                | Low Level ADC Input 13. Input referenced to ADCIN15 in pseudo differential input, or a positive input of an input pair with ADCIN14 in differential configuration.   |
| 36      | ADCIN14                   | AI                | Low Level ADC Input 14. Input referenced to ADCIN15 in pseudo differential input, or a negative input of an input pair with ADCIN13 in differential configuration.   |
| 37      | ADCIN15                   | AI                | Low Level ADC Input 15. Low level inputs are referenced to the ADCIN15 pin when configured as pseudo differential input, or a negative input of an input pair with any of the low level input pins in a differential input.  |
| 38      | GPO3                      | DO                | General-Purpose Output 3. Logic output on the GPO3 pin is referred to the AVDD and AVSS supplies.  |

| Pin No. | Mnemonic <sup>1</sup> | Type <sup>2</sup> | Description   |
|---------|-----------------------|-------------------|---|
| 39      | REF–                  | AI                | Reference Input Negative Terminal. REF– can span from AVSS to AVDD – 1 V. Reference can be selected through the REF_SELx bits in the setup configuration registers.   |
| 40      | REF+                  | AI                | Reference Input Positive Terminal. An external reference can be applied between REF+ and REF–. REF+ can span from AVDD to AVSS + 1 V. Reference can be selected through the REF_SELx bits in the setup configuration registers.     |
|         | EP                    | P                 | Exposed Pad. Solder the exposed pad to a similar pad on the PCB under the exposed pad to confer mechanical strength to the package and for heat dissipation. The exposed pad must be connected to AVSS through this pad on the PCB. |

<sup>1</sup> Note that, throughout this data sheet, the dual function pin mnemonics are referenced by the relevant function only.

<sup>2</sup> AI means analog input, AO means analog output, P means power supply, N/A means not applicable, DI means digital input, DO means digital output, and DI/O means bidirectional digital input and output.

### TYPICAL PERFORMANCE CHARACTERISTICS

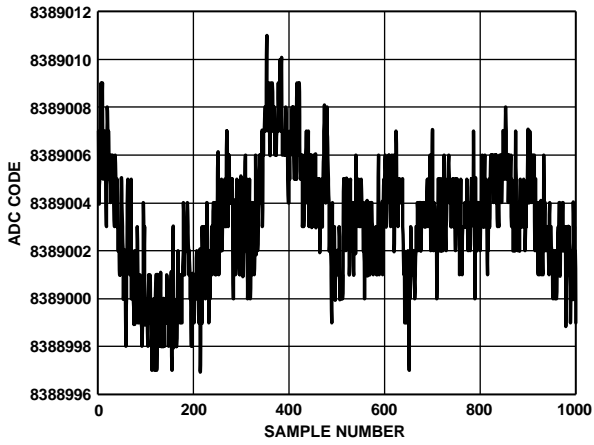

Figure 5. Noise (Voltage Input, Output Data Rate = 1.25 SPS)

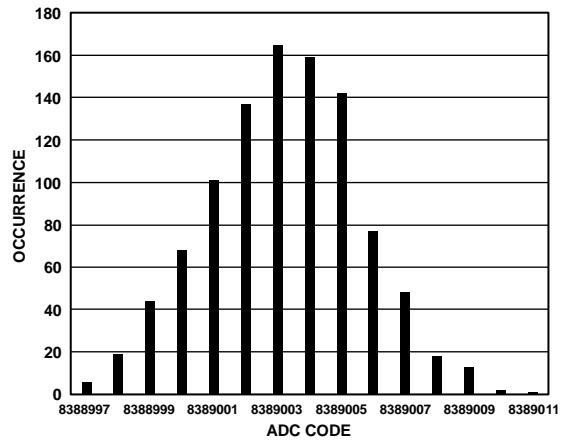

Figure 8. Histogram (Voltage Input, Output Data Rate = 1.25 SPS)

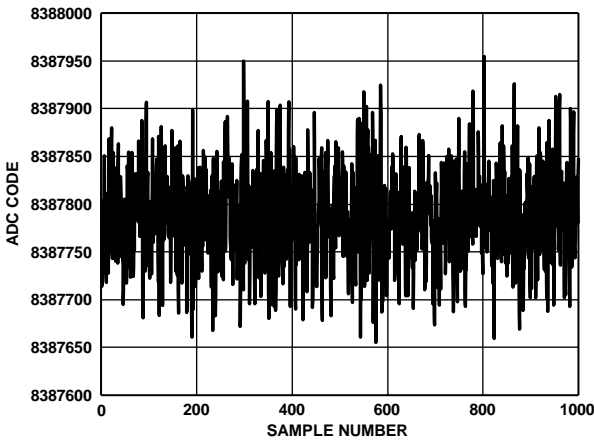

Figure 6. Noise (Voltage Input, Output Data Rate = 5.194 kSPS)

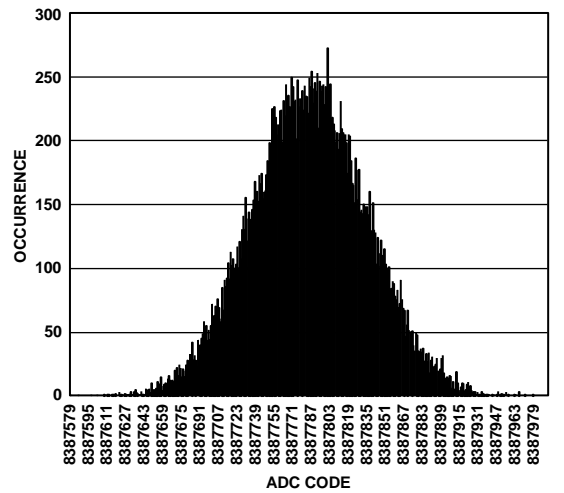

Figure 9. Histogram (Voltage Input, Output Data Rate = 5.194 kSPS)

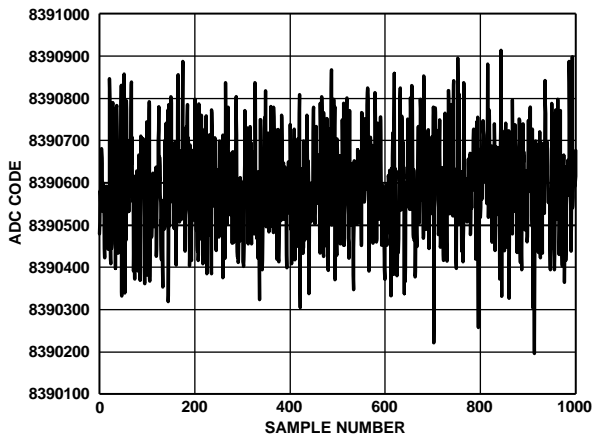

Figure 7. Noise (Voltage Input, Output Data Rate = 62.5 kSPS)

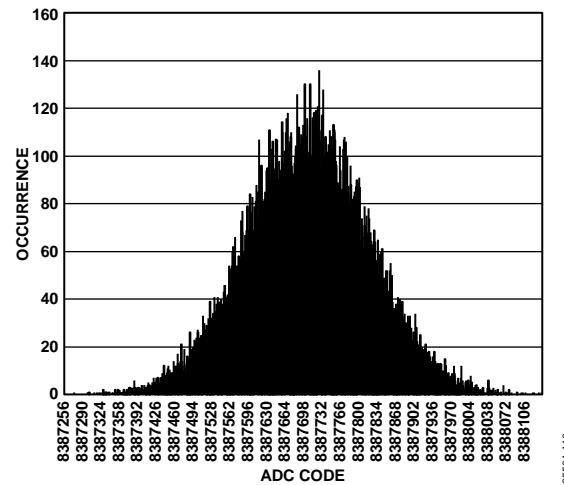

Figure 10. Histogram (Voltage Input, Output Data Rate = 62.5 kSPS)

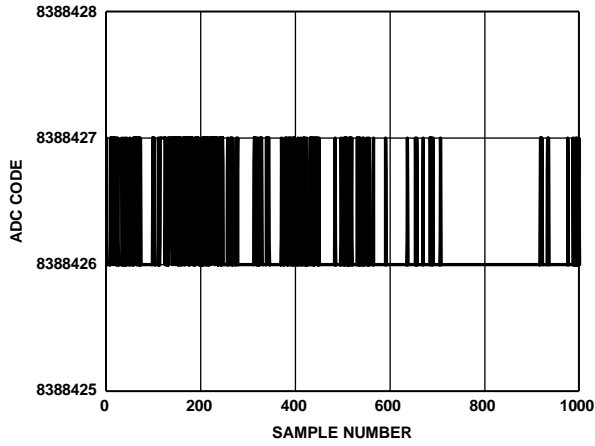

Figure 11. Noise (Low Level Input, Output Data Rate = 1.25 SPS)

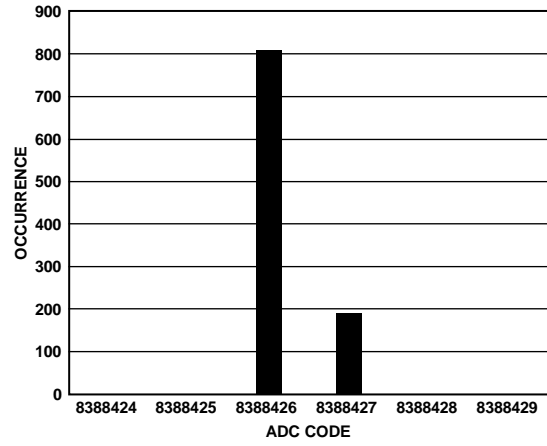

Figure 14. Histogram (Low Level Input, Output Data Rate = 1.25 SPS)

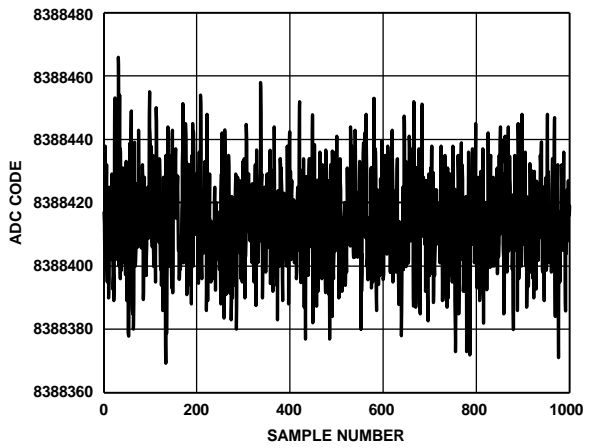

Figure 12. Noise (Low Level Input, Output Data Rate = 5.194 kSPS)

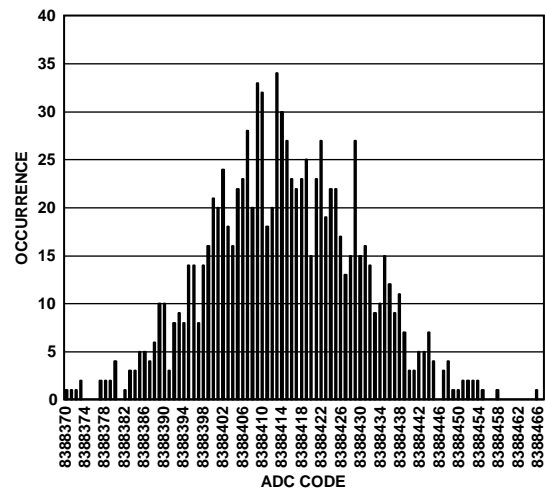

Figure 15. Histogram (Low Level Input, Output Data Rate = 5.194 kSPS)

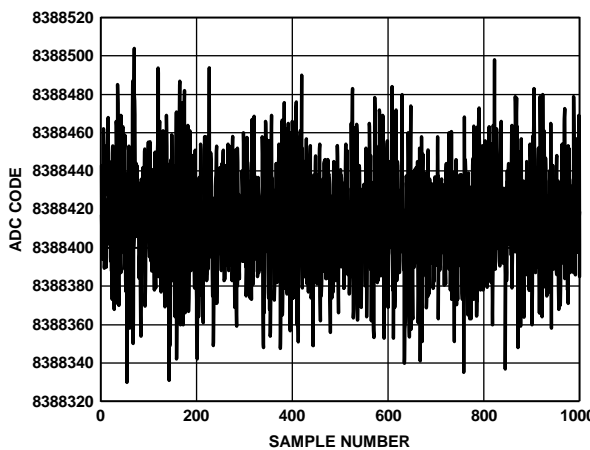

Figure 13. Noise (Low Level Input, Output Data Rate = 62.5 kSPS)

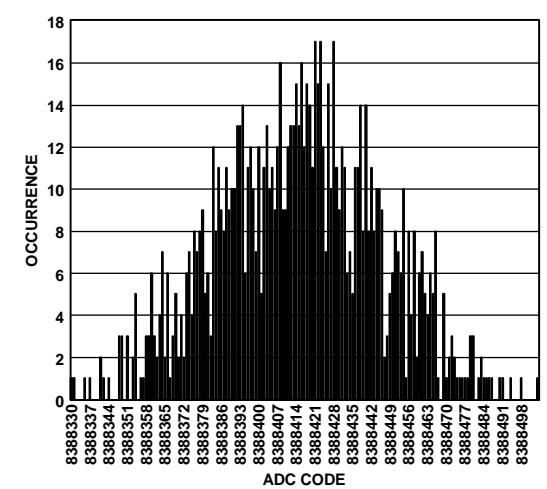

Figure 16. Histogram (Low Level Input, Output Data Rate = 62.5 kSPS)

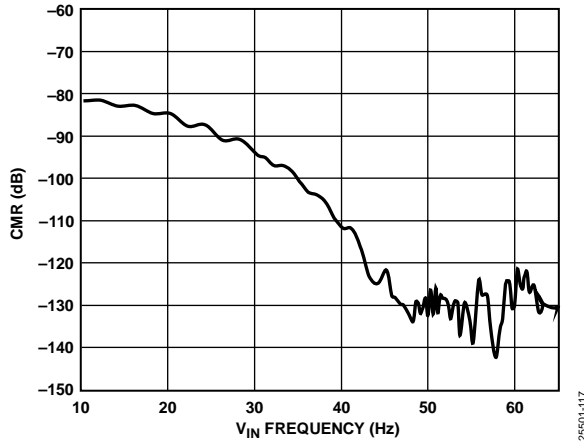

Figure 17. Common-Mode Rejection (CMR) vs.  $V_{IN}$  Frequency ( $V_{IN} = 1\text{ V}$ , 10 Hz to 70 Hz, Output Data Rate = 20 SPS Enhanced Filter)

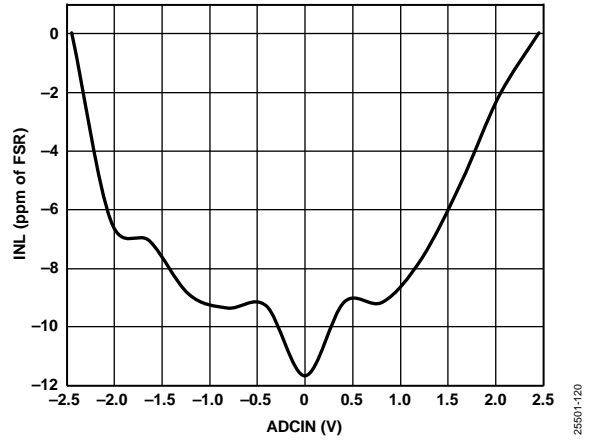

Figure 20. INL vs ADCIN (Low Level Input)

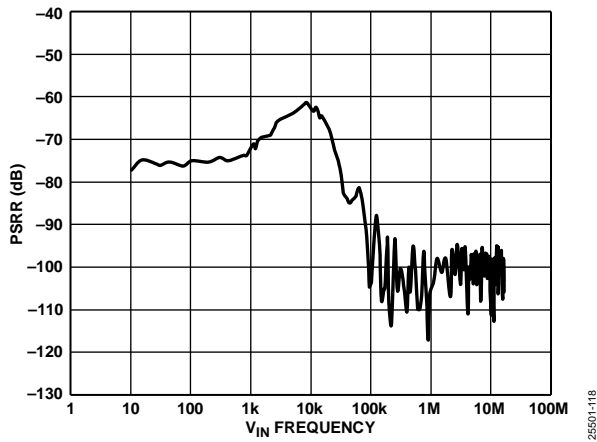

Figure 18. ADC PSRR vs.  $V_{IN}$  Frequency

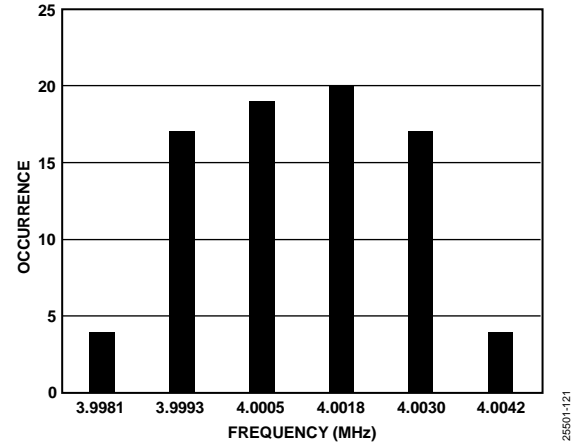

Figure 21. Internal Oscillator Frequency and Accuracy Distribution Histogram

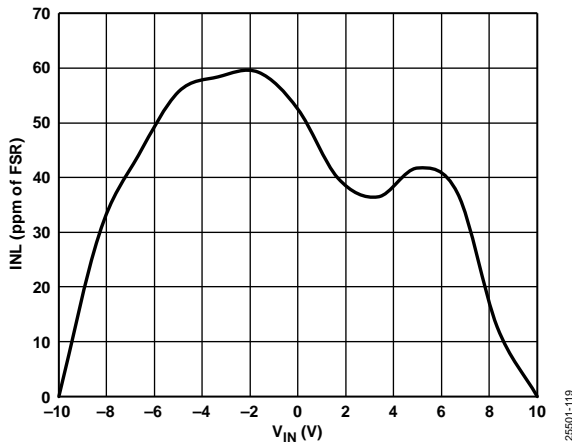

Figure 19. INL vs.  $V_{IN}$  (Voltage Input at 192.5  $\mu\text{s}$  Settling)

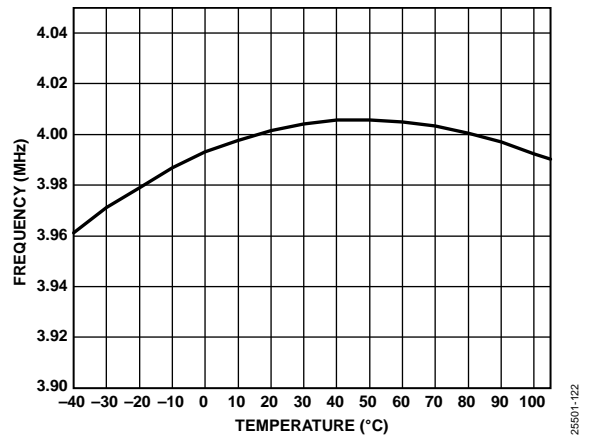

Figure 22. Internal Oscillator Frequency vs. Temperature

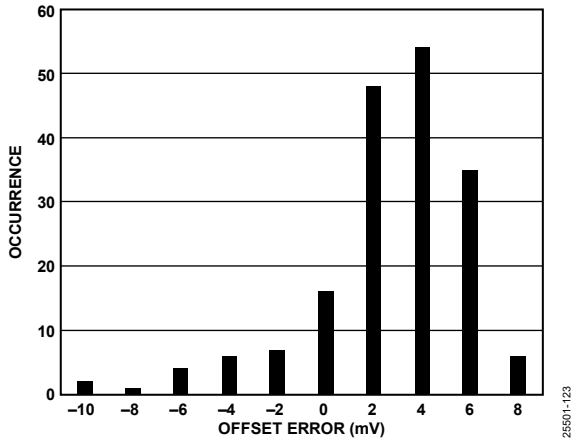

Figure 23. Offset Error Distribution Histogram (Voltage Input at 192.5  $\mu$ s Settling)

25501-123

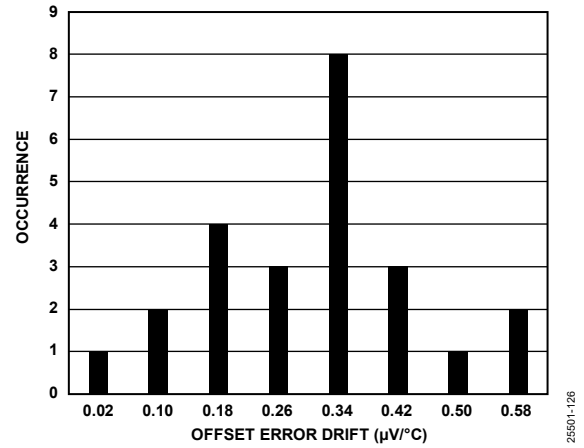

Figure 26. Offset Error Drift Distribution Histogram (Low Level Input)

25501-126

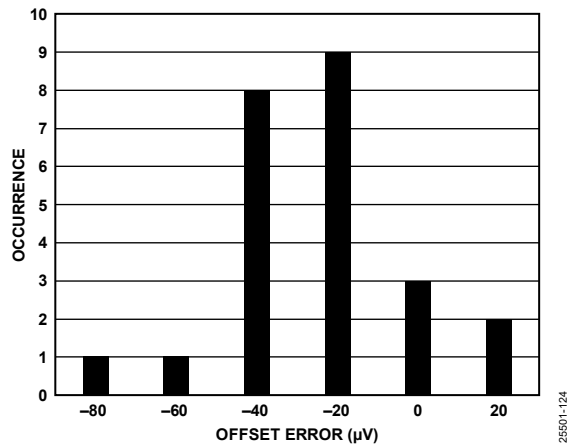

Figure 24. Offset Error Distribution Histogram (Low Level Input)

25501-124

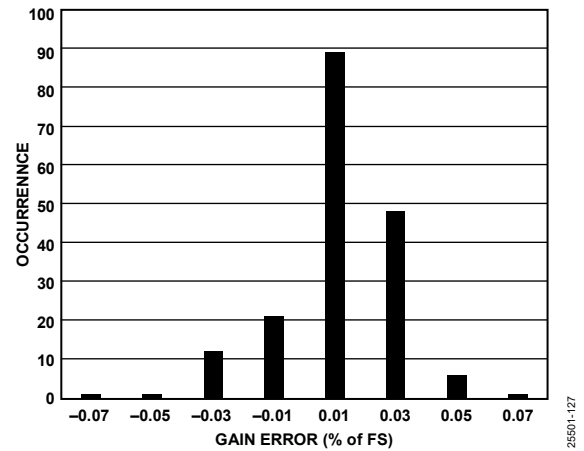

Figure 27. Gain Error Distribution Histogram (Voltage Input at 192.5  $\mu$ s Settling)

25501-127

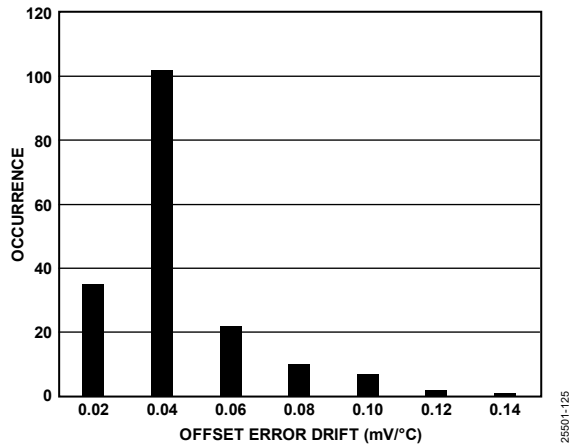

Figure 25. Offset Error Drift Distribution Histogram (Voltage Input at 192.5  $\mu$ s Settling)

25501-125

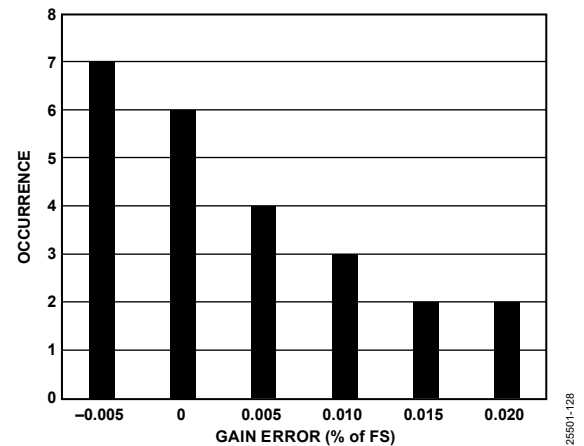

Figure 28. Gain Error Distribution Histogram (Low Level Input)

25501-128



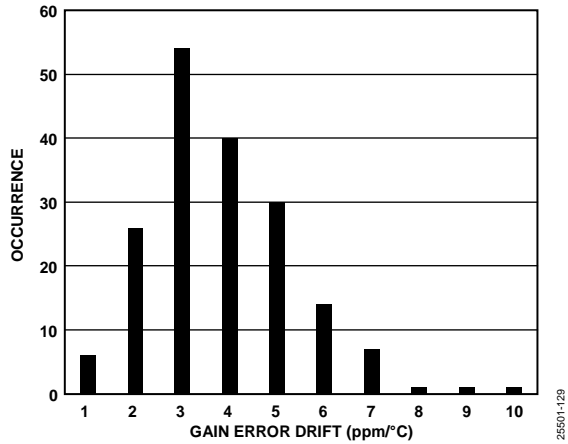

Figure 29. Gain Error Drift Distribution Histogram (Voltage Input at 192.5  $\mu$ s Settling)

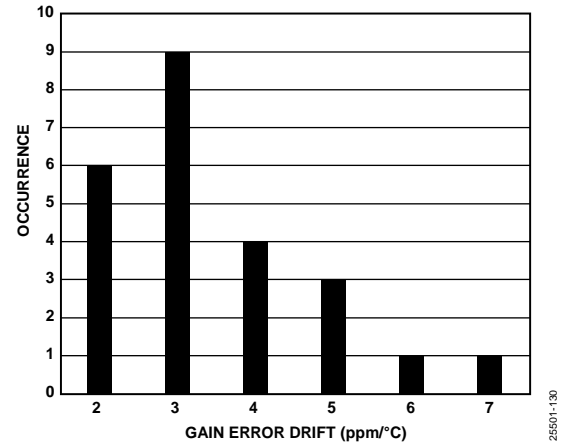

Figure 31. Gain Error Drift Distribution Histogram (Low Level Input)

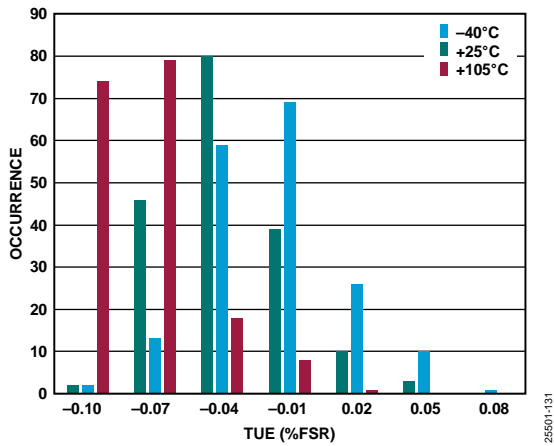

Figure 30. TUE Distribution Histogram (Voltage Input at 96.5  $\mu$ s Settling)

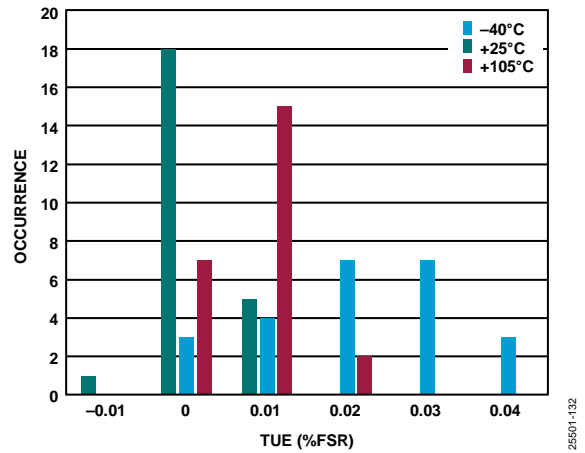

Figure 32. TUE Distribution Histogram (Low Level Input)

## NOISE PERFORMANCE AND RESOLUTION

Table 7 to Table 10 show the rms noise, peak-to-peak noise, effective resolution, and the noise free (peak-to-peak) resolution of the AD4116 for various ODRs. These values are typical and are measured with an external 2.5 V reference, analog input buffers enabled and with the ADC continuously converting on multiple channels. The values in Table 7 and Table 8 are generated for the  $\pm 10$  V voltage input range, with a

differential input voltage of 0 V. The values in Table 9 and Table 10 are generated for the  $\pm V_{REF}$  input range, with a differential input voltage of 0 V. It is important to note that the peak-to-peak resolution is calculated based on the peak-to-peak noise. The peak-to-peak resolution represents the resolution for which there is no code flicker.

**Table 7.  $\pm 10$  V Voltage Input RMS Noise Resolution vs. ODR Using a Sinc5 + Sinc1 Filter**

| Default ODR (SPS);<br>SING_CYC = 0 and<br>Single Channel Enabled | ODR (SPS per Channel);<br>SING_CYC = 1 or Multiple<br>Channels Enabled | Settling<br>Time <sup>1</sup> | Notch<br>Frequency<br>(Hz) | Noise<br>( $\mu\text{V rms}$ ) <sup>2</sup> | Effective<br>Resolution<br>(Bits) | Noise<br>( $\mu\text{V p-p}$ ) | Peak-to-Peak<br>Resolution<br>(Bits) |
|--|--|-------------------------------|----------------------------|---|-----------------------------------|--------------------------------|--------------------------------------|
| 62,500   | 12,422.36  | 80.5 $\mu\text{s}$            | 62,500                     | 326.60                                      | 15.90                             | 2038.60                        | 13.26                                |
| 31,250   | 10,362.69  | 96.5 $\mu\text{s}$            | 31,250                     | 271.80                                      | 16.17                             | 1778.01                        | 13.46                                |
| 15,625   | 7,782.1  | 128.5 $\mu\text{s}$           | 15,625                     | 209.60                                      | 16.54                             | 1360.18                        | 13.84                                |
| 10,416.7   | 6,230.53   | 160.5 $\mu\text{s}$           | 10,416.7                   | 171.80                                      | 16.83                             | 1093.80                        | 14.16                                |
| 5,194.8  | 5,194.8  | 192.5 $\mu\text{s}$           | 7,812.5                    | 151.40                                      | 17.01                             | 1006.20                        | 14.28                                |
| 2,496.9  | 2,496.9  | 400.5 $\mu\text{s}$           | 2,976.19                   | 95.46                                       | 17.68                             | 585.80                         | 15.06                                |
| 1007.6   | 1007.6   | 992.50 $\mu\text{s}$          | 1077.59                    | 56.48                                       | 18.43                             | 373.60                         | 15.71                                |
| 499.9  | 499.9  | 2.00 ms                       | 516.53                     | 39.56                                       | 18.95                             | 247.80                         | 16.30                                |
| 390.6  | 390.6  | 2.56 ms                       | 400.64                     | 35.82                                       | 19.09                             | 235.80                         | 16.37                                |
| 200.3  | 200.3  | 4.99 ms                       | 202.92                     | 25.72                                       | 19.57                             | 163.40                         | 16.90                                |
| 100.0  | 100.0  | 10.00 ms                      | 100.6                      | 19.08                                       | 20.00                             | 116.00                         | 17.40                                |
| 59.75  | 59.75  | 16.74 ms                      | 59.98                      | 15.22                                       | 20.33                             | 98.16                          | 17.64                                |
| 49.84  | 49.84  | 20.06 ms                      | 50                         | 14.07                                       | 20.44                             | 76.89                          | 17.99                                |
| 20.00  | 20.00  | 50.00 ms                      | 20.03                      | 10.32                                       | 20.89                             | 51.85                          | 18.56                                |
| 16.65  | 16.65  | 60.06 ms                      | 16.67                      | 9.62  | 20.99                             | 50.66                          | 18.59                                |
| 10.00  | 10.00  | 100.00 ms                     | 10.01                      | 8.67  | 21.14                             | 42.32                          | 18.85                                |
| 5.00   | 5.00   | 200.00 ms                     | 5                          | 7.78  | 21.29                             | 38.74                          | 18.98                                |
| 2.50   | 2.50   | 400.00 ms                     | 2.5                        | 6.52  | 21.55                             | 32.78                          | 19.22                                |
| 1.25   | 1.25   | 800.00 ms                     | 1.25                       | 6.23  | 21.61                             | 31.59                          | 19.27                                |

<sup>1</sup> The settling time is rounded to the nearest microsecond, which is reflected in the output data rate and channel switching rate. Channel switching rate =  $1 \div$  settling time.

<sup>2</sup> Based on 1000 samples for data rates  $\geq 59.75$  SPS per channel, and based on 100 samples for data rates  $\leq 49.84$  SPS per channel.

**Table 8.  $\pm 10$  V Voltage Input RMS Noise Resolution vs. ODR Using a Sinc3 Filter**

| Default ODR (SPS);<br>SING_CYC = 0 and<br>Single Channel Enabled | ODR (SPS per Channel);<br>SING_CYC = 1 or<br>Multiple Channels Enabled | Settling<br>Time <sup>1</sup> | Notch<br>Frequency<br>(Hz) | Noise<br>( $\mu\text{V rms}$ ) <sup>2</sup> | Effective<br>Resolution<br>(Bits) | Noise<br>( $\mu\text{V p-p}$ ) | Peak-to-Peak<br>Resolution<br>(Bits) |
|--|--|-------------------------------|----------------------------|---|-----------------------------------|--------------------------------|--------------------------------------|
| 62,500   | 20,618.56  | 48.5 $\mu\text{s}$            | 62,500                     | 1213.00                                     | 14.01                             | 7641.80                        | 11.35                                |
| 31,250   | 10,362.69  | 96.5 $\mu\text{s}$            | 31,250                     | 279.20                                      | 16.13                             | 1748.20                        | 13.49                                |
| 15,625   | 5,194.81   | 192.5 $\mu\text{s}$           | 15,625                     | 163.40                                      | 16.90                             | 1031.76                        | 14.24                                |
| 10,416.7   | 3,466.2  | 288.5 $\mu\text{s}$           | 10,416.7                   | 133.38                                      | 17.19                             | 891.69                         | 14.46                                |
| 5,208.3  | 1,734.61   | 576.5 $\mu\text{s}$           | 5,208.3                    | 95.20                                       | 17.68                             | 608.60                         | 15.01                                |
| 2,500  | 832.99   | 1.20 ms                       | 2,500                      | 64.90                                       | 18.23                             | 435.00                         | 15.49                                |
| 1008.1   | 335.97   | 2.98 ms                       | 1008.1                     | 41.82                                       | 18.87                             | 260.80                         | 16.23                                |
| 500  | 166.65   | 6.00 ms                       | 500                        | 30.12                                       | 19.34                             | 205.40                         | 16.57                                |
| 400.64   | 133.54   | 7.49 ms                       | 400.64                     | 27.68                                       | 19.46                             | 179.60                         | 16.77                                |
| 200.32   | 66.77  | 14.98 ms                      | 200.32                     | 20.22                                       | 19.92                             | 140.00                         | 17.12                                |
| 100.0  | 33.3   | 30.00 ms                      | 100.0                      | 15.30                                       | 20.32                             | 96.46                          | 17.67                                |
| 59.98  | 19.99  | 50.02 ms                      | 59.98                      | 12.88                                       | 20.57                             | 87.62                          | 17.81                                |
| 50   | 16.67  | 60.00 ms                      | 50.00                      | 12.40                                       | 20.62                             | 60.79                          | 18.34                                |
| 20   | 6.67   | 150.00 ms                     | 20.00                      | 8.64  | 21.14                             | 42.91                          | 18.83                                |
| 16.67  | 5.56   | 180.00 ms                     | 16.67                      | 8.34  | 21.20                             | 42.91                          | 18.79                                |

| Default ODR (SPS);<br>SING_CYC = 0 and<br>Single Channel Enabled | ODR (SPS per Channel);<br>SING_CYC = 1 or<br>Multiple Channels Enabled | Settling<br>Time <sup>1</sup> | Notch<br>Frequency<br>(Hz) | Noise<br>( $\mu\text{V rms}$ ) <sup>2</sup> | Effective<br>Resolution<br>(Bits) | Noise<br>( $\mu\text{V p-p}$ ) | Peak-to-Peak<br>Resolution<br>(Bits) |
|--|--|-------------------------------|----------------------------|---|-----------------------------------|--------------------------------|--------------------------------------|
| 10   | 3.33   | 300.00 ms                     | 10.00                      | 8.25  | 21.20                             | 42.91                          | 18.80                                |
| 5  | 1.67   | 600.00 ms                     | 5.00                       | 8.25  | 21.20                             | 41.72                          | 18.85                                |
| 2.5  | 0.83   | 1.20 sec                      | 2.50                       | 8.13  | 21.23                             | 41.72                          | 18.88                                |
| 1.25   | 0.42   | 2.4 sec                       | 1.25                       | 6.68  | 21.51                             | 33.38                          | 19.20                                |

<sup>1</sup> The settling time is rounded to the nearest microsecond, which is reflected in the output data rate and channel switching rate. Channel switching rate =  $1 \div$  settling time.

<sup>2</sup> Based on 1000 samples for data rates  $\geq 59.98$  SPS per channel, and based on 100 samples for data rates  $\leq 50$  SPS per channel.

Table 9.  $\pm\text{V}_{\text{REF}}$  Low-level Input RMS Noise Resolution vs. ODR Using a Sinc5 + Sinc1 Filter

| Default ODR (SPS);<br>SING_CYC = 0 and<br>Single Channel Enabled | ODR (SPS per Channel);<br>SING_CYC = 1 or Multiple<br>Channels Enabled | Settling<br>Time <sup>1</sup> | Notch<br>Frequency<br>(Hz) | Noise<br>( $\mu\text{V rms}$ ) <sup>2</sup> | Effective<br>Resolution<br>(Bits) | Noise<br>( $\mu\text{V p-p}$ ) | Peak-to-Peak<br>Resolution<br>(Bits) |
|--|--|-------------------------------|----------------------------|---|-----------------------------------|--------------------------------|--------------------------------------|
| 62,500   | 12,422.36  | 80.5 $\mu\text{s}$            | 62,500                     | 9.6   | 18.99                             | 63.36                          | 16.27                                |
| 31,250   | 10,362.69  | 96.5 $\mu\text{s}$            | 31,250                     | 8.3   | 19.20                             | 54.78                          | 16.48                                |
| 15,625   | 7,782.1  | 128.5 $\mu\text{s}$           | 15,625                     | 6.3   | 19.60                             | 41.58                          | 16.88                                |
| 10,416.7   | 6,230.53   | 160.5 $\mu\text{s}$           | 10,416.7                   | 6.1   | 19.79                             | 36.3                           | 17.07                                |
| 5,194.8  | 5,194.8  | 192.5 $\mu\text{s}$           | 7,812.5                    | 4.9   | 19.96                             | 32.34                          | 17.24                                |
| 2,496.9  | 2,496.9  | 400.5 $\mu\text{s}$           | 2,976.19                   | 3.2   | 20.58                             | 21.12                          | 17.85                                |
| 1007.6   | 1007.6   | 992.50 $\mu\text{s}$          | 1077.59                    | 1.95  | 21.29                             | 12.87                          | 18.57                                |
| 499.9  | 499.9  | 2.00 ms                       | 516.53                     | 1.3   | 21.87                             | 8.58                           | 19.15                                |
| 390.6  | 390.6  | 2.56 ms                       | 400.64                     | 1.2   | 21.99                             | 7.92                           | 19.27                                |
| 200.3  | 200.3  | 4.99 ms                       | 202.92                     | 0.85  | 22.49                             | 5.61                           | 19.77                                |
| 100.0  | 100.0  | 10.00 ms                      | 100.6                      | 0.6   | 22.99                             | 3.96                           | 20.27                                |
| 59.75  | 59.75  | 16.74 ms                      | 59.98                      | 0.45  | 23.41                             | 2.97                           | 20.68                                |
| 49.84  | 49.84  | 20.06 ms                      | 50                         | 0.4   | 23.58                             | 2.64                           | 20.85                                |
| 20.00  | 20.00  | 50.00 ms                      | 20.03                      | 0.26  | 24                                | 1.716                          | 21.47                                |
| 16.65  | 16.65  | 60.06 ms                      | 16.67                      | 0.23  | 24                                | 1.518                          | 21.65                                |
| 10.00  | 10.00  | 100.00 ms                     | 10.01                      | 0.18  | 24                                | 1.188                          | 22.00                                |
| 5.00   | 5.00   | 200.00 ms                     | 5                          | 0.13  | 24                                | 0.858                          | 22.47                                |
| 2.50   | 2.50   | 400.00 ms                     | 2.5                        | 0.09  | 24                                | 0.594                          | 23.00                                |
| 1.25   | 1.25   | 800.00 ms                     | 1.25                       | 0.07  | 24                                | 0.462                          | 23.37                                |

<sup>1</sup> The settling time is rounded to the nearest microsecond, which is reflected in the output data rate and channel switching rate. Channel switching rate =  $1 \div$  settling time.

<sup>2</sup> Based on 1000 samples for data rates  $\geq 59.98$  SPS per channel, and based on 100 samples for data rates  $\leq 50$  SPS per channel.

Table 10.  $\pm\text{V}_{\text{REF}}$  Low Level Input RMS Noise Resolution vs. ODR Using a Sinc3 Filter

| Default ODR (SPS);<br>SING_CYC = 0 and<br>Single Channel Enabled | ODR (SPS per Channel);<br>SING_CYC = 1 or Multiple<br>Channels Enabled | Settling<br>Time <sup>1</sup> | Notch<br>Frequency<br>(Hz) | Noise<br>( $\mu\text{V rms}$ ) <sup>2</sup> | Effective<br>Resolution<br>(Bits) | Noise<br>( $\mu\text{V p-p}$ ) | Peak-to-Peak<br>Resolution<br>(Bits) |
|--|--|-------------------------------|----------------------------|---|-----------------------------------|--------------------------------|--------------------------------------|
| 62,500   | 20,618.56  | 48.5 $\mu\text{s}$            | 62,500                     | 105   | 15.54                             | 693                            | 12.82                                |
| 31,250   | 10,362.69  | 96.5 $\mu\text{s}$            | 31,250                     | 14  | 18.45                             | 92.4                           | 15.72                                |
| 15,625   | 5,194.81   | 192.5 $\mu\text{s}$           | 15,625                     | 5.8   | 19.72                             | 38.28                          | 16.99                                |
| 10,416.7   | 3,466.2  | 288.5 $\mu\text{s}$           | 10,416.7                   | 4.7   | 20.02                             | 31.02                          | 17.30                                |
| 5,208.3  | 1,734.61   | 576.5 $\mu\text{s}$           | 5,208.3                    | 3.2   | 20.58                             | 21.12                          | 17.85                                |
| 2,500  | 832.99   | 1.20 ms                       | 2,500                      | 1.95  | 21.29                             | 12.87                          | 18.57                                |
| 1008.1   | 335.97   | 2.98 ms                       | 1008.1                     | 1.45  | 21.72                             | 9.57                           | 18.99                                |
| 500  | 166.65   | 6.00 ms                       | 500                        | 0.98  | 22.28                             | 6.468                          | 19.56                                |
| 400.64   | 133.54   | 7.49 ms                       | 400.64                     | 0.9   | 22.41                             | 5.94                           | 19.68                                |
| 200.32   | 66.77  | 14.98 ms                      | 200.32                     | 0.64  | 22.90                             | 4.224                          | 20.17                                |
| 100.0  | 33.3   | 30.00 ms                      | 100.0                      | 0.45  | 23.41                             | 2.97                           | 20.68                                |
| 59.98  | 19.99  | 50.02 ms                      | 59.98                      | 0.33  | 23.85                             | 2.178                          | 21.13                                |

| Default ODR (SPS);<br>SING_CYC = 0 and<br>Single Channel Enabled | ODR (SPS per Channel);<br>SING_CYC = 1 or Multiple<br>Channels Enabled | Settling<br>Time <sup>1</sup> | Notch<br>Frequency<br>(Hz) | Noise<br>( $\mu\text{V rms}$ ) <sup>2</sup> | Effective<br>Resolution<br>(Bits) | Noise<br>( $\mu\text{V p-p}$ ) | Peak-to-Peak<br>Resolution<br>(Bits) |
|--|--|-------------------------------|----------------------------|---|-----------------------------------|--------------------------------|--------------------------------------|
| 50   | 16.67  | 60.00 ms                      | 50.00                      | 0.3   | 23.99                             | 1.98                           | 21.27                                |
| 20   | 6.67   | 150.00 ms                     | 20.00                      | 0.2   | 24                                | 1.32                           | 21.85                                |
| 16.67  | 5.56   | 180.00 ms                     | 16.67                      | 0.17  | 24                                | 1.122                          | 22.09                                |
| 10   | 3.33   | 300.00 ms                     | 10.00                      | 0.14  | 24                                | 0.924                          | 22.37                                |
| 5  | 1.67   | 600.00 ms                     | 5.00                       | 0.098                                       | 24                                | 0.6468                         | 22.88                                |
| 2.5  | 0.83   | 1.20 sec                      | 2.50                       | 0.068                                       | 24                                | 0.4488                         | 23.41                                |
| 1.25   | 0.42   | 2.4 sec                       | 1.25                       | 0.06  | 24                                | 0.396                          | 23.59                                |

<sup>1</sup> The settling time is rounded to the nearest microsecond, which is reflected in the output data rate and channel switching rate. Channel switching rate =  $1 \div$  settling time.

<sup>2</sup> Based on 1000 samples for data rates  $\geq 59.98$  SPS per channel, and based on 100 samples for data rates  $\leq 50$  SPS per channel.

## THEORY OF OPERATION

The AD4116 offers the user a fast settling, high resolution, multiplexed ADC with high levels of configurability, including the following features:

- Six fully differential or eleven single-ended voltage inputs.
- A high impedance voltage divider with integrated precision matched resistors
- Embedded proprietary *i*Passives technology within a small device footprint.
- Two differential or four single-ended low level direct ADC inputs.
- Per channel configurability—up to eight different setups can be defined. A separate setup can be mapped to each of the channels. Each setup allows the user to configure whether the buffers are enabled or disabled, gain and offset correction, filter type, ODR, and reference source selection.
- Highly configurable digital filter enabling conversion rates up to 62.5 kSPS on a single channel and 12.422 kSPS switching using sinc5 + sinc1 filter.

The AD4116 includes a precision, 2.5 V, low drift (5 ppm/°C), band gap internal reference. This reference can be selected for use in ADC conversions, reducing the external component count. When enabled, the internal reference is output to the REFOUT pin. It can be used as a low noise biasing voltage for

the external circuitry and must be connected to a 0.1  $\mu$ F decoupling capacitor.

The AD4116 includes two separate linear regulator blocks for both the analog and digital circuitry. The analog LDO regulator regulates the AVDD supply to 1.8 V.

The linear regulator for the digital IOVDD supply performs a similar function, regulating the input voltage applied at the IOVDD pin to 1.8 V. The serial interface signals always operate from the IOVDD supply seen at the pin; meaning that, if 3.3 V is applied to the IOVDD pin, the interface logic inputs and outputs operate at this level.

The AD4116 is designed for a multitude of factory automation and process control applications, such as programmable logic controller (PLC) and distributed control system (DCS) modules. The AD4116 reduces overall system cost and design burden while maintaining a high level of accuracy. The AD4116 offers the following system benefits:

- A single 5 V power supply.
- A guaranteed minimum 10 M $\Omega$  input impedance.
- An overrange voltage greater than  $\pm 10$  V.
- A buffered low level input voltage.
- A high channel count
- Reduced calibration costs.

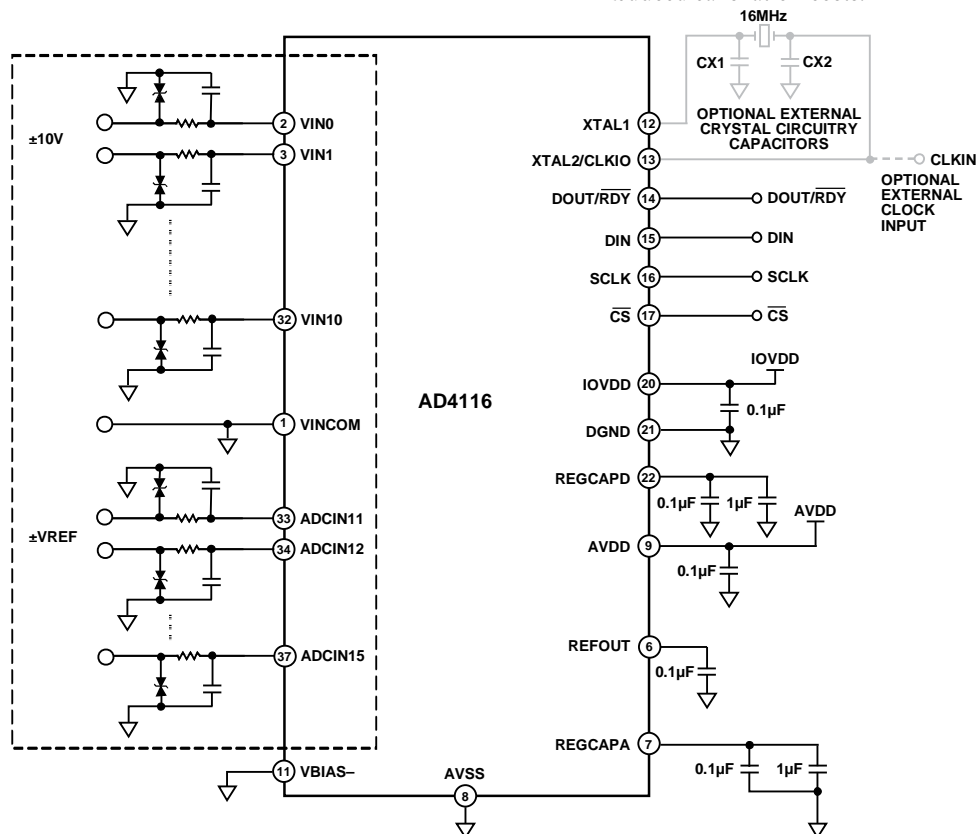

Figure 33. Typical Connection Diagram

2501-1031

## POWER SUPPLIES

The AD4116 has two independent power supply pins: AVDD and IOVDD. The AD4116 has no specific requirements for a power supply sequence. However, when all power supplies are stable, a device reset is required. See the AD4116 Reset section for details on how to reset the device.

AVDD powers the internal 1.8 V analog LDO regulator, which powers the ADC core. AVDD also powers the crosspoint multiplexer and integrated input buffers. AVDD is referenced to AVSS, and  $AVDD - AVSS = 5\text{ V}$ . AVDD and AVSS can be a single 5 V supply or  $\pm 2.5\text{ V}$  split supply. When using split supplies, consider the absolute maximum ratings (see the Absolute Maximum Ratings section).

IOVDD powers the internal 1.8 V digital LDO regulator. This regulator powers the digital logic of the ADC. IOVDD sets the voltage levels for the serial peripheral interface (SPI) of the ADC. IOVDD is referenced to DGND, and IOVDD to DGND can vary from 2 V (minimum) to 5.5 V (maximum).

### Single-Supply Operation (AVSS = DGND)

When the AD4116 is powered from a single supply connected to AVDD, the supply must be 5 V. In this configuration, AVSS and DGND can be shorted together on one single ground plane.

IOVDD can range from 2 V to 5.5 V in this unipolar input configuration.

## DIGITAL COMMUNICATION

The AD4116 has a 3-wire or 4-wire SPI that is compatible with QSPI™, MICROWIRE®, and DSPs. The interface operates in SPI Mode 3 and can be operated with  $\overline{\text{CS}}$  tied low. In SPI Mode 3, SCLK idles high, the falling edge of SCLK is the drive edge, and the rising edge of SCLK is the sample edge. Data is clocked out on the falling and drive edge and data is clocked in on the rising and sample edge.



Figure 34. SPI Mode 3 SCLK Edges

### Accessing the ADC Register Map

The communications register controls access to the full register map of the ADC. This register is an 8-bit write only register. On power-up or after a reset, the digital interface defaults to a state where it is expecting a write to the communications register. Therefore, all communication begins by writing to the communications register.

The data written to the communications register determines which register is being accessed and if the next operation is a read or write. The RA bits (Bits[5:0] in Register 0x00)

determine the specific register to which the read or write operation applies.

When the read or write operation to the selected register is complete, the interface returns to its default state, where it expects a write operation to the communications register.

In situations where interface synchronization is lost, a write operation of at least 64 serial clock cycles with DIN high returns the ADC to its default state by resetting the entire device, including the register contents. Alternatively, if  $\overline{\text{CS}}$  is being used with the digital interface, returning  $\overline{\text{CS}}$  high resets the digital interface to its default state and aborts any current operation.

Figure 35 and Figure 36 show writing to and reading from a register by first writing the 8-bit command to the communications register followed by the data for the addressed register.

Reading the ID register is the recommended method for verifying correct communication with the device. The ID register is a read only register and contains the value 0x34Dx for the AD4116

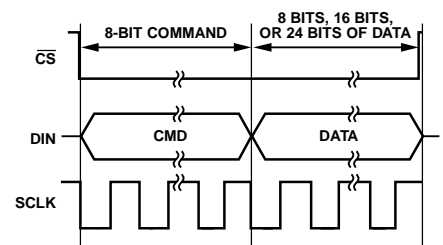

Figure 35. Writing to a Register (8-Bit Command with Register Address Followed by Data of 8 Bits, 16 Bits, or 24 Bits; Data Length Is Dependent on the Register Selected)

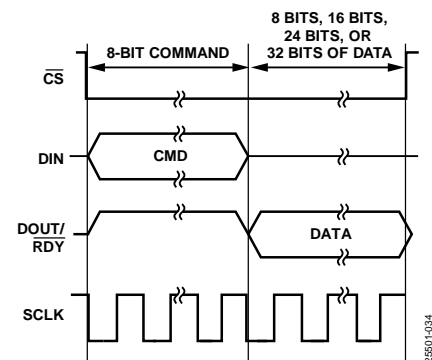

Figure 36. Reading from a Register (8-Bit Command with Register Address Followed by Data of 8 Bits, 16 Bits, 24, or 32 Bits; Data Length on DOUT Is Dependent on the Register Selected)

## AD4116 RESET

After a power-up cycle and when the power supplies are stable, a device reset is required. In situations where interface synchronization is lost, a device reset is also required. A write operation of at least 64 serial clock cycles with DIN high returns the ADC to the default state by resetting the entire device, including the register contents. Alternatively, if  $\overline{\text{CS}}$  is being used with the digital interface, returning  $\overline{\text{CS}}$  high sets the digital interface to the default state and halts any serial interface operation.

Table 11. Communications Register Bit Map

| Reg. | Name  | Bits  | Bit 7 | Bit 6 | Bit 5 | Bit 4 | Bit 3 | Bit 2 | Bit 1 | Bit 0 | Reset | RW |
|------|-------|-------|-------|-------|-------|-------|-------|-------|-------|-------|-------|----|
| 0x00 | COMMS | [7:0] | WEN   | R/W   | RA    |       |       |       |       |       | 0x00  | W  |

Table 12. ID Register Bit Map

| Reg. | Name | Bits   | Bit 7    | Bit 6 | Bit 5 | Bit 4 | Bit 3 | Bit 2 | Bit 1 | Bit 0 | Reset               | RW |
|------|------|--------|----------|-------|-------|-------|-------|-------|-------|-------|---------------------|----|
| 0x07 | ID   | [15:8] | ID[15:8] |       |       |       |       |       |       |       | 0x34DX <sup>1</sup> | R  |
|      |      | [7:0]  | ID[7:0]  |       |       |       |       |       |       |       |                     |    |

<sup>1</sup> X means don't care.

**CONFIGURATION OVERVIEW**

After power-on or reset, the AD4116 default configuration is as follows:

- Channel configuration: Channel 0 is enabled, and the VIN0 and VIN1 pair is selected as the input. Setup 0 is selected.
- Setup configuration: the analog input buffers are disabled, and the reference input buffers are also disabled. The REF± pins are selected as the reference source. Note that for this setup, the default channel does not operate correctly because the input buffers need to be enabled for a V<sub>IN</sub> input.
- Filter configuration: the sinc5 + sinc1 filter is selected and the maximum output data rate of 62.5 kSPS is selected.
- ADC mode: continuous conversion mode and the internal oscillator are enabled. The internal reference is disabled.
- Interface mode: CRC and the data and status output are disabled.

Note that only a few of the register setting options are shown. This list is only an example. For full register information, see the Register Details section.

Figure 37 shows an overview of the suggested flow for changing the ADC configuration, divided into the following three blocks:

- Channel configuration (see Box A in Figure 37)
- Setup configuration (see Box B in Figure 37)
- ADC mode and interface mode configuration (see Box C in Figure 37)

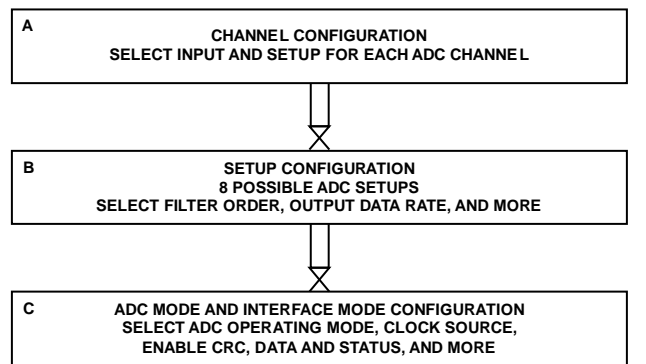

Figure 37. Suggested ADC Configuration Flow

Table 13. Channel Register 0

| Reg. | Name | Bits   | Bit 7      | Bit 6      | Bit 5 | Bit 4 | Bit 3    | Bit 2 | Bit 1      | Bit 0 | Reset  | RW |
|------|------|--------|------------|------------|-------|-------|----------|-------|------------|-------|--------|----|
| 0x10 | CH0  | [15:8] | CH_EN0     | SETUP_SELO |       |       | Reserved |       | INPUT[9:8] |       | 0x8001 | RW |
|      |      | [7:0]  | INPUT[7:0] |            |       |       |          |       |            |       |        |    |

**Channel Configuration**

The AD4116 has 16 independent channels and 8 independent setups. The user can select any of the input pairs on any channel, as well as any of the eight setups for any channel, giving the user full flexibility in the channel configuration. This flexibility also allows per channel configuration when using differential inputs and single-ended inputs because each channel can have its own dedicated setup.

**Channel Registers**

The channel registers select which of the voltage inputs is used for that channel. This register also contains a channel enable and disable bit and the setup selection bits, which are used to select which of the eight available setups to use for this channel.

When the AD4116 is operating with more than one channel enabled, the channel sequencer cycles through the enabled channels in sequential order, from Channel 0 to Channel 15. If a channel is disabled, it is skipped by the sequencer. Details of the channel register for Channel 0 are shown in Table 13.



**ADC Setups**

The AD4116 has eight independent setups. Each setup consists of the following four registers:

- Setup configuration registers
- Filter configuration registers
- Gain registers
- Offset registers

For example, Setup 0 consists of Setup Configuration Register 0, Filter Configuration Register 0, Gain Register 0, and Offset Register 0. Figure 38 shows the grouping of these registers. The setup is selectable from the channel registers (see the Channel Configuration section), which allows each channel to be assigned to one of eight separate setups. Table 14 through Table 17 show the four registers that are associated with Setup 0. This structure is repeated for Setup 1 to Setup 7.

**Setup Configuration Registers**

The setup configuration registers allow the user to select the output coding of the ADC by selecting between bipolar mode and unipolar mode. The user can select the reference source using these registers. Three options are available: a reference connected between the REF+ and REF– pins, the internal reference, or using AVDD – AVSS. The input and reference buffers can also be enabled or disabled using these registers.

**Filter Configuration Registers**

The filter configuration registers select which digital filter is used at the output of the ADC modulator. The order of the filter and the output data rate are selected by setting the bits in these registers. For more information, see the Digital Filter section.

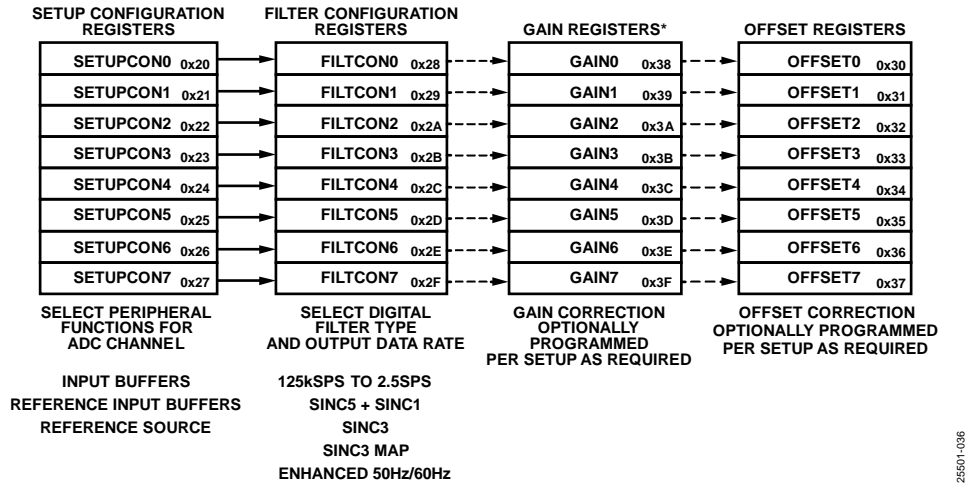

Figure 38. ADC Setup Register Grouping

**Table 14. Setup Configuration Register 0**

| Reg. | Name      | Bits   | Bit 7    | Bit 6    | Bit 5    | Bit 4        | Bit 3    | Bit 2    | Bit 1  | Bit 0 | Reset  | RW |
|------|-----------|--------|----------|----------|----------|--------------|----------|----------|--------|-------|--------|----|
| 0x20 | SETUPCON0 | [15:8] | Reserved |          |          | BI_UNIPOLAR0 | REFBUF0+ | REFBUF0– | INBUF0 |       | 0x1000 | RW |
|      |           | [7:0]  | Reserved | Reserved | REF_SELO |              | Reserved |          |        |       |        |    |

**Table 15. Filter Configuration Register 0**

| Reg. | Name     | Bits   | Bit 7      | Bit 6    | Bit 5 | Bit 4 | Bit 3      | Bit 2    | Bit 1 | Bit 0 | Reset  | RW |
|------|----------|--------|------------|----------|-------|-------|------------|----------|-------|-------|--------|----|
| 0x28 | FILTCON0 | [15:8] | SINC3_MAP0 | Reserved |       |       | ENHFILTENO | ENHFILTO |       |       | 0x0500 | RW |
|      |          | [7:0]  | Reserved   | ORDER0   |       | ODR0  |            |          |       |       |        |    |

**Table 16. Gain Register 0**

| Reg. | Name  | Bits   | Bits[23:0]  |  |  |  |  |  |  |  | Reset    | RW |
|------|-------|--------|-------------|--|--|--|--|--|--|--|----------|----|
| 0x38 | GAIN0 | [23:0] | GAIN0[32:0] |  |  |  |  |  |  |  | 0x5XXXX0 | RW |

**Table 17. Offset Register 0**

| Reg. | Name    | Bits   | Bits[15:0]    |  |  |  |  |  |  |  | Reset    | RW |
|------|---------|--------|---------------|--|--|--|--|--|--|--|----------|----|
| 0x30 | OFFSET0 | [23:0] | OFFSET0[23:0] |  |  |  |  |  |  |  | 0x800000 | RW |

### Gain Registers

The gain registers are 24-bit registers that hold the gain calibration coefficient for the ADC. The gain registers are read and write registers. The power-on reset value of the gain registers is 0x5XXXX0. The gain registers are 24-bit read and write registers.

### Offset Registers

The offset registers hold the offset calibration coefficient for the ADC. The power-on reset value of the offset registers is 0x800000. The offset registers are 24-bit read and write registers.

### ADC Mode and Interface Mode Configuration

The ADC mode register and the interface mode register configure the core peripherals for use by the AD4116 and the mode for the digital interface.

### ADC Mode Register

The ADC mode register primarily sets the conversion mode of the ADC to either continuous or single conversion. The user can also select the standby and power-down modes, as well as any of the calibration modes. In addition, this register contains the clock source select bits and internal reference enable bit. The reference select bits are contained in the setup configuration registers (see the ADC Setups section for more information). The details of this register are shown in Table 18.

### Interface Mode Register

The interface mode register configures the digital interface operation. This register allows the user to control data-word length, CRC enable, data plus status read, and continuous read mode. The details of this register are shown in Table 19. For more information, see the Digital Interface section.

**Table 18. ADC Mode Register**

| Reg. | Name    | Bits   | Bit 7    | Bit 6    | Bit 5    | Bit 4    | Bit 3    | Bit 2 | Bit 1    | Bit 0 | Reset  | RW |
|------|---------|--------|----------|----------|----------|----------|----------|-------|----------|-------|--------|----|
| 0x01 | ADCMODE | [15:8] | REF_EN   | Reserved | SING_CYC | Reserved |          | Delay |          |       | 0x2000 | RW |
|      |         | [7:0]  | Reserved | Mode     |          |          | CLOCKSEL |       | Reserved |       |        |    |

**Table 19. Interface Mode Register**

| Reg. | Name   | Bits   | Bit 7    | Bit 6     | Bit 5     | Bit 4    | Bit 3      | Bit 2    | Bit 1    | Bit 0      | Reset  | RW |
|------|--------|--------|----------|-----------|-----------|----------|------------|----------|----------|------------|--------|----|
| 0x02 | IFMODE | [15:8] | Reserved |           |           | ALT_SYNC | IOSTRENGTH | Reserved |          | DOUT_RESET | 0x0000 | RW |
|      |        | [7:0]  | CONTREAD | DATA_STAT | REG_CHECK | Reserved | CRC_EN     |          | Reserved | WL16       |        |    |

# CIRCUIT DESCRIPTION

## MULTIPLEXER

There are 12 standard voltage VIN pins and five low level voltage ADCIN pins: VIN0 to VIN10, VINCOM, ADCIN11 to ADCIN15. Each of these pins connects to the internal multiplexer. The multiplexer enables these inputs to be configured as input pairs (see the Voltage Inputs section and the Low Level Inputs section for more information on how to setup these inputs). The AD4116 can have up to 16 active channels. When more than one channel is enabled, the channels are automatically sequenced in order from the lowest enabled channel number to the highest enabled channel number. The output of the multiplexer is connected to the input of the integrated true rail-to-rail buffers. These buffers can be bypassed, and the multiplexer output can be directly connected to the switched capacitor input of the ADC. The simplified input circuits are shown in Figure 39 and Figure 40.

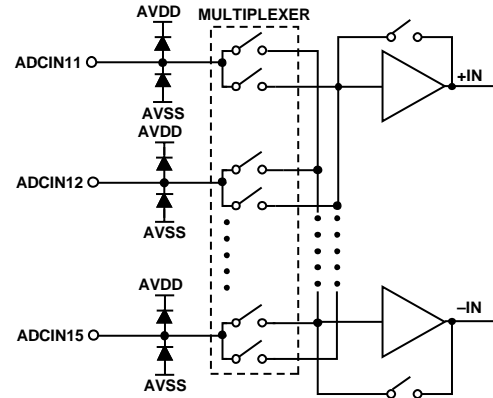

Figure 39. Simplified Low Level Input Circuit

25501-037

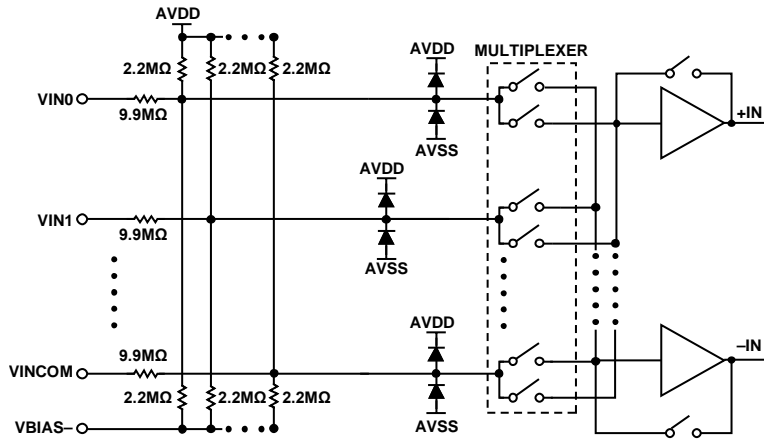

Figure 40. Simplified Voltage Input Circuit

25501-038

## VOLTAGE INPUTS

The unique integrated AFE of the AD4116 allows the user to configure for eleven single-ended inputs or six fully differential inputs. The integrated precision voltage divider on the analog front end has a division ratio of 10 and contains Analog Devices unique and patented *i*Passives technology to provide high impedance precision matched resistors that enable an input range of  $\pm 20$  V from a single +5 V power supply. Due to the high input impedance on the analog front end, the conversion accuracy of the voltage inputs may be dependent on the selected output data rate when switching between channels or when SING\_CYC is enabled. For high output data rates, the settling time is short; therefore, the large input impedance can influence the accuracy. If a slower output data rate is selected, the error is reduced as the ADC takes more time to process the analog input, which allows sufficient time for the front end to settle. Therefore, performing conversions at longer settling time minimizes the error.

Enable the input buffers in the corresponding setup configuration register for the voltage input channels (see Table 34).

### Fully Differential Inputs

The differential inputs are paired together in the following pairs: VIN0 and VIN1, VIN2 and VIN3, VIN4 and VIN5, VIN6 and VIN7, VIN8 and VIN9, VIN10 and VINCOM.

### Single-Ended Inputs

The user can measure up to 11 different single-ended voltage inputs. In this case, each voltage input must be paired with the VINCOM pin. Connect the VINCOM pin externally to the AVSS pin.

## LOW LEVEL INPUTS

There are five low level input pins: ADCIN11, ADCIN12, ADCIN13, ADCIN14, and ADCIN15. Each of these pins connects to the internal crosspoint multiplexer. The crosspoint multiplexer enables any of these inputs to be configured as an input pair, either single-ended or fully differential.

The output of the multiplexer is connected to the input of the integrated true rail-to-rail buffers. These buffers can be bypassed, and the multiplexer output can be directly connected to the switched capacitor input of the ADC. In buffered mode, the input channel feeds into a high impedance input stage of the buffer amplifier. Therefore, the input can tolerate significant source impedances and is tailored for direct connection to external resistive input protection or EMC filtering. When operating the device in unbuffered mode, the device has a higher analog input current. Note that this unbuffered input path provides a dynamic load to the driving source. Therefore, RC combinations on the input pins can cause gain errors, depending on the output impedance of the source that is driving the ADC input.

### Fully Differential Inputs

The differential low level inputs are paired together in the following pairs: ADCIN11 and ADCIN12, ADCIN13 and ADCIN14.

### Single-Ended or Pseudo Differential Inputs

The user can measure up to four different single-ended or pseudo differential, low level voltage inputs. In this case, each voltage input must be paired with the ADCIN15 pin as the input common pin. An example is to connect the ADCIN15 pin externally to the AVSS pin in a single-ended configuration, meaning that the ADC can only convert positive input voltages. Another example is to connect ADCIN15 to the REFOUT voltage (that is, AVSS + 2.5 V) in a pseudo differential configuration, and then differential voltages from  $-2.5$  V to  $+2.5$  V can be converted.

## ABSOLUTE INPUT PIN VOLTAGES

### Voltage Inputs

The AD4116 voltage input pins are specified for an accuracy of  $\pm 10$  V, specifically for the differential voltage between any two voltage input pins.

The voltage input pins have separate specifications for the absolute voltage that can be applied, and the unique design of the voltage divider network of the analog front end enables overvoltage robustness on the AD4116, meaning that the allowed overvoltages vary depending on the AVDD supply. Figure 41 shows the different degrees of robustness that can be achieved for AVDD = 5 V. Figure 41 provides a visual representation and guidance on how an overvoltage on a voltage pin can affect the overall device accuracy.

The guaranteed accuracy section of Figure 41 shows the voltage range that can be applied to a voltage input pin and achieve guaranteed accuracy.

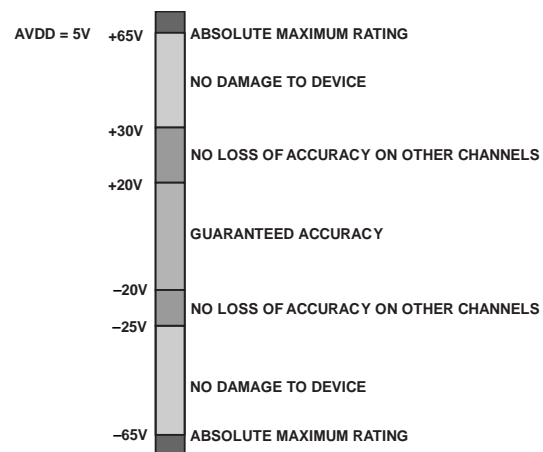

Figure 41. Absolute Input Pin Voltages, AVDD = 5 V

The no loss of accuracy sections show the voltage levels that can be applied without degrading the accuracy of other channels.

The no damage to device sections show the allowable positive and negative voltages that can be applied to a voltage input pin without exceeding the absolute maximum. The performance of other channels is degraded, but the performance recovers when the overvoltage is removed. This voltage range is specified as an absolute maximum rating of  $\pm 65$  V. Operation beyond the maximum operating conditions for extended periods can affect product reliability.

### Low Level Inputs

The absolute, low level, input voltage in unbuffered mode includes the range between  $AVSS - 50$  mV and  $AVDD + 50$  mV. The absolute input voltage range in buffered mode is restricted to a range between  $AVSS$  and  $AVDD$ . This low level input voltage is specified with an absolute maximum rating of  $AVSS - 0.3$  V to  $AVDD + 0.3$  V.

## DATA OUTPUT CODING

### Voltage Inputs

When the ADC is configured for unipolar operation, the output code is natural (straight) binary with a zero differential input voltage resulting in a code of 00 ... 00, a midscale voltage resulting in a code of 100 ... 000, and a full-scale input voltage resulting in a code of 111 ... 111.

The output code for any input voltage is represented as

$$Code = (2^N \times V_{IN} \times 0.1) / V_{REF}$$

When the ADC is configured for bipolar operation, the output code is offset binary with a negative full-scale voltage resulting in a code of 000 ... 000, a zero differential input voltage resulting in a code of 100 ... 000, and a positive full-scale input voltage resulting in a code of 111 ... 111. The output code for any analog input voltage can be represented as

$$Code = 2^{N-1} \times ((V_{IN} \times 0.1 / V_{REF}) + 1)$$

where:

$N = 24$ .

$V_{IN}$  is the input voltage.

$V_{REF}$  is the reference voltage.

### Low Level Inputs

When the ADC is configured for unipolar operation, the output code is natural (straight) binary with a zero differential input voltage resulting in a code of 00 ... 00, a midscale voltage resulting in a code of 100 ... 000, and a full-scale input voltage resulting in a code of 111 ... 111. The output code for any low-level input voltage is represented as

$$Code = (2^N \times V_{ADCIN}) / V_{REF}$$

When the ADC is configured for bipolar operation, the output code is offset binary with a negative full-scale voltage resulting

in a code of 000 ... 000, a zero differential input voltage resulting in a code of 100 ... 000, and a positive full-scale input voltage resulting in a code of 111 ... 111. The output code for any low-level input voltage is represented as

$$Code = 2^{N-1} \times ((V_{ADCIN} / V_{REF}) + 1)$$

where:

$N = 24$ .

$V_{REF}$  is the reference voltage.

$V_{ADCIN}$  is the low level input voltage.

## AD4116 REFERENCE

The AD4116 offers the user the option of either supplying an external reference to the REF+ and REF– pins of the device, using  $AVDD - AVSS$ , or by allowing the use of the internal 2.5 V, low noise, low drift reference. Select the reference source to be used by the analog input by setting the REF\_SELx bits, Bits[5:4], in the setup configuration registers appropriately. By default, the AD4116 uses an external reference on power-up.

### Internal Reference

The AD4116 includes a low noise, low drift voltage reference. The internal reference has a 2.5 V output. The internal reference is output on the REFOUT pin after the REF\_EN bit in the ADC mode register is set and is decoupled to  $AVSS$  with a 0.1  $\mu$ F capacitor. The AD4116 internal reference is disabled by default on power-up.

### External Reference

The AD4116 has a fully differential reference input applied through the REF+ and REF– pins. Standard low noise, low drift voltage references, such as the [ADR4525](#), are recommended for use. Apply the external reference to the AD4116 reference pins as shown in Figure 42. Decouple the output of any external reference to  $AVSS$ . As shown in Figure 42, the [ADR4525](#) output is decoupled with a 0.1  $\mu$ F capacitor at the output for stability purposes. The output is then connected to a 4.7  $\mu$ F capacitor, which acts as a reservoir for any dynamic charge required by the ADC and is followed by a 0.1  $\mu$ F decoupling capacitor at the REF+ input. This capacitor is placed as close as possible to the REF+ and REF– pins.

The REF– pin is connected directly to the  $AVSS$  potential. When an external reference is used instead of the internal reference to supply the AD4116, attention must be paid to the output of the REFOUT pin. The internal reference is controlled by the REF\_EN bit (Bit 15) in the ADC mode register. If the internal reference is not being used elsewhere in the application, ensure that the REF\_EN bit is disabled.

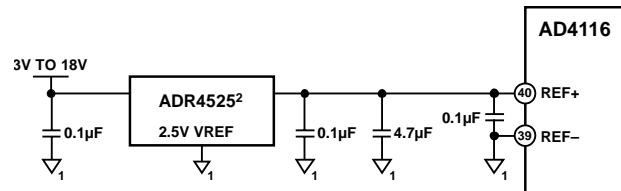

<sup>1</sup> ALL DECOUPLING IS TO AVSS.  
<sup>2</sup> ANY OF THE ADR452x FAMILY REFERENCES CAN BE USED.  
 ADR4525 ENABLES REUSE OF THE 5V ANALOG SUPPLY  
 NEEDED FOR AVDD TO POWER THE REFERENCE  $V_{IN}$ .

25501-040

Figure 42. ADR4525 Connected to AD4116 REF± Pins

Table 20. Setup Configuration 0 Register

| Reg. | Name      | Bits   | Bit 7    | Bit 6    | Bit 5    | Bit 4        | Bit 3    | Bit 2    | Bit 1  | Bit 0 | Reset  | RW |
|------|-----------|--------|----------|----------|----------|--------------|----------|----------|--------|-------|--------|----|
| 0x20 | SETUPCON0 | [15:8] | Reserved |          |          | BI_UNIPOLAR0 | REFBUF0+ | REFBUF0- | INBUF0 |       | 0x1000 | RW |
|      |           | [7:0]  | Reserved | Reserved | REF_SELO |              | Reserved |          |        |       |        |    |

Table 21. ADC Mode Register

| Reg. | Name    | Bits   | Bit 7    | Bit 6    | Bit 5    | Bit 4    | Bit 3    | Bit 2 | Bit 1    | Bit 0 | Reset  | RW |
|------|---------|--------|----------|----------|----------|----------|----------|-------|----------|-------|--------|----|
| 0x01 | ADCMODE | [15:8] | REF_EN   | Reserved | SING_CYC | Reserved |          | Delay |          |       | 0x2000 | RW |
|      |         | [7:0]  | Reserved | Mode     |          |          | CLOCKSEL |       | Reserved |       |        |    |

## BUFFERED REFERENCE INPUT

The AD4116 has true rail-to-rail, integrated, precision unity gain buffers on both ADC reference inputs. The buffers provide the benefit of providing high input impedance and allowing high impedance external sources to be directly connected to the reference inputs. The integrated reference buffers can fully drive the internal reference switch capacitor sampling network, simplifying the reference circuit requirements. Each reference input buffer amplifier is fully chopped, meaning that it minimizes the offset error drift and  $1/f$  noise of the buffer. When using a reference, such as the ADR4525, these buffers are not required because these references, with proper decoupling, can drive the reference inputs directly.

## CLOCK SOURCE

The AD4116 uses a nominal master clock of 4 MHz. The AD4116 can source its sampling clock from one of three sources:

- An internal oscillator
- An external crystal (use a 16 MHz crystal automatically divided internally to set the 4 MHz clock)
- An external clock source

All output data rates listed in this data sheet relate to a master clock rate of 4 MHz. Using a lower clock frequency from, for instance, an external source scales any listed data rate proportionally. To achieve the specified data rates, particularly rates for rejection of 50 Hz and 60 Hz, use a 4 MHz clock. The source of the master clock is selected by setting the CLOCKSEL bits (Bits[3:2]) in the ADC mode register. The default operation on power-up and reset of the AD4116 is to operate with the internal oscillator. It is possible to fine tune the output data rate and filter notch at low output data rates using the SINC3\_MAPx bits.

## Internal Oscillator

The internal oscillator runs at 16 MHz and is internally divided down to 4 MHz for the modulator and can be used as the ADC master clock. The internal oscillator is the default clock source for the AD4116 and is specified with an accuracy of  $-2.5\%$  to  $+2.5\%$ .

There is an option to allow the internal clock oscillator to be output on the XTAL2/CLKIO pin. The clock output is driven to the IOVDD logic level. This option can affect the dc performance of the AD4116 due to the disturbance introduced by the output driver. The extent to which the performance is affected depends on the IOVDD voltage supply. Higher IOVDD voltages create a wider logic output swing from the driver and affect performance to a greater extent. This effect is further exaggerated if the IOSTRENGTH bit is set at higher IOVDD levels.

### External Crystal

If higher precision, lower jitter clock sources are required, the AD4116 can use an external crystal to generate the master clock. The crystal is connected to the XTAL1 and XTAL2/CLKIO pins. A recommended crystal for use is the FA-20H, a 16 MHz, 10 ppm, 9 pF crystal from Epson-Toyocom that is available in a surface-mount package. As shown in Figure 43, insert two capacitors (CX1 and CX2) from the traces connecting the crystal to the XTAL1 and XTAL2/CLKIO pins. These capacitors allow circuit tuning. Connect these capacitors to the DGND pin. The value for these capacitors depends on the length and capacitance of the trace connections between the crystal and the XTAL1 and XTAL2/CLKIO pins. Therefore, the values of these capacitors differ depending on the PCB layout and the crystal used.

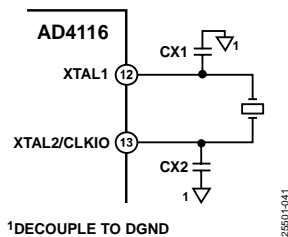

Figure 43. External Crystal Connections

The external crystal circuitry can be sensitive to the SCLK edges, depending on the SCLK frequency, IOVDD voltage, crystal circuitry layout, and the crystal used. During crystal startup, any disturbances caused by the SCLK edges may cause double edges on the crystal input, resulting in invalid conversions until the crystal voltage has reached a high enough level such that any interference from the SCLK edges is insufficient to cause double clocking. This double clocking can be avoided by ensuring that the crystal circuitry has reached a sufficient voltage level after startup before applying any SCLK.

Because of the nature of the crystal circuitry, it is recommended that empirical testing of the circuit be performed under the required conditions, with the final PCB layout and crystal, to ensure correct operation.

### External Clock

The AD4116 can also use an externally supplied clock. In systems where an externally supplied clock is used, the external clock is routed to the XTAL2/CLKIO pin. In this configuration, the XTAL2/CLKIO pin accepts the externally sourced clock and routes it to the modulator. The logic level of this clock input is defined by the voltage applied to the IOVDD pin.

## DIGITAL FILTER

The AD4116 has three flexible filter options to allow optimization of noise, settling time, and rejection:

- The sinc5 + sinc1 filter.
- The sinc3 filter.
- Enhanced 50 Hz and 60 Hz rejection filters.

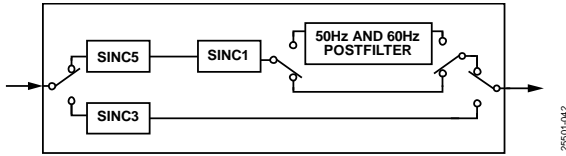

Figure 44. Digital Filter Block Diagram

The filter and output data rate are configured by setting the appropriate bits in the filter configuration register for the selected setup. Each channel can use a different setup and therefore, a different filter and output data rate. See the Register Details for more information.

### SINC5 + SINC1 FILTER

The sinc5 + sinc1 filter is targeted at multiplexed applications and achieves single cycle settling at output data rates of 5.195 kSPS and less. The sinc5 block output is fixed at the maximum rate of 62.5 kSPS, and the sinc1 block output data rate can be varied to control the final ADC output data rate. Figure 45 shows the frequency domain response of the sinc5 + sinc1 filter at a 50 SPS output data rate. The sinc5 + sinc1 filter has a slow roll-off over frequency and narrow notches.

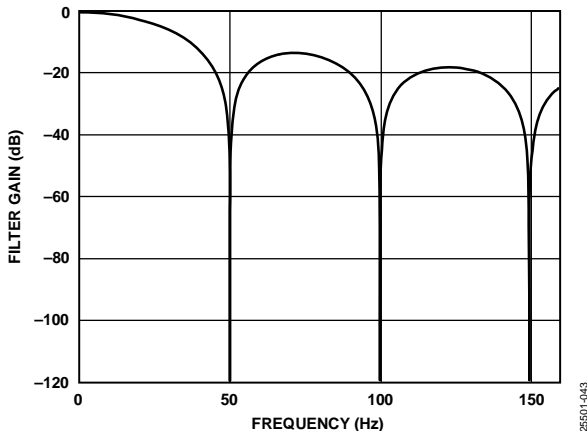

Figure 45. Sinc5 + Sinc1 Filter Response at 50 SPS ODR

The output data rates with the accompanying settling time and rms noise for the sinc5 + sinc1 filter are shown in in Table 7 and Table 9.

### SINC3 FILTER

The sinc3 filter achieves the best single-channel noise performance at lower rates and is, therefore, most suitable for single-channel applications. The sinc3 filter always has a settling time equal to

$$t_{SETTLE} = 3/\text{Output Data Rate}$$

Figure 46 shows the frequency domain filter response for the sinc3 filter. The sinc3 filter has good roll-off over frequency and has wide notches for good notch frequency rejection.

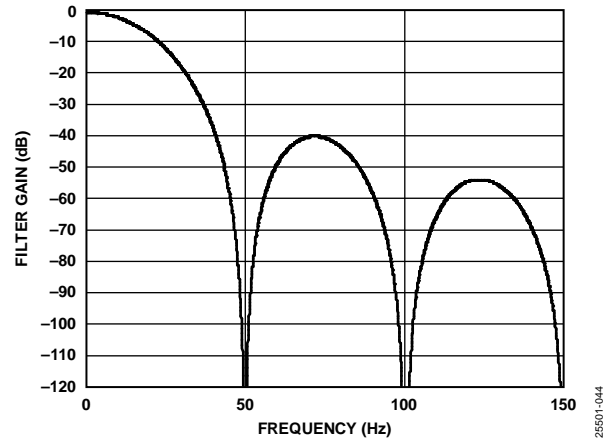

Figure 46. Sinc3 Filter Response

The output data rates with the accompanying settling time and rms noise for the sinc3 filter are shown in Table 8 and Table 10. It is possible to fine tune the output data rate for the sinc3 filter by setting the SINC3\_MAPx bit in the filter configuration registers. If this bit is set, the mapping of the filter register changes to directly program the decimation rate of the sinc3 filter. All other options are eliminated. The data rate when on a single channel can be calculated using the following equation:

$$\text{Output Data Rate} = f_{MOD}/(32 \times \text{FILTCONx}[14:0])$$

where:

$f_{MOD}$  is the modulator rate (MCLK/2) and is equal to 2 MHz.

$\text{FILTCONx}[14:0]$  are the contents on the filter configuration registers, excluding the MSB.

For example, an output data rate of 50 SPS can be achieved with SINC3\_MAPx enabled by setting the  $\text{FILTCONx}[14:0]$  bits to a value of 1,250.



**SINGLE CYCLE SETTling**

The AD4116 can be configured by setting the SING\_CYC bit in the ADC mode register so that only fully settled data is output, thus effectively putting the ADC into a single cycle settling mode. This mode achieves single cycle settling by reducing the output data rate to be equal to the settling time of the ADC for the selected output data rate. This bit has no effect with the sinc5 + sinc1 filter at output data rates of 5.195 kSPS and less or when multiple channels are enabled.

Figure 47 shows a step on the analog input with single cycle settling mode disabled and the sinc3 filter selected. The analog input requires at least three cycles after the step change for the output to reach the final settled value.

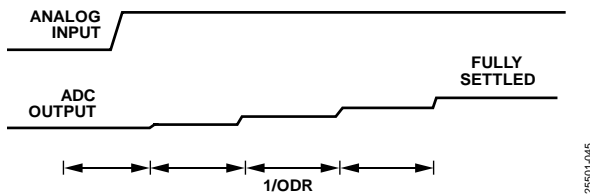

Figure 47. Step Input Without Single Cycle Settling

25501-045

Figure 48 shows the same step on the analog input but with single cycle settling enabled. The analog input requires at least a single cycle for the output to be fully settled. The output data rate, as indicated by the RDY signal, is now reduced to equal the settling time of the filter at the selected output data rate.

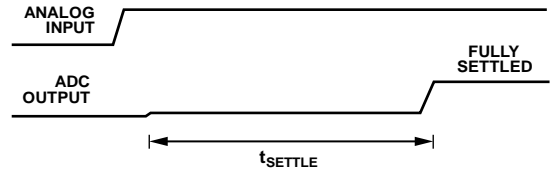

Figure 48. Step Input with Single Cycle Settling

25501-046

**ENHANCED 50 Hz AND 60 Hz REJECTION FILTERS**

The enhanced filters provide rejection of 50 Hz and 60 Hz simultaneously and allow the user to trade off settling time and rejection. These filters can operate at up to 27.27 SPS or can reject up to 90 dB of 50 Hz ± 1 Hz and 60 Hz ± 1 Hz interference. These filters are operated by post filtering the output of the sinc5 + sinc1 filter. For this reason, the sinc5 + sinc1 filter must be selected when using the enhanced filters to achieve the specified settling time and noise performance.

Table 22. Enhanced Filter Output Data Rate, Settling Time, Rejection, and Voltage Input Noise

| Output Data Rate (SPS) | Settling Time (ms) | Simultaneous Rejection of 50 Hz ± 1 Hz and 60 Hz ± 1 Hz (dB) <sup>1</sup> | Noise (µV rms) | Peak-to-Peak Resolution (Bits) | Comments                    |
|------------------------|--------------------|---|----------------|--------------------------------|-----------------------------|
| 27.27                  | 36.67              | 47  | 13.24          | 17.72                          | See Figure 49 and Figure 52 |
| 25                     | 40                 | 62  | 12.81          | 17.87                          | See Figure 50 and Figure 53 |
| 20                     | 50                 | 85  | 12.48          | 17.86                          | See Figure 51 and Figure 54 |
| 16.667                 | 60                 | 90  | 11.99          | 17.91                          | See Figure 55 and Figure 56 |

<sup>1</sup> Master clock = 4.00 MHz.

Table 23. Enhanced Filter Output Data Rate, Settling Time, Rejection, and Low Level Input Noise

| Output Data Rate (SPS) | Settling Time (ms) | Simultaneous Rejection of 50 Hz ± 1 Hz and 60 Hz ± 1 Hz (dB) <sup>1</sup> | Noise (µV rms) | Peak-to-Peak Resolution (Bits) | Comments                    |
|------------------------|--------------------|---|----------------|--------------------------------|-----------------------------|
| 27.27                  | 36.67              | 47  | 0.34           | 21.19                          | See Figure 49 and Figure 52 |
| 25                     | 40                 | 62  | 0.34           | 21.19                          | See Figure 50 and Figure 53 |
| 20                     | 50                 | 85  | 0.3            | 21.42                          | See Figure 51 and Figure 54 |
| 16.667                 | 60                 | 90  | 0.3            | 21.42                          | See Figure 55 and Figure 56 |

<sup>1</sup> Master clock = 4.00 MHz.

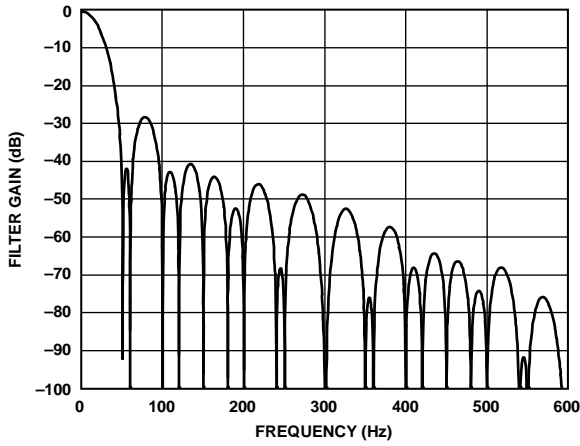

Figure 49. 27.27 SPS ODR, 36.67 ms Settling Time

25501-047

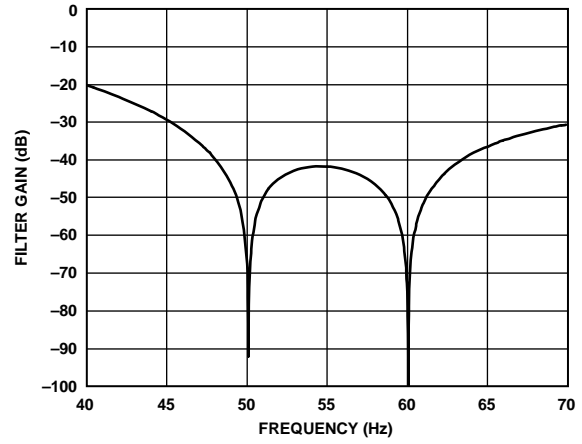

Figure 52. 27.27 SPS ODR, 36.67 ms Settling Time (40 Hz to 70 Hz)

25501-050

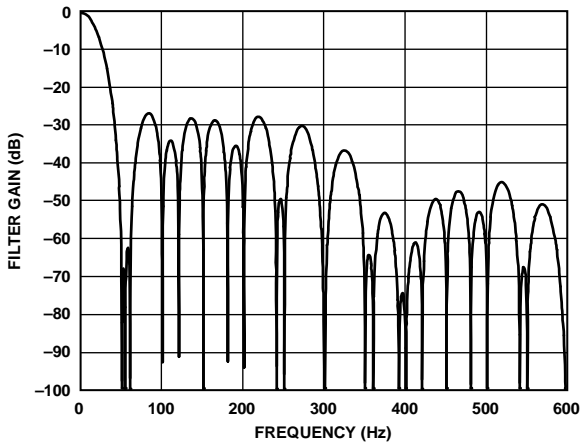

Figure 50. 25 SPS ODR, 40 ms Settling Time

25501-048

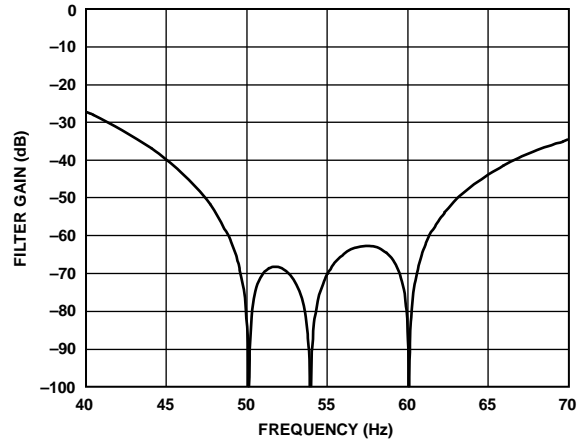

Figure 53. 25 SPS ODR, 40 ms Settling Time (40 Hz to 70 Hz)

25501-051

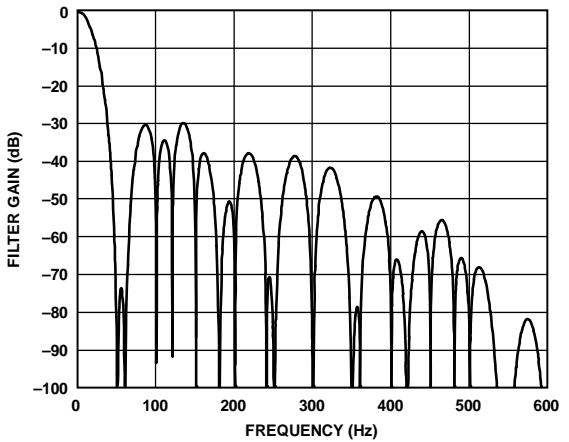

Figure 51. 20 SPS ODR, 50 ms Settling Time

25501-049

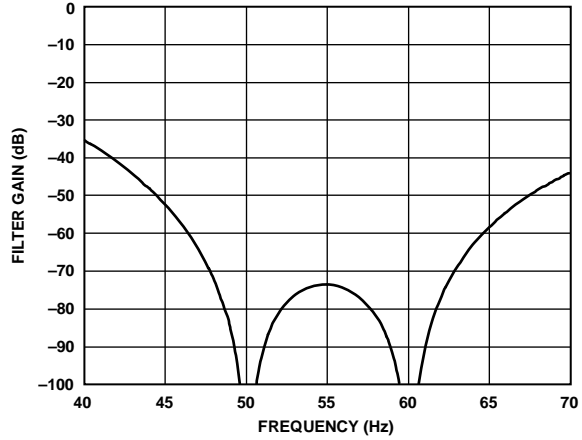

Figure 54. 20 SPS ODR, 50 ms Settling Time (40 Hz to 70 Hz)

25501-052

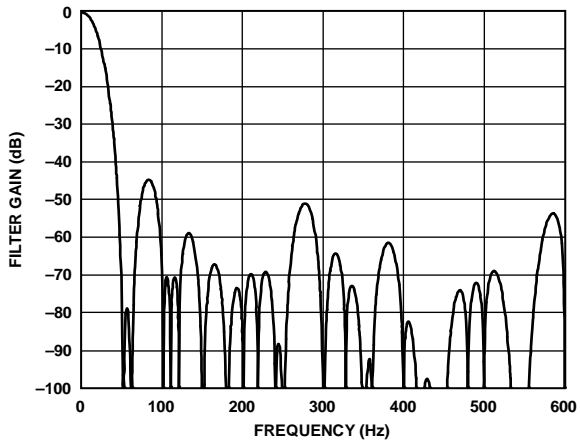

Figure 55. 16.667 SPS ODR, 60 ms Settling Time

25501-053

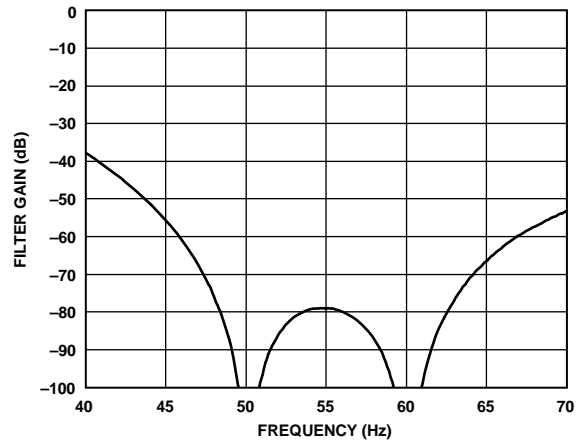

Figure 56. 16.667 SPS ODR, 60 ms Settling Time (40 Hz to 70 Hz)

25501-054

## OPERATING MODES

The AD4116 has a number of operating modes that can be set from the ADC mode register and interface mode register. These modes are as follows:

- Continuous conversion mode
- Continuous read mode
- Single conversion mode
- Standby mode
- Power-down mode
- Calibration modes (four)

### CONTINUOUS CONVERSION MODE

Continuous conversion mode is the default power-up mode. The AD4116 converts continuously, and the  $\overline{\text{RDY}}$  bit in the status register goes low each time a conversion is complete. If  $\overline{\text{CS}}$  is low, the  $\overline{\text{RDY}}$  output also goes low when a conversion is complete. To read a conversion, write to the communications register to indicate that the next operation is a read of the data register. When the data-word has been read from the data register,

the  $\overline{\text{DOUT/RDY}}$  pin goes high. The user can read this register additional times, if required. However, ensure that the data register is not being accessed at the completion of the next conversion. Otherwise, the new conversion word is lost.

When several channels are enabled, the ADC automatically sequences through the enabled channels, performing one conversion on each channel. When all the channels are converted, the sequence starts again with the first channel. The channels are converted in order from the lowest enabled channel to the highest enabled channel. The data register is updated as soon as each conversion is available. The  $\overline{\text{RDY}}$  output pulses low each time a conversion is available. The user can then read the conversion while the ADC converts the next enabled channel.

If the  $\text{DATA\_STAT}$  bit in the interface mode register is set to 1, the contents of the status register, along with the conversion data, are output each time the data register is read. The four LSBs of the status register indicates the channel to which the conversion corresponds.

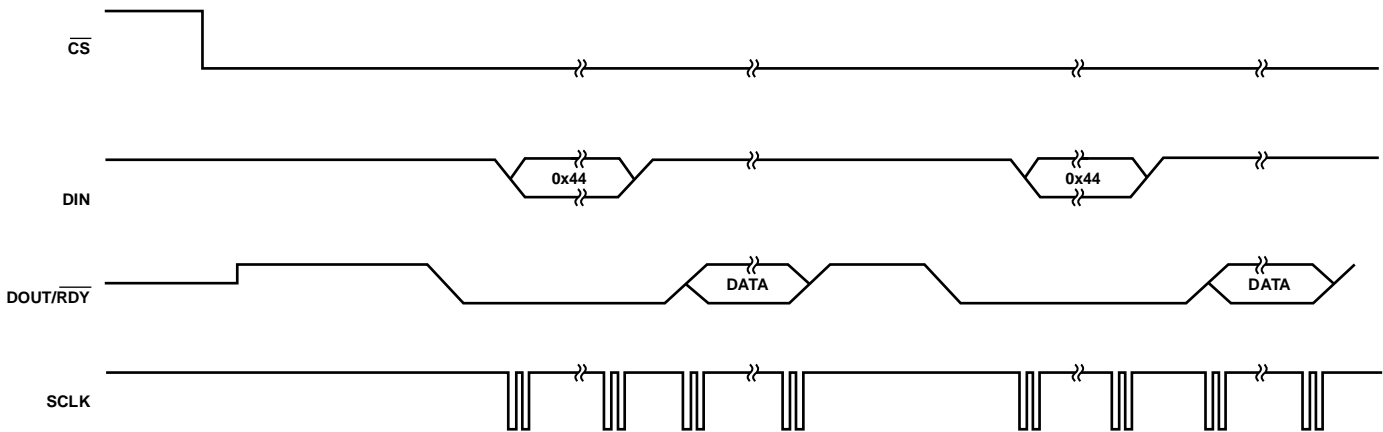

Figure 57. Continuous Conversion Mode

**CONTINUOUS READ MODE**

In continuous read mode, it is not required to write to the communications register before reading ADC data. Apply only the required number of SCLKs after the  $\overline{\text{RDY}}$  output goes low to indicate the end of a conversion. When the conversion is read, the  $\overline{\text{RDY}}$  output returns high until the next conversion is available. In this mode, the data can be read only once. Ensure that the data-word is read before the next conversion is complete. If the user has not read the conversion before the completion of the next conversion or if insufficient serial clocks are applied to the AD4116 to read the data-word, the serial output register is reset shortly before the next conversion is complete, and the new conversion is placed in the output serial register. The ADC must be configured for continuous conversion mode to use continuous read mode. To enable continuous read mode, set

the  $\text{CONTREAD}$  bit in the interface mode register. When this bit is set, the only serial interface operations possible are reads from the data register. To exit continuous read mode, issue a dummy read of the ADC data register command (0x44) while the  $\overline{\text{RDY}}$  output is low. Alternatively, apply a software reset (that is, 64 SCLKs with  $\overline{\text{CS}} = 0$  and  $\text{DIN} = 1$ ) to reset the ADC and all register contents. The dummy read and the software reset are the only commands that the interface recognizes after it is placed in continuous read mode. Hold  $\text{DIN}$  low in continuous read mode until an instruction is to be written to the device.

If multiple ADC channels are enabled, each channel is output in turn, with the status bits being appended to the data if the  $\text{DATA\_STAT}$  bit is set in the interface mode register. The four LSBs of the status register indicates the channel to which the conversion corresponds.

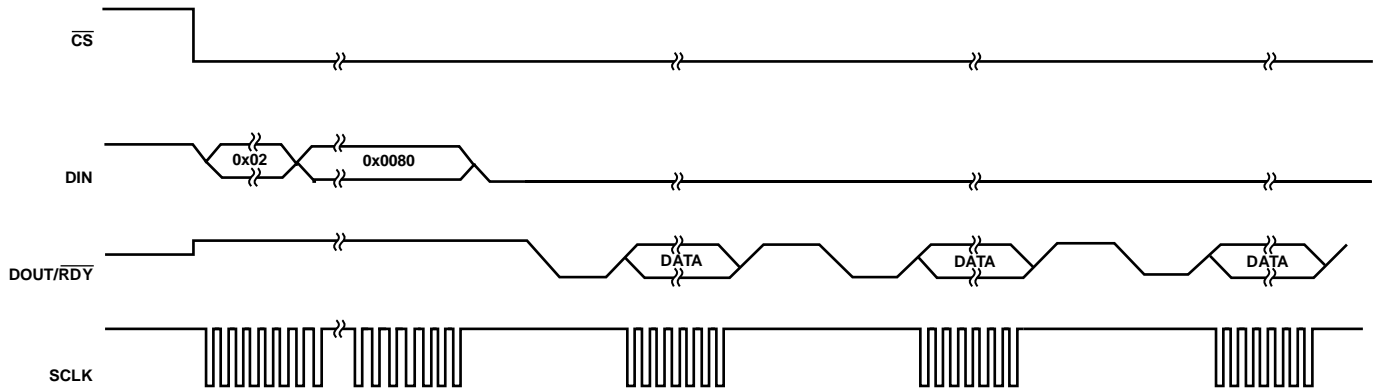

Figure 58. Continuous Read Mode

25501-056

**SINGLE CONVERSION MODE**

In single conversion mode, the AD4116 performs a single conversion and is placed in standby mode after the conversion is complete. The  $\overline{\text{RDY}}$  output goes low to indicate the completion of a conversion. When the data-word has been read from the data register, the  $\overline{\text{RDY}}$  output goes high. The data register can be read several times, if required, even when the  $\overline{\text{RDY}}$  output goes high.

If several channels are enabled, the ADC automatically sequences through the enabled channels and performs a conversion on each channel. When the first conversion is started, the  $\overline{\text{RDY}}$  output goes high and remains high until a valid conversion is available and CS is low. When the conversion is available, the

$\overline{\text{RDY}}$  output goes low. The ADC then selects the next channel and begins a conversion. The user can read the present conversion while the next conversion is being performed. When the next conversion is complete, the data register is updated; therefore, the user has a limited period in which to read the conversion. When the ADC has performed a single conversion on each of the selected channels, it returns to standby mode.

If the DATA\_STAT bit in the interface mode register is set to 1, the contents of the status register, along with the conversion, are output each time the data register is read. The four LSBs of the status register indicate the channel to which the conversion corresponds.

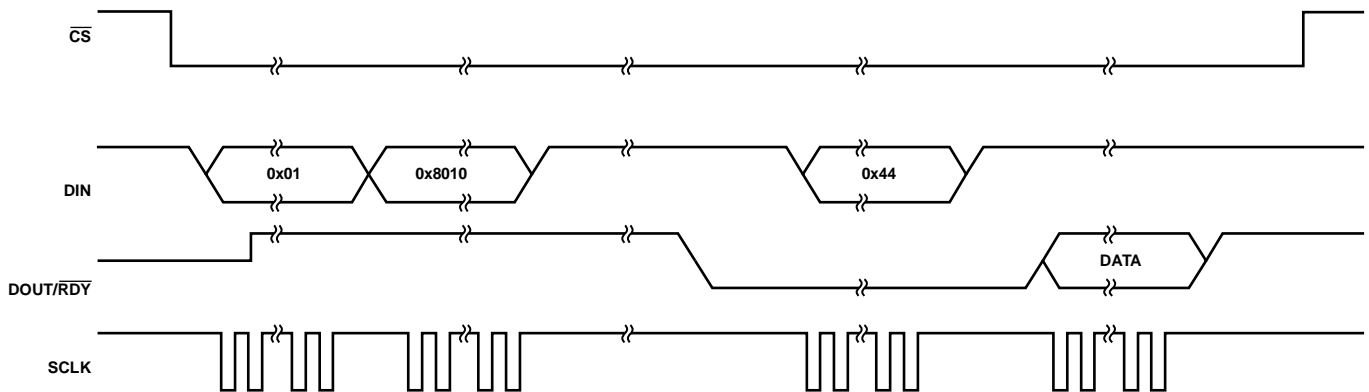

Figure 59. Single Conversion Mode

25501-057

## STANDBY AND POWER-DOWN MODES

In standby mode, most blocks are powered down. The LDO regulators remain active so that the registers maintain their contents. The crystal oscillator remains active if selected. To power down the clock in standby mode, set the CLOCKSEL bits in the ADC mode register to 00 (internal oscillator mode).

In power-down mode, all blocks are powered down, including the LDO regulators. All registers lose their contents, and the GPIO outputs are placed in three-state. To prevent accidental entry to power-down mode, the ADC must first be placed in standby mode. Exiting power-down mode requires 64 SCLKs with  $\overline{CS} = 0$  and  $DIN = 1$ , that is, a serial interface reset. A delay of 500  $\mu\text{s}$  is recommended before issuing a subsequent serial interface command to allow the LDO regulator to power up.

## CALIBRATION

The AD4116 allows a 2-point calibration to be performed to eliminate any offset and gain errors. The following four calibration modes are used to eliminate these offset and gain errors on a per setup basis:

- Internal zero-scale calibration mode
- Internal full-scale calibration mode
- System zero-scale calibration mode
- System full-scale calibration mode

Only one channel can be active during calibration. After each conversion, the ADC conversion result is scaled using the ADC calibration registers before being written to the data register.

The default value of the offset register is 0x800000, and the default value of the gain register is 0x5XXXX0. The following equations show the calculations that are used. In unipolar mode, the ideal relationship (that is, not taking into account the ADC gain error and offset error) is as follows:

For the voltage inputs,

$$Data = ((0.075 \times V_{IN}/V_{REF}) \times 2^{23} - (Offset - 0x800000)) \times (Gain/0x400000) \times 2$$

For the low level inputs,

$$Data = ((0.75 \times V_{ADCIN}/V_{REF}) \times 2^{23} - (Offset - 0x800000)) \times (Gain/0x400000) \times 2$$

In bipolar mode, the ideal relationship (that is, not taking into account the ADC gain error and offset error) is as follows:

For the voltage inputs,

$$Data = ((0.075 \times V_{IN}/V_{REF}) \times 2^{23} - (Offset - 0x800000)) \times (Gain/0x400000) + 0x800000$$

For the low level inputs,

$$Data = ((0.75 \times V_{ADCIN}/V_{REF}) \times 2^{23} - (Offset - 0x800000)) \times (Gain/0x400000) + 0x800000$$

To start a calibration, write the relevant value to the mode bits in the ADC mode register. The  $\overline{DOUT}/\overline{RDY}$  pin and the  $\overline{RDY}$  bit in the status register go high when the calibration initiates. When the calibration is complete, the contents of the corresponding offset or gain register are updated, the  $\overline{RDY}$  bit in the status register is reset, the  $\overline{RDY}$  output pin returns low (if  $\overline{CS}$  is low), and the AD4116 reverts to standby mode.

During an internal offset calibration, both modulator inputs are connected internally to the selected negative analog input pin. Therefore, it is necessary to ensure that the voltage on the selected negative analog input pin does not exceed the allowed limits and is free from excessive noise and interference. A full-scale, low level, input voltage automatically connects to the ADC input to perform an internal full-scale calibration.

However, for system calibrations, the system zero-scale (offset) and system full-scale (gain) voltages must be applied to the input pins before initiating the calibration modes. As a result, errors external to the AD4116 are removed.

The calibration range of the ADC gain for a system full-scale calibration on a voltage input is from  $3.75 \times V_{REF}$  to  $10.5 \times V_{REF}$ . However, if  $10.5 \times V_{REF}$  is greater than the absolute input voltage specification for the applied AVDD, use the specification as the upper limit instead of  $10.5 \times V_{REF}$  (see the Specifications section).

The calibration range of the ADC gain for a system full-scale calibration on a low level input is from  $0.4 \times V_{REF}$  to  $1.05 \times V_{REF}$ .

An internal zero-scale calibration only removes the offset error of the ADC core. It does not remove error from the resistive front end. A system zero-scale calibration reduces the offset error to the order of the noise on that channel.

From an operational point of view, treat a calibration like another ADC conversion. An offset calibration, if required, must always be performed before a full-scale calibration. Set the system software to monitor the  $\overline{RDY}$  bit in the status register or the  $\overline{RDY}$  output to determine the end of a calibration via a polling sequence or an interrupt driven routine. All calibrations require a time equal to the settling time of the selected filter and output data rate to be completed.

Any calibration can be performed at any output data rate. Using lower output data rates results in better calibration accuracy and is accurate for all output data rates. A new offset calibration is required for a given channel if the reference source for that channel is changed.

The AD4116 provides the user with access to the on-chip calibration registers, allowing the microprocessor to read the calibration coefficients of the device and to write its own calibration coefficients. A read or write of the offset and gain registers can be performed at any time except during an internal or self calibration.

## DIGITAL INTERFACE

The programmable functions of the AD4116 are accessible via the SPI. The SPI of the AD4116 consists of four signals:  $\overline{CS}$ , DIN, SCLK, and DOUT/RDY. The DIN line transfers data into the on-chip registers. The DOUT output accesses data from the on-chip registers. SCLK is the serial clock input for the device. All data transfers (either on DIN or on DOUT) occur with respect to the SCLK signal.

The DOUT/RDY pin also functions as a data ready signal, with the line going low if  $\overline{CS}$  is low when a new data-word is available in the data register. The DOUT/RDY pin is reset high when a read operation from the data register is complete. The RDY output also goes high before updating the data register to indicate when not to read from the device to ensure that a data read is not attempted while the register is being updated. Take care to avoid reading from the data register when RDY is about to go low. The best method to ensure that no data read occurs is to always monitor the RDY output. Start reading the data register as soon as RDY goes low, and ensure a sufficient SCLK rate, such that the read is completed before the next conversion result.  $\overline{CS}$  is used to select a device.  $\overline{CS}$  can be used to decode the AD4116 in systems where several components are connected to the serial bus.

Figure 2 and Figure 3 show timing diagrams for interfacing to the AD4116 using  $\overline{CS}$  to decode the device. Figure 2 shows the timing for a read operation from the AD4116, and Figure 3 shows the timing for a write operation to the AD4116. It is possible to read from the data register several times, even though the RDY output returns high after the first read operation.

However, take care to ensure that the read operations are completed before the next output update occurs. In continuous read mode, the data register can be read only once.

The serial interface can operate in 3-wire mode by tying  $\overline{CS}$  low. In this case, the SCLK, DIN, and DOUT/RDY lines are used to communicate with the AD4116. The end of the conversion can also be monitored using the RDY bit in the status register.

The SPI can be reset by writing 64 SCLKs with  $\overline{CS} = 0$  and  $DIN = 1$ . A reset returns the SPI to the state in which it expects a write to the communications register. This operation resets the contents of all registers to their power-on values. Following a reset, allow a period of 500  $\mu$ s before addressing the SPI.

### CHECKSUM PROTECTION

The AD4116 has a checksum mode that can improve interface robustness. Using the checksum mode ensures that only valid data is written to a register and allows data read from a register to be validated. If an error occurs during a register write, the

CRC\_ERROR bit is set in the status register. However, to ensure that the register write is completed. It is important to read back the register and verify the checksum.

For CRC checksum calculations during a write operation, the following polynomial is always used:

$$x^8 + x^2 + x + 1$$

During read operations, the user can select between this polynomial and a similar exclusive OR (XOR) function. The XOR function requires less time to process on the host microcontroller than the polynomial-based checksum. The CRC\_EN bits in the interface mode register enable and disable the checksum and allow the user to select between the polynomial check and the simple XOR check.

The checksum is appended to the end of each read and write transaction. The checksum calculation for the write transaction is calculated using the 8-bit command word and the 8-bit to 24-bit data. For a read transaction, the checksum is calculated using the command word and the 8-bit to 32-bit data output. Figure 60 and Figure 61 show SPI write and read transactions, respectively.

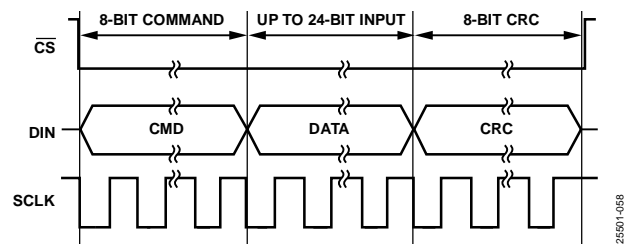

Figure 60. SPI Write Transaction with CRC

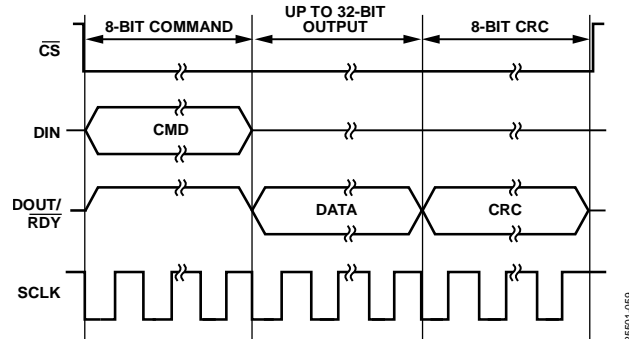

Figure 61. SPI Read Transaction with CRC

If checksum protection is enabled when continuous read mode is active, there is an implied read data command of 0x44 before every data transmission that must be accounted for when calculating the checksum value. The checksum protection ensures a nonzero checksum value even if the ADC data equals 0x000000.



**CRC CALCULATION**

**Polynomial**

The checksum, which is eight bits wide, is generated using the following polynomial:

$$x^8 + x^2 + x + 1$$

To generate the checksum, the data is left shifted by eight bits to create a number ending in eight Logic 0s. The polynomial is aligned so that its MSB is adjacent to the leftmost Logic 1 of the data. An exclusive OR (XOR) function is applied to the data to produce a new, shorter number. The polynomial is again aligned

so that its MSB is adjacent to the leftmost Logic 1 of the new result, and the procedure is repeated. This process is repeated until the original data is reduced to a value less than the polynomial. This value is the 8-bit checksum.

**Example of a Polynomial CRC Calculation—24-Bit Word: 0x654321 (Eight Command Bits and 16-Bit Data)**

An example of generating the 8-bit checksum using the polynomial based checksum follows:

|                       |                                  |                         |
|-----------------------|----------------------------------|-------------------------|
| Initial value         | 011001010100001100100001         |                         |
|                       | 01100101010000110010000100000000 | left shifted eight bits |
| $x^8 + x^2 + x + 1 =$ | 100000111                        | polynomial              |
|                       | 100100100000110010000100000000   | XOR result              |
|                       | 100000111                        | polynomial              |
|                       | 1000110001100100001000000000     | XOR result              |
|                       | 100000111                        | polynomial              |
|                       | 111111100100001000000000         | XOR result              |
|                       | 100000111                        | polynomial value        |
|                       | 1111101110000100000000           | XOR result              |
|                       | 100000111                        | polynomial value        |
|                       | 1111000000001000000000           | XOR result              |
|                       | 100000111                        | polynomial value        |
|                       | 11100111000100000000             | XOR result              |
|                       | 100000111                        | polynomial value        |
|                       | 11001001001000000000             | XOR result              |
|                       | 100000111                        | polynomial value        |
|                       | 100101010100000000               | XOR result              |
|                       | 100000111                        | polynomial value        |
|                       | 1011011000000000                 | XOR result              |
|                       | 100000111                        | polynomial value        |
|                       | 11010110000000                   | XOR result              |
|                       | 100000111                        | polynomial value        |
|                       | 101010110000                     | XOR result              |
|                       | 100000111                        | polynomial value        |
|                       | 1010001000                       | XOR result              |
|                       | 100000111                        | polynomial value        |
|                       | 10000110                         | checksum = 0x86.        |

**XOR Calculation**

The checksum, which is eight bits wide, is generated by splitting the data into bytes and then performing an XOR of the bytes.

**Example of an XOR Calculation—24-Bit Word: 0x654321  
(Eight Command Bits and 16-Bit Data)**

Using the previous polynomial example, divide the checksum into three bytes (0x65, 0x43, and 0x21) which results in the following XOR calculation:

|          |            |
|----------|------------|
| 01100101 | 0x65       |
| 01000011 | 0x43       |
| 00100110 | XOR result |
| 00100001 | 0x21       |
| 00000111 | CRC        |

## INTEGRATED FUNCTIONS

The AD4116 has a number of integrated functions.

### GENERAL-PURPOSE I/O

The AD4116 has two general-purpose digital input and output pins (GPIO0 and GPIO1) and two general-purpose digital output pins (GPO2 and GPO3). As the naming convention suggests, the GPIO0 and GPIO1 pins can be configured as inputs or outputs, but the GPO2 and GPO3 pins are outputs only. The GPIOx and GPOx pins are enabled using the following bits in the GPIOCON register: IP\_EN0 and IP\_EN1 (or OP\_EN0 and OP\_EN1) for GPIO0 and GPIO1 and OP\_EN2\_3 for GPO2 and GPO3.

When the GPIO0 or GPIO1 pin is enabled as an input, the logic level at the pin is contained in the GP\_DATA0 or GP\_DATA1 bit, respectively. When the GPIO0, GPIO1, GPO2, or GPO3 pin is enabled as an output, the GP\_DATA0, GP\_DATA1, GP\_DATA2, or GP\_DATA3 bit, respectively, determines the logic level output at the pin. The logic levels for these pins are referenced to AVDD and AVSS; therefore, outputs have an amplitude of either 5 V or depending on the AVDD – AVSS voltage.

The ERROR pin can also be used as a general-purpose output if the ERR\_EN bits in the GPIOCON register are set to 11. In this configuration, the ERR\_DAT bit in the GPIOCON register determines the logic level output at the ERROR pin. The logic level for the pin is referenced to IOVDD and DGND, and the ERROR pin has an active pull-up.

### EXTERNAL MULTIPLEXER CONTROL

If an external multiplexer is used to increase the channel count, the multiplexer logic pins can be controlled using the AD4116 GPIOx and GPOx pins. When the MUX\_IO bit is set in the GPIOCON register (Address 0x06, Bit 12), the timing of the GPIOx pins is controlled by the ADC; therefore, the channel change is synchronized with the ADC, eliminating any need for external synchronization.

### DELAY

It is possible to insert a programmable delay before the AD4116 begins to take samples. This delay allows an external amplifier or multiplexer to settle and can also alleviate the specification requirements for the external amplifier or multiplexer. Eight programmable settings, ranging from 0  $\mu$ s to 4 ms, can be set using the delay bits in the ADC mode register (Register 0x01, Bits[10:8]).

### 16-BIT/24-BIT CONVERSION

By default, the AD4116 generates 24-bit conversions. However, the width of the conversions can be reduced to 16 bits. Setting Bit WL16 in the interface mode register to 1 rounds all data conversions to 16 bits. Clearing this bit sets the width of the data conversions to 24 bits.

### DOUT\_RESET

The SPI uses a shared DOUT/ $\overline{\text{RDY}}$  pin. By default, this pin outputs the  $\overline{\text{RDY}}$  signal. During a data read, this pin outputs the data from the register being read. After the read is complete, the pin reverts to outputting the  $\overline{\text{RDY}}$  signal after a short, fixed period of time ( $t_7$ ). However, this time may be too short for some microcontrollers and can be extended until the  $\overline{\text{CS}}$  pin is brought high by setting the DOUT\_RESET bit in the interface mode register to 1. This setting means that  $\overline{\text{CS}}$  must frame each read operation and complete the SPI transaction.

### SYNCHRONIZATION

#### Normal Synchronization

When the SYNC\_EN bit in the GPIOCON register is set to 1, the  $\overline{\text{SYNC}}$  pin functions as a synchronization pin. The  $\overline{\text{SYNC}}$  input allows the user to reset the modulator and the digital filter without affecting any of the setup conditions on the device. This reset allows the user to start gathering samples of the analog input from a known point in time, that is, the rising edge of  $\overline{\text{SYNC}}$ . This pin must be low for at least one master clock cycle to ensure that synchronization occurs. If multiple channels are enabled, the sequencer is reset to the first enabled channel.

If multiple AD4116 devices are operated from a common master clock, they can be synchronized so that their data registers are updated simultaneously. Synchronization is normally done after each AD4116 has performed its own calibration or has calibration coefficients loaded into its calibration registers. A falling edge on the  $\overline{\text{SYNC}}$  pin resets the digital filter and the analog modulator and places the AD4116 into a consistent known state. While the  $\overline{\text{SYNC}}$  pin is low, the AD4116 is maintained in this state. On the  $\overline{\text{SYNC}}$  rising edge, the modulator and filter are taken out of this reset state, and on the next master clock edge, the device starts to gather input samples again.

The device is taken out of reset on the master clock falling edge following the  $\overline{\text{SYNC}}$  low-to-high transition. Therefore, when multiple devices are being synchronized, take the  $\overline{\text{SYNC}}$  pin high on the master clock rising edge to ensure that all devices begin sampling on the master clock falling edge. If the  $\overline{\text{SYNC}}$  pin is not taken high in sufficient time, it is possible to have a difference of one master clock cycle between the devices, that is, the instant at which conversions are available differs from device to device by a maximum of one master clock cycle.

The  $\overline{\text{SYNC}}$  input can also be used as a start conversion command for a single channel when in normal synchronization mode. In this mode, the rising edge of the  $\overline{\text{SYNC}}$  input starts a conversion, and the falling edge of the  $\overline{\text{RDY}}$  output indicates when the conversion is complete. The settling time of the filter is required for each data register update. After the conversion is complete, bring the  $\overline{\text{SYNC}}$  input low in preparation for the next conversion start signal.

### Alternate Synchronization

In alternate synchronization mode, the  $\overline{\text{SYNC}}$  input operates as a start conversion command when several channels of the AD4116 are enabled. Setting the ALT\_SYNC bit in the interface mode register to 1 enables an alternate synchronization scheme. When the  $\overline{\text{SYNC}}$  input is taken low, the ADC completes the conversion on the enabled channel, selects the next channel in the sequence, and then waits until the  $\overline{\text{SYNC}}$  input is taken high to start the conversion. The  $\overline{\text{RDY}}$  output goes low when the conversion is complete on the current channel, and the data register is updated with the corresponding conversion. Therefore, the  $\overline{\text{SYNC}}$  input does not interfere with the sampling on the currently selected channel but allows the user to control the instant at which the conversion begins on the next channel in the sequence.

Alternate synchronization mode can be used only when several channels are enabled. It is not recommended to use this mode when a single channel is enabled.

### ERROR FLAGS

The status register contains three error bits (ADC\_ERROR, CRC\_ERROR, and REG\_ERROR) that flag errors with the ADC conversion, errors with the CRC check, and errors caused by changes in the registers, respectively. In addition, the  $\overline{\text{ERROR}}$  output can indicate that an error has occurred.

#### ADC\_ERROR

The ADC\_ERROR bit in the status register flags any errors that occur during the conversion process. The flag is set when an overrange or underrange result is output from the ADC. The ADC also outputs all 0s or all 1s when an undervoltage or overvoltage occurs. This flag is reset only when the overvoltage or undervoltage is removed. This flag is not reset by a read of the data register.

#### CRC\_ERROR

If the CRC value that accompanies a write operation does not correspond with the information sent, the CRC\_ERROR flag is set. The flag is reset as soon as the status register is explicitly read.

#### REG\_ERROR

The REG\_ERROR flag is used in conjunction with the REG\_CHECK bit in the interface mode register. When the REG\_CHECK bit is set, the AD4116 monitors the values in the on-chip registers. If a bit changes, the REG\_ERROR bit is set to 1. Therefore, for writes to the on-chip registers, set the REG\_CHECK bit to 0. When the registers are updated, the REG\_CHECK bit can be set to 1. The AD4116 calculates a checksum of the on-chip registers. If one of the register values has changed, the REG\_ERROR bit is set to 1. If an error is flagged, the REG\_CHECK bit must be set to 0 to clear the REG\_ERROR bit in the status register. The register check function does not monitor the data register, status register, or interface mode register.

### $\overline{\text{ERROR}}$ Input/Output

The  $\overline{\text{ERROR}}$  pin functions as an error input and output pin or as a general-purpose output pin. The ERR\_EN bits in the GPIOCON register determine the function of the pin.

When the ERR\_EN bits are set to 10, the  $\overline{\text{ERROR}}$  pin functions as an open-drain error output. The three error bits in the status register (ADC\_ERROR, CRC\_ERROR, and REG\_ERROR) are OR'ed, inverted, and mapped to the  $\overline{\text{ERROR}}$  output. Therefore, the  $\overline{\text{ERROR}}$  output indicates that an error has occurred. The status register must be read to identify the error source.

When the ERR\_EN bits are set to 01, the  $\overline{\text{ERROR}}$  pin functions as an error input. The error output of another component can be connected to the AD4116  $\overline{\text{ERROR}}$  input so that the AD4116 indicates when an error occurs on either itself or the external component. The value on the  $\overline{\text{ERROR}}$  input is inverted and OR'ed with the errors from the ADC conversion, and the result is indicated via the ADC\_ERROR bit in the status register. The value of the  $\overline{\text{ERROR}}$  input is reflected in the ERR\_DAT bit in the GPIOCON register.

The  $\overline{\text{ERROR}}$  input and output is disabled when the ERR\_EN bits are set to 00. When the ERR\_EN bits are set to 11, the  $\overline{\text{ERROR}}$  pin operates as a general-purpose output where the ERR\_DAT bit is used to determine the logic level of the pin.

### DATA\_STAT

The contents of the status register can be appended to each conversion on the AD4116 using the DATA\_STAT bit in the IFMODE register. This function is useful if several channels are enabled. Each time a conversion is output, the contents of the status register are appended. The four LSBs of the status register indicate to which channel the conversion corresponds. In addition, the user can determine if any errors are being flagged by the error bits.

### IOSTRENGTH

The SPI can operate with a power supply as low as 2 V. However, at this low voltage, the DOUT/ $\overline{\text{RDY}}$  pin may not have sufficient drive strength if there is moderate parasitic capacitance on the board or if the SCLK frequency is high. The IOSTRENGTH bit in the interface mode register increases the drive strength of the DOUT/ $\overline{\text{RDY}}$  pin.

**INTERNAL TEMPERATURE SENSOR**

The AD4116 has an integrated temperature sensor. The temperature sensor can be used as a guide for the ambient temperature at which the device is operating. The ambient temperature can be used for diagnostic purposes or as an indicator of when the application circuit must rerun a calibration routine to take into account a shift in operating temperature. The temperature sensor is selected using the multiplexer and is selected in the same way as an input channel.

The temperature sensor requires that the input buffers be enabled on both inputs and the internal reference be enabled.

To use the temperature sensor, the first step is to calibrate the device in a known temperature (25°C) and take a conversion as a reference point. The temperature sensor has a nominal sensitivity of 477  $\mu\text{V}/\text{K}$ . The difference in this ideal slope and the slope measured can calibrate the temperature sensor. The temperature sensor is specified with a  $\pm 2^\circ\text{C}$  typical accuracy after calibration at 25°C. To calculate the temperature, use the following equation:

$$\text{Temperature } (^\circ\text{C}) = (\text{Conversion Result} \div 477 \mu\text{V}) - 273.15$$

## APPLICATIONS INFORMATION

### GROUNDING AND LAYOUT

The inputs and reference inputs are differential and, therefore, most of the voltages in the analog modulator are common-mode voltages. The high common-mode rejection of the device removes common-mode noise on these inputs. The analog and digital supplies to the AD4116 are independent and separately pinned out to minimize coupling between the analog and digital sections of the device. The digital filter provides rejection of broadband noise on the power supplies, except at integer multiples of the master clock frequency.

The digital filter also removes noise from the analog inputs and reference inputs, provided that these noise sources do not saturate the analog modulator. As a result, the AD4116 is more immune to noise interference than a conventional high resolution converter. However, because the resolution of the AD4116 is high and the noise levels from the converter are so low, take care with regard to grounding and layout.

The PCB that houses the ADC must be designed so that the analog and digital sections are separated and confined to certain areas of the board. A minimum etch technique is generally best for ground planes because it results in the best shielding.

In any layout, the user must keep in mind the flow of currents in the system, ensuring that the paths for all return currents are as close as possible to the paths the currents took to reach their destinations.

Avoid running digital lines under the device because this couples noise onto the die and allows the analog ground plane

to run under the AD4116 to prevent noise coupling. The power supply lines to the AD4116 must use as wide a trace as possible to provide low impedance paths and reduce glitches on the power supply line. Shield fast switching signals like clocks with digital ground to prevent radiating noise to other sections of the board and never run clock signals near the inputs. Avoid crossover of digital and analog signals. Run traces on opposite sides of the board at right angles to each other. This layout reduces the effects of feedthrough on the board. A microstrip technique is by far the best but is not always possible with a double-sided board. In this technique, the component side of the board is dedicated to ground planes, whereas signals are placed on the solder side.

Proper decoupling is important when using high resolution ADCs. The AD4116 has two power supply pins: AVDD and IOVDD. The AVDD pin is referenced to AVSS, and the IOVDD pin is referenced to DGND. Decouple AVDD with a 10  $\mu\text{F}$  tantalum capacitor in parallel with a 0.1  $\mu\text{F}$  capacitor to AVSS on each pin. Place the 0.1  $\mu\text{F}$  capacitor as near as possible to the device on each supply, ideally right up against the device. Decouple IOVDD with a 10  $\mu\text{F}$  tantalum capacitor, in parallel with a 0.1  $\mu\text{F}$  capacitor to DGND. Decouple all inputs to AVSS. If an external reference is used, decouple the REF+ and REF- pins to AVSS.

The AD4116 also has two on-board LDO regulator outputs: one that regulates the AVDD supply, and one that regulates the IOVDD supply. For the REGCAPA pin, it is recommended that 1  $\mu\text{F}$  and 0.1  $\mu\text{F}$  capacitors to AVSS be used. Similarly, for the REGCAPD pin, it is recommended that 1  $\mu\text{F}$  and 0.1  $\mu\text{F}$  capacitors to DGND be used.

## REGISTER SUMMARY

Table 24. Register Summary

| Register | Name     | Bits    | Bit 7                 | Bit 6       | Bit 5     | Bit 4     | Bit 3      | Bit 2    | Bit 1        | Bit 0      | Reset <sup>1</sup> | R/W      |   |
|----------|----------|---------|-----------------------|-------------|-----------|-----------|------------|----------|--------------|------------|--------------------|----------|---|
| 0x00     | COMMS    | [7:0]   | WEN                   | R/W         | RA        |           |            |          |              |            | 0x00               | W        |   |
| 0x00     | Status   | [7:0]   | RDY                   | ADC_ERROR   | CRC_ERROR | REG_ERROR | Channel    |          |              |            | 0x80               | R        |   |
| 0x01     | ADCMODE  | [15:8]  | REF_EN                | Reserved    | SING_CYC  | Reserved  |            | Delay    |              |            | 0x2000             | R/W      |   |
|          |          | [7:0]   | Reserved              | Mode        |           |           | CLOCKSEL   |          | Reserved     |            |                    |          |   |
| 0x02     | IFMODE   | [15:8]  | Reserved              |             |           | ALT_SYNC  | IOSTRENGTH | Reserved |              | DOUT_RESET | 0x0000             | R/W      |   |
|          |          | [7:0]   | CONTREAD              | DATA_STAT   | REG_CHECK | Reserved  | CRC_EN     |          | Reserved     | WL16       |                    |          |   |
| 0x03     | REGCHECK | [23:16] | REGISTER_CHECK[23:16] |             |           |           |            |          |              |            |                    | 0x000000 | R |
|          |          | [15:8]  | REGISTER_CHECK[15:8]  |             |           |           |            |          |              |            |                    |          |   |
|          |          | [7:0]   | REGISTER_CHECK[7:0]   |             |           |           |            |          |              |            |                    |          |   |
| 0x04     | Data     | [23:0]  | Data[23:16]           |             |           |           |            |          |              |            |                    | 0x000000 | R |
|          |          | [15:8]  | Data[15:8]            |             |           |           |            |          |              |            |                    |          |   |
|          |          | [7:0]   | Data[7:0]             |             |           |           |            |          |              |            |                    |          |   |
| 0x06     | GPIOCON  | [15:8]  | Reserved              |             | OP_EN2_3  | MUX_IO    | SYNC_EN    | ERR_EN   |              | ERR_DAT    | 0x0800             | R/W      |   |
|          |          | [7:0]   | GP_DATA3              | GP_DATA2    | IP_EN1    | IP_EN0    | OP_EN1     | OP_EN0   | GP_DATA1     | GP_DATA0   |                    |          |   |
| 0x07     | ID       | [15:8]  | ID[15:8]              |             |           |           |            |          |              |            |                    | 0x34DX   | R |
|          |          | [7:0]   | ID[7:0]               |             |           |           |            |          |              |            |                    |          |   |
| 0x10     | CH0      | [15:8]  | CH_EN0                | SETUP_SEL0  |           |           | Reserved   |          | INPUT0[9:8]  |            | 0x8001             | R/W      |   |
|          |          | [7:0]   | INPUT0[7:0]           |             |           |           |            |          |              |            |                    |          |   |
| 0x11     | CH1      | [15:8]  | CH_EN1                | SETUP_SEL1  |           |           | Reserved   |          | INPUT1[9:8]  |            | 0x0001             | R/W      |   |
|          |          | [7:0]   | INPUT1[7:0]           |             |           |           |            |          |              |            |                    |          |   |
| 0x12     | CH2      | [15:8]  | CH_EN2                | SETUP_SEL2  |           |           | Reserved   |          | INPUT2[9:8]  |            | 0x0001             | R/W      |   |
|          |          | [7:0]   | INPUT2[7:0]           |             |           |           |            |          |              |            |                    |          |   |
| 0x13     | CH3      | [15:8]  | CH_EN3                | SETUP_SEL3  |           |           | Reserved   |          | INPUT3[9:8]  |            | 0x0001             | R/W      |   |
|          |          | [7:0]   | INPUT3[7:0]           |             |           |           |            |          |              |            |                    |          |   |
| 0x14     | CH4      | [15:8]  | CH_EN4                | SETUP_SEL4  |           |           | Reserved   |          | INPUT4[9:8]  |            | 0x0001             | R/W      |   |
|          |          | [7:0]   | INPUT4[7:0]           |             |           |           |            |          |              |            |                    |          |   |
| 0x15     | CH5      | [15:8]  | CH_EN5                | SETUP_SEL5  |           |           | Reserved   |          | INPUT5[9:8]  |            | 0x0001             | R/W      |   |
|          |          | [7:0]   | INPUT5[7:0]           |             |           |           |            |          |              |            |                    |          |   |
| 0x16     | CH6      | [15:8]  | CH_EN6                | SETUP_SEL6  |           |           | Reserved   |          | INPUT6[9:8]  |            | 0x0001             | R/W      |   |
|          |          | [7:0]   | INPUT6[7:0]           |             |           |           |            |          |              |            |                    |          |   |
| 0x17     | CH7      | [15:8]  | CH_EN7                | SETUP_SEL7  |           |           | Reserved   |          | INPUT7[9:8]  |            | 0x0001             | R/W      |   |
|          |          | [7:0]   | INPUT7[7:0]           |             |           |           |            |          |              |            |                    |          |   |
| 0x18     | CH8      | [15:8]  | CH_EN8                | SETUP_SEL8  |           |           | Reserved   |          | INPUT8[9:8]  |            | 0x0001             | R/W      |   |
|          |          | [7:0]   | INPUT8[7:0]           |             |           |           |            |          |              |            |                    |          |   |
| 0x19     | CH9      | [15:8]  | CH_EN9                | SETUP_SEL9  |           |           | Reserved   |          | INPUT9[9:8]  |            | 0x0001             | R/W      |   |
|          |          | [7:0]   | INPUT9[7:0]           |             |           |           |            |          |              |            |                    |          |   |
| 0x1A     | CH10     | [15:8]  | CH_EN10               | SETUP_SEL10 |           |           | Reserved   |          | INPUT10[9:8] |            | 0x0001             | R/W      |   |
|          |          | [7:0]   | Input10[7:0]          |             |           |           |            |          |              |            |                    |          |   |
| 0x1B     | CH11     | [15:8]  | CH_EN11               | SETUP_SEL11 |           |           | Reserved   |          | INPUT11[9:8] |            | 0x0001             | R/W      |   |
|          |          | [7:0]   | INPUT11[7:0]          |             |           |           |            |          |              |            |                    |          |   |
| 0x1C     | CH12     | [15:8]  | CH_EN12               | SETUP_SEL12 |           |           | Reserved   |          | INPUT12[9:8] |            | 0x0001             | R/W      |   |
|          |          | [7:0]   | INPUT12[7:0]          |             |           |           |            |          |              |            |                    |          |   |
| 0x1D     | CH13     | [15:8]  | CH_EN13               | SETUP_SEL13 |           |           | Reserved   |          | INPUT13[9:8] |            | 0x0001             | R/W      |   |
|          |          | [7:0]   | INPUT13[7:0]          |             |           |           |            |          |              |            |                    |          |   |
| 0x1E     | CH14     | [15:8]  | CH_EN14               | SETUP_SEL14 |           |           | Reserved   |          | INPUT14[9:8] |            | 0x0001             | R/W      |   |
|          |          | [7:0]   | INPUT14[7:0]          |             |           |           |            |          |              |            |                    |          |   |
| 0x1F     | CH15     | [15:8]  | CH_EN15               | SETUP_SEL15 |           |           | Reserved   |          | INPUT15[9:8] |            | 0x0001             | R/W      |   |
|          |          | [7:0]   | INPUT15[7:0]          |             |           |           |            |          |              |            |                    |          |   |

| Register | Name      | Bits   | Bit 7      | Bit 6    | Bit 5    | Bit 4         | Bit 3      | Bit 2    | Bit 1    | Bit 0  | Reset <sup>1</sup> | R/W |
|----------|-----------|--------|------------|----------|----------|---------------|------------|----------|----------|--------|--------------------|-----|
| 0x20     | SETUPCON0 | [15:8] | Reserved   |          |          | BI_UNIPOLAR0  | REFBUF0+   | REFBUF0- | INBUF0   |        | 0x1000             | R/W |
|          |           | [7:0]  | Reserved   |          | REF_SEL0 |               | Reserved   |          |          |        |                    |     |
| 0x21     | SETUPCON1 | [15:8] | Reserved   |          |          | BI_UNIPOLAR1  | REFBUF1+   | REFBUF1- | INBUF1   |        | 0x1000             | R/W |
|          |           | [7:0]  | Reserved   |          | REF_SEL1 |               | Reserved   |          |          |        |                    |     |
| 0x22     | SETUPCON2 | [15:8] | Reserved   |          |          | BI_UNIPOLAR2  | REFBUF2+   | REFBUF2- | INBUF2   |        | 0x1000             | R/W |
|          |           | [7:0]  | Reserved   |          | REF_SEL2 |               | Reserved   |          |          |        |                    |     |
| 0x23     | SETUPCON3 | [15:8] | Reserved   |          |          | BI_UNIPOLAR3  | REFBUF3+   | REFBUF3- | INBUF3   |        | 0x1000             | R/W |
|          |           | [7:0]  | Reserved   |          | REF_SEL3 |               | Reserved   |          |          |        |                    |     |
| 0x24     | SETUPCON4 | [15:8] | Reserved   |          |          | BI_UNIPOLAR4  | REFBUF4+   | REFBUF4- | INBUF4   |        | 0x1000             | R/W |
|          |           | [7:0]  | Reserved   |          | REF_SEL4 |               | Reserved   |          |          |        |                    |     |
| 0x25     | SETUPCON5 | [15:8] | Reserved   |          |          | BI_UNIPOLAR5  | REFBUF5+   | REFBUF5- | INBUF5   |        | 0x1000             | R/W |
|          |           | [7:0]  | Reserved   |          | REF_SEL5 |               | Reserved   |          |          |        |                    |     |
| 0x26     | SETUPCON6 | [15:8] | Reserved   |          |          | BI_UNIPOLAR6  | REFBUF6+   | REFBUF6- | INBUF6   |        | 0x1000             | R/W |
|          |           | [7:0]  | Reserved   |          | REF_SEL6 |               | Reserved   |          |          |        |                    |     |
| 0x27     | SETUPCON7 | [15:8] | Reserved   |          |          | BI_UNIPOLAR7  | REFBUF7+   | REFBUF7- | INBUF7   |        | 0x1000             | R/W |
|          |           | [7:0]  | Reserved   |          | REF_SEL7 |               | Reserved   |          |          |        |                    |     |
| 0x28     | FILTCON0  | [15:8] | SINC3_MAP0 | Reserved |          |               | ENHFILTEN0 | ENHFILT0 |          | 0x0500 | R/W                |     |
|          |           | [7:0]  | Reserved   | ORDER0   |          | ODR0          |            |          |          |        |                    |     |
| 0x29     | FILTCON1  | [15:8] | SINC3_MAP1 | Reserved |          |               | ENHFILTEN1 | ENHFILT1 |          | 0x0500 | R/W                |     |
|          |           | [7:0]  | Reserved   | ORDER1   |          | ODR1          |            |          |          |        |                    |     |
| 0x2A     | FILTCON2  | [15:8] | SINC3_MAP2 | Reserved |          |               | ENHFILTEN2 | ENHFILT2 |          | 0x0500 | R/W                |     |
|          |           | [7:0]  | Reserved   | ORDER2   |          | ODR2          |            |          |          |        |                    |     |
| 0x2B     | FILTCON3  | [15:8] | SINC3_MAP3 | Reserved |          |               | ENHFILTEN3 | ENHFILT3 |          | 0x0500 | R/W                |     |
|          |           | [7:0]  | Reserved   | ORDER3   |          | ODR3          |            |          |          |        |                    |     |
| 0x2C     | FILTCON4  | [15:8] | SINC3_MAP4 | Reserved |          |               | ENHFILTEN4 | ENHFILT4 |          | 0x0500 | R/W                |     |
|          |           | [7:0]  | Reserved   | ORDER4   |          | ODR4          |            |          |          |        |                    |     |
| 0x2D     | FILTCON5  | [15:8] | SINC3_MAP5 | Reserved |          |               | ENHFILTEN5 | ENHFILT5 |          | 0x0500 | R/W                |     |
|          |           | [7:0]  | Reserved   | ORDER5   |          | ODR5          |            |          |          |        |                    |     |
| 0x2E     | FILTCON6  | [15:8] | SINC3_MAP6 | Reserved |          |               | ENHFILTEN6 | ENHFILT6 |          | 0x0500 | R/W                |     |
|          |           | [7:0]  | Reserved   | ORDER6   |          | ODR6          |            |          |          |        |                    |     |
| 0x2F     | FILTCON7  | [15:8] | SINC3_MAP7 | Reserved |          |               | ENHFILTEN7 | ENHFILT7 |          | 0x0500 | R/W                |     |
|          |           | [7:0]  | Reserved   | ORDER7   |          | ODR7          |            |          |          |        |                    |     |
| 0x30     | OFFSET0   | [23:0] |            |          |          | OFFSET0[23:0] |            |          | 0x800000 | R/W    |                    |     |
| 0x31     | OFFSET1   | [23:0] |            |          |          | OFFSET1[23:0] |            |          | 0x800000 | R/W    |                    |     |
| 0x32     | OFFSET2   | [23:0] |            |          |          | OFFSET2[23:0] |            |          | 0x800000 | R/W    |                    |     |
| 0x33     | OFFSET3   | [23:0] |            |          |          | OFFSET3[23:0] |            |          | 0x800000 | R/W    |                    |     |
| 0x34     | OFFSET4   | [23:0] |            |          |          | OFFSET4[23:0] |            |          | 0x800000 | R/W    |                    |     |
| 0x35     | OFFSET5   | [23:0] |            |          |          | OFFSET5[23:0] |            |          | 0x800000 | R/W    |                    |     |
| 0x36     | OFFSET6   | [23:0] |            |          |          | OFFSET6[23:0] |            |          | 0x800000 | R/W    |                    |     |
| 0x37     | OFFSET7   | [23:0] |            |          |          | OFFSET7[23:0] |            |          | 0x800000 | R/W    |                    |     |
| 0x38     | GAIN0     | [23:0] |            |          |          | GAIN0[23:0]   |            |          | 0x5XXXX0 | R/W    |                    |     |
| 0x39     | GAIN1     | [23:0] |            |          |          | GAIN1[23:0]   |            |          | 0x5XXXX0 | R/W    |                    |     |
| 0x3A     | GAIN2     | [23:0] |            |          |          | GAIN2[23:0]   |            |          | 0x5XXXX0 | R/W    |                    |     |
| 0x3B     | GAIN3     | [23:0] |            |          |          | GAIN3[23:0]   |            |          | 0x5XXXX0 | R/W    |                    |     |
| 0x3C     | GAIN4     | [23:0] |            |          |          | GAIN4[23:0]   |            |          | 0x5XXXX0 | R/W    |                    |     |
| 0x3D     | GAIN5     | [23:0] |            |          |          | GAIN5[23:0]   |            |          | 0x5XXXX0 | R/W    |                    |     |
| 0x3E     | GAIN6     | [23:0] |            |          |          | GAIN6[23:0]   |            |          | 0x5XXXX0 | R/W    |                    |     |
| 0x3F     | GAIN7     | [23:0] |            |          |          | GAIN7[23:0]   |            |          | 0x5XXXX0 | R/W    |                    |     |

<sup>1</sup> X means don't care.



## REGISTER DETAILS

### COMMUNICATIONS REGISTER

Address: 0x00, Reset: 0x00, Name: COMMS

All access to the on-chip registers must start with a write to the communications register. This write determines which register is accessed next and whether that operation is a write or a read.

Table 25. Bit Descriptions for COMMS

| Bits  | Bit Name         | Settings                         | Description  | Reset | Access |
|-------|------------------|----------------------------------|--|-------|--------|
| 7     | $\overline{WEN}$ |                                  | This bit must be low to begin communications with the ADC.   | 0x0   | W      |
| 6     | $\overline{R/W}$ | 0                                | Write command.   | 0x0   | W      |
|       |                  | 1                                | Read command.  |       |        |
| [5:0] | RA               |                                  | The register address bits determine the register to be read from or written to as part of the current communication. | 0x00  | W      |
|       | 000000           | Status register.                 |  |       |        |
|       | 000001           | ADC mode register.               |  |       |        |
|       | 000010           | Interface mode register.         |  |       |        |
|       | 000011           | Register checksum register.      |  |       |        |
|       | 000100           | Data register.                   |  |       |        |
|       | 000110           | GPIO configuration register.     |  |       |        |
|       | 000111           | ID register.                     |  |       |        |
|       | 010000           | Channel 0 register.              |  |       |        |
|       | 010001           | Channel 1 register.              |  |       |        |
|       | 010010           | Channel 2 register.              |  |       |        |
|       | 010011           | Channel 3 register.              |  |       |        |
|       | 010100           | Channel 4 register.              |  |       |        |
|       | 010101           | Channel 5 register.              |  |       |        |
|       | 010110           | Channel 6 register.              |  |       |        |
|       | 010111           | Channel 7 register.              |  |       |        |
|       | 011000           | Channel 8 register.              |  |       |        |
|       | 011001           | Channel 9 register.              |  |       |        |
|       | 011010           | Channel 10 register.             |  |       |        |
|       | 011011           | Channel 11 register.             |  |       |        |
|       | 011100           | Channel 12 register.             |  |       |        |
|       | 011101           | Channel 13 register.             |  |       |        |
|       | 011110           | Channel 14 register.             |  |       |        |
|       | 011111           | Channel 15 register.             |  |       |        |
|       | 100000           | Setup Configuration 0 register.  |  |       |        |
|       | 100001           | Setup Configuration 1 register.  |  |       |        |
|       | 100010           | Setup Configuration 2 register.  |  |       |        |
|       | 100011           | Setup Configuration 3 register.  |  |       |        |
|       | 100100           | Setup Configuration 4 register.  |  |       |        |
|       | 100101           | Setup Configuration 5 register.  |  |       |        |
|       | 100110           | Setup Configuration 6 register.  |  |       |        |
|       | 100111           | Setup Configuration 7 register.  |  |       |        |
|       | 101000           | Filter Configuration 0 register. |  |       |        |
|       | 101001           | Filter Configuration 1 register. |  |       |        |
|       | 101010           | Filter Configuration 2 register. |  |       |        |
|       | 101011           | Filter Configuration 3 register. |  |       |        |
|       | 101100           | Filter Configuration 4 register. |  |       |        |
|       | 101101           | Filter Configuration 5 register. |  |       |        |
|       | 101110           | Filter Configuration 6 register. |  |       |        |
|       | 101111           | Filter Configuration 7 register. |  |       |        |

| Bits | Bit Name | Settings | Description        | Reset | Access |
|------|----------|----------|--------------------|-------|--------|
|      |          | 110000   | Offset 0 register. |       |        |
|      |          | 110001   | Offset 1 register. |       |        |
|      |          | 110010   | Offset 2 register. |       |        |
|      |          | 110011   | Offset 3 register. |       |        |
|      |          | 110100   | Offset 4 register. |       |        |
|      |          | 110101   | Offset 5 register. |       |        |
|      |          | 110110   | Offset 6 register. |       |        |
|      |          | 110111   | Offset 7 register. |       |        |
|      |          | 111000   | Gain 0 register.   |       |        |
|      |          | 111001   | Gain 1 register.   |       |        |
|      |          | 111010   | Gain 2 register.   |       |        |
|      |          | 111011   | Gain 3 register.   |       |        |
|      |          | 111100   | Gain 4 register.   |       |        |
|      |          | 111101   | Gain 5 register.   |       |        |
|      |          | 111110   | Gain 6 register.   |       |        |
|      |          | 111111   | Gain 7 register.   |       |        |

## STATUS REGISTER

Address: 0x00, Reset: 0x80, Name: Status

The status register is an 8-bit register that contains ADC and serial interface status information. The register can optionally be appended to the data register by setting the DATA\_STAT bit in the interface mode register.

Table 26. Bit Descriptions for Status

| Bits | Bit Name  | Settings | Description  | Reset | Access |
|------|-----------|----------|--|-------|--------|
| 7    | RDY       | 0<br>1   | The status of RDY is output to the DOUT/RDY pin when CS is low and a register is not being read. This bit goes low when the ADC writes a new result to the data register. In ADC calibration modes, this bit goes low when the ADC writes the calibration result. RDY is brought high automatically by a read of the data register.<br>0 New data result available.<br>1 Awaiting new data result. | 0x1   | R      |
| 6    | ADC_ERROR | 0<br>1   | By default, this bit indicates if an ADC overrange or underrange occurred. The ADC result is clamped to 0xFFFFF for overrange errors and 0x000000 for underrange errors. This bit is updated when the ADC result is written and is cleared at the next update after removing the overrange or underrange condition.<br>0 No error.<br>1 Error.   | 0x0   | R      |
| 5    | CRC_ERROR | 0<br>1   | This bit indicates if a CRC error occurred during a register write. For register reads, the host microcontroller determines if a CRC error occurred. This bit is cleared by a read of this register.<br>0 No error.<br>1 CRC error.  | 0x0   | R      |
| 4    | REG_ERROR | 0<br>1   | This bit indicates if the content of one of the internal registers changes from the value calculated when the register integrity check is activated. The check is activated by setting the REG_CHECK bit in the interface mode register. This bit is cleared by clearing the REG_CHECK bit.<br>0 No error.<br>1 Error.   | 0x0   | R      |

| Bits  | Bit Name | Settings | Description  | Reset | Access |
|-------|----------|----------|--|-------|--------|
| [3:0] | Channel  |          | These bits indicate which channel was active for the ADC conversion whose result is currently in the data register, which may be different from the channel currently being converted. The mapping is a direct map from the channel register; therefore, Channel 0 results in 0x0 and Channel 15 results in 0xF. | 0x0   | R      |
|       |          | 0000     | Channel 0.   |       |        |
|       |          | 0001     | Channel 1.   |       |        |
|       |          | 0010     | Channel 2.   |       |        |
|       |          | 0011     | Channel 3.   |       |        |
|       |          | 0100     | Channel 4.   |       |        |
|       |          | 0101     | Channel 5.   |       |        |
|       |          | 0110     | Channel 6.   |       |        |
|       |          | 0111     | Channel 7.   |       |        |
|       |          | 1000     | Channel 8.   |       |        |
|       |          | 1001     | Channel 9.   |       |        |
|       |          | 1010     | Channel 10.  |       |        |
|       |          | 1011     | Channel 11.  |       |        |
|       |          | 1100     | Channel 12.  |       |        |
|       |          | 1101     | Channel 13.  |       |        |
|       |          | 1110     | Channel 14.  |       |        |
|       |          | 1111     | Channel 15.  |       |        |

### ADC MODE REGISTER

Address: 0x01, Reset: 0x2000, Name: ADCMODE

The ADC mode register controls the operating mode of the ADC and the master clock selection. A write to the ADC mode register resets the filter and the RDY bits and starts a new conversion or calibration.

Table 27. Bit Descriptions for ADCMODE

| Bits    | Bit Name | Settings   | Description  | Reset | Access |
|---------|----------|--|--|-------|--------|
| 15      | REF_EN   | 0<br>1   | This bit enables the internal reference and outputs a buffered 2.5 V to the REFOUT pin.<br>Disabled.<br>Enabled.   | 0x0   | R/W    |
| 14      | Reserved |  | This bit is reserved. Set this bit to 0.   | 0x0   | R/W    |
| 13      | SING_CYC | 0<br>1   | This bit can be used when only a single channel is active to set the ADC to only output at the settled filter data rate.<br>Disabled.<br>Enabled.  | 0x1   | R/W    |
| [12:11] | Reserved |  | These bits are reserved. Set these bits to 0.  | 0x0   | R      |
| [10:8]  | Delay    | 000<br>001<br>010<br>011<br>100<br>101<br>110<br>111 | These bits allow a programmable delay to be added after a channel switch to allow the settling of the external circuitry before the ADC starts processing its input.<br>0 $\mu$ s.<br>16 $\mu$ s.<br>64 $\mu$ s.<br>160 $\mu$ s.<br>400 $\mu$ s.<br>800 $\mu$ s.<br>3 ms.<br>4 ms. | 0x0   | R/W    |
| 7       | Reserved |  | This bit is reserved. Set this bit to 0.   | 0x0   | R      |

| Bits  | Bit Name | Settings   | Description   | Reset | Access |
|-------|----------|--|---|-------|--------|
| [6:4] | Mode     | 000 Continuous conversion mode.<br>001 Single conversion mode.<br>010 Standby mode.<br>011 Power-down mode.<br>100 Internal offset calibration.<br>101 Internal gain calibration<br>110 System offset calibration.<br>111 System gain calibration. | These bits control the operating mode of the ADC. See the Operating Modes section for more information.         | 0x0   | R/W    |
| [3:2] | CLOCKSEL | 00 Internal oscillator<br>01 Internal oscillator output on the XTAL2/CLKIO pin.<br>10 External clock input on the XTAL2/CLKIO pin.<br>11 External crystal on the XTAL1 pin and the XTAL2/CLKIO pin.  | These bits select the ADC clock source. Selecting the internal oscillator also enables the internal oscillator. | 0x0   | R/W    |
| [1:0] | Reserved |  | These bits are reserved. Set these bits to 0.   | 0x0   | R      |

## INTERFACE MODE REGISTER

Address: 0x02, Reset: 0x0000, Name: IFMODE

The interface mode register configures various serial interface options.

Table 28. Bit Descriptions for IFMODE

| Bits    | Bit Name   | Settings                            | Description  | Reset | Access |
|---------|------------|-------------------------------------|--|-------|--------|
| [15:13] | Reserved   |                                     | These bits are reserved Set these bits to 0.   | 0x0   | R      |
| 12      | ALT_SYNC   | 0 Disabled.<br>1 Enabled.           | This bit enables a different behavior of the SYNC pin to allow the use of SYNC as a control for conversions when cycling channels.   | 0x0   | R/W    |
| 11      | IOSTRENGTH | 0 Disabled (default).<br>1 Enabled. | This bit controls the drive strength of the DOUT/RDY pin. Set this bit when reading from the SPI at high speed with a low IOVDD supply and moderate capacitance.   | 0x0   | R/W    |
| [10:9]  | Reserved   |                                     | These bits are reserved. Set these bits to 0.  | 0x0   | R      |
| 8       | DOUT_RESET | 0 Disabled.<br>1 Enabled.           | See the DOUT_RESET section.  | 0x0   | R/W    |
| 7       | CONTREAD   | 0 Disabled.<br>1 Enabled.           | This bit enables the continuous read mode of the ADC data register. The ADC must be configured in continuous conversion mode to use continuous read mode. For more details, see the Operating Modes section.   | 0x0   | R/W    |
| 6       | DATA_STAT  | 0 Disabled.<br>1 Enabled.           | This bit enables the status register to be appended to the data register when read so that channel and status information are transmitted with the data, which is the only way to be sure that the channel bits read from the status register correspond to the data in the data register. | 0x0   | R/W    |

| Bits  | Bit Name  | Settings       | Description  | Reset | Access |
|-------|-----------|----------------|--|-------|--------|
| 5     | REG_CHECK | 0<br>1         | This bit enables a register integrity checker, which can be used to monitor any change in the value of the user registers. To use this feature, configure all other registers as desired with this bit cleared. Then, write to this register to set the REG_CHECK bit to 1. If the contents of any of the registers change, the REG_ERROR bit is set in the status register. To clear the error, set the REG_CHECK bit to 0. Neither the interface mode register nor the ADC data or status registers are included in the registers that are checked. If a register must have a new value written, this bit must first be cleared. Otherwise, an error is flagged when the new register contents are written.<br>Disabled.<br>Enabled. | 0x0   | R/W    |
| 4     | Reserved  |                | This bit is reserved. Set this bit to 0.   | 0x0   | R      |
| [3:2] | CRC_EN    | 00<br>01<br>10 | These bits enable CRC protection of register reads and writes. CRC increases the number of bytes in a SPI transfer by one.<br>Disabled.<br>XOR checksum enabled for register read transactions. Note that register writes still use CRC with these bits set.<br>CRC checksum enabled for read and write transactions.  | 0x00  | R/W    |
| 1     | Reserved  |                | This bit is reserved. Set this bit to 0.   | 0x0   | R      |
| 0     | WL16      | 0<br>1         | This bit changes the ADC data register to 16 bits. The ADC is not reset by a write to the interface mode register. Therefore, the ADC result is not rounded to the correct word length immediately after writing to these bits. The first new ADC result is correct.<br>24-bit data.<br>16-bit data.   | 0x0   | R/W    |

## REGISTER CHECK

Address: 0x03, Reset: 0x000000, Name: REGCHECK

The register check register is a 24-bit checksum calculated by exclusively OR'ing the contents of the user registers. The REG\_CHECK bit in the interface mode register must be set for this checksum to operate. Otherwise, the register reads 0.

Table 29. Bit Descriptions for REGCHECK

| Bits   | Bit Name       | Settings | Description  | Reset    | Access |
|--------|----------------|----------|--|----------|--------|
| [23:0] | REGISTER_CHECK |          | This register contains the 24-bit checksum of user registers when the REG_CHECK bit is set in the interface mode register. | 0x000000 | R      |

## DATA REGISTER

Address: 0x04, Reset: 0x000000, Name: Data

The data register contains the ADC conversion result. The encoding is offset binary, or it can be changed to unipolar by the BI\_UNIPOLARx bits in the setup configuration registers. Reading the data register brings the  $\overline{RDY}$  bit and the  $\overline{RDY}$  output high if it is low. The ADC result can be read multiple times. However, because the  $\overline{RDY}$  output is brought high, it is not possible to determine if another ADC result is imminent. After the command to read the ADC register is received, the ADC does not write a new result into the data register.

Table 30. Bit Descriptions for Data

| Bits   | Bit Name | Settings | Description  | Reset    | Access |
|--------|----------|----------|--|----------|--------|
| [23:0] | Data     |          | This register contains the ADC conversion result. If DATA_STAT is set in the interface mode register, the status register is appended to this register when read, making this a 32-bit register. | 0x000000 | R      |

**GPIO CONFIGURATION REGISTER**

Address: 0x06, Reset: 0x0800, Name: GPIOCON

The GPIO configuration register controls the general-purpose input and output pins of the ADC.

**Table 31. Bit Descriptions for GPIOCON**

| Bits    | Bit Name | Settings             | Description  | Reset | Access |
|---------|----------|----------------------|--|-------|--------|
| [15:14] | Reserved |                      | Reserved.  | 0x0   | R      |
| 13      | OP_EN2_3 | 0<br>1               | GPO2/GPO3 Output Enable. This bit enables the GPO2 and GPO3 pins. The outputs are referenced between AVDD and AVSS.<br>0 Disabled.<br>1 Enabled.   | 0x0   | R/W    |
| 12      | MUX_IO   |                      | This bit allows the ADC to control an external multiplexer, using GPIO0/GPIO1/GPO2/GPO3 in sync with the internal channel sequencing. The analog input pins used for a channel can still be selected on a per channel basis. Therefore, it is possible to have a 16-channel multiplexer in front of each analog input pair (VIN0/VIN1 to VIN10/VINCOM and ADCIN11/ADCIN12 to ADCIN13/ADCIN14), giving a total of 128 differential channels. However, only 16 channels at a time can be automatically sequenced. Following the sequence of 16 channels, the user changes the analog input to the next pair of input channels, and it sequences through the next 16 channels. There is a delay function that allows extra time for the analog input to settle, in conjunction with any switching of an external multiplexer (see the delay bits in the ADC Mode Register section).   | 0x0   | R      |
| 11      | SYNC_EN  | 0<br>1               | SYNC Input Enable. This bit enables the SYNC pin as a sync input. When set low, the SYNC pin holds the ADC and filter in reset until SYNC goes high. An alternative operation of the SYNC pin is available when the ALT_SYNC bit in the interface mode register is set. This mode works only when multiple channels are enabled. In such cases, a low on the SYNC pin does not immediately reset the filter and modulator. Instead, if the SYNC pin is low when the channel is due to be switched, the modulator and filter are prevented from starting a new conversion. Bringing SYNC high begins the next conversion. This alternative sync mode allows SYNC to be used while cycling through channels.<br>0 Disabled.<br>1 Enabled.  | 0x1   | R/W    |
| [10:9]  | ERR_EN   | 00<br>01<br>10<br>11 | ERROR Pin Mode. These bits enable the ERROR pin as an error input and output.<br>00 Disabled.<br>01 Enables error input (active low). ERROR is an error input. The (inverted) readback state is OR'ed with other error sources and is available in the ADC_ERROR bit in the status register. The ERROR pin state can also be read from the ERR_DAT bit in this register.<br>10 Enables open-drain error output (active low). ERROR is an open-drain error output. The status register error bits are OR'ed, inverted, and mapped to the ERROR pin. ERROR pins of multiple devices can be wired together to a common pull-up resistor so that an error on any device can be observed.<br>11 General-purpose output (active low). ERROR is a general-purpose output. The status of the pin is controlled by the ERR_DAT bit in this register. This output is referenced between IOVDD and DGND, as opposed to the AVDD and AVSS levels used by the GPIOx pins. The output has an active pull-up resistor in this case. | 0x0   | R/W    |
| 8       | ERR_DAT  | 0<br>1               | ERROR Pin Data. This bit determines the logic level at the ERROR pin if the pin is enabled as a general-purpose output. This bit reflects the readback status of the pin if the pin is enabled as an input.<br>0 Logic 0.<br>1 Logic 1.  | 0x0   | R/W    |
| 7       | GP_DATA3 | 0<br>1               | GPO1 Data. This bit is the write data for GPO1.<br>0 GPO1 = 0.<br>1 GPO1 = 1.  | 0x0   | R/W    |
| 6       | GP_DATA2 | 0<br>1               | GPO0 Data. This bit is the write data for GPO0.<br>0 GPO0 = 0.<br>1 GPO0 = 1.  | 0x0   | R/W    |

| Bits | Bit Name | Settings | Description   | Reset | Access |
|------|----------|----------|---|-------|--------|
| 5    | IP_EN1   | 0<br>1   | This bit runs GPIO1 into an input. Input must be equal to AVDD or AVSS.<br>Disabled.<br>Enabled.          | 0x0   | R/W    |
| 4    | IP_EN0   | 0<br>1   | This bit runs GPIO0 into an input. Input must be equal to AVDD or AVSS.<br>Disabled.<br>Enabled.          | 0x0   | R/W    |
| 3    | OP_EN1   | 0<br>1   | This bit runs GPIO1 into an output. Outputs are referenced between AVDD or AVSS.<br>Disabled.<br>Enabled. | 0x0   | R/W    |
| 2    | OP_EN0   | 0<br>1   | This bit runs GPIO0 into an output. Outputs are referenced between AVDD or AVSS.<br>Disabled.<br>Enabled. | 0x0   | R/W    |
| 1    | GP_DATA1 |          | This bit is the readback or write data for GPIO1.   | 0x0   | R/W    |
| 0    | GP_DATA0 |          | This bit is the readback or write data for GPIO0.   | 0x0   | R/W    |

## ID REGISTER

Address: 0x07, Reset: 0x34DX, Name: ID

The ID register returns a 16-bit ID. For the AD4116, this value is 0x34Dx.

Table 32. Bit Descriptions for ID

| Bits   | Bit Name | Settings | Description   | Reset  | Access |
|--------|----------|----------|---|--------|--------|
| [15:0] | ID       |          | Product ID. The ID register returns a 16-bit ID code that is specific to the ADC. | 0x34DX | R      |

## CHANNEL REGISTER 0 TO CHANNEL REGISTER 15

Address: 0x10 to Address 0x1F, Reset: 0x8001, Name: CH0 to CH15

The channel registers are 16-bit registers that select the currently active channels, the selected inputs for each channel, and the setup to be used to configure the ADC for that channel. The layout for CH0 to CH15 is identical except that the default CH\_ENx bit for CH1 to CH15 is 0x0.

Table 33. Bit Descriptions for CH0 to CH15

| Bits    | Bit Name   | Settings   | Description   | Reset | Access |
|---------|------------|--|---|-------|--------|
| 15      | CH_ENx     | 0<br>1   | This bit enables Channel 0. If more than one channel is enabled, the ADC automatically sequences between them.<br>Disabled.<br>Enabled.   | 0x1   | R/W    |
| [14:12] | SETUP_SELx | 000<br>001<br>010<br>011<br>100<br>101<br>110<br>111 | These bits identify which of the eight setups is used to configure the ADC for this channel. A setup comprises a set of four registers: a setup configuration register, a filter configuration register, an offset register, and a gain register. All channels can use the same setup, in which case, the same 3-bit value must be written to these bits on all active channels, or up to eight channels can be configured differently.<br>Setup 0.<br>Setup 1.<br>Setup 2.<br>Setup 3.<br>Setup 4.<br>Setup 5.<br>Setup 6.<br>Setup 7. | 0x0   | R/W    |
| [11:10] | Reserved   |  | Reserved.   | 0x0   | R      |

| Bits  | Bit Name | Settings  | Description   | Reset | Access |
|-------|----------|-----------|---|-------|--------|
| [9:0] | INPUTx   |           | These bits select which input pair is connected to the input of the ADC for this channel. | 0x1   | R/W    |
|       |          | 000000001 | VIN0 and VIN1.  |       |        |
|       |          | 000001000 | VIN0 and VINCOM.  |       |        |
|       |          | 000010000 | VIN1 and VIN0.  |       |        |
|       |          | 000011000 | VIN1 and VINCOM.  |       |        |
|       |          | 000100011 | VIN2 and VIN3.  |       |        |
|       |          | 000101000 | VIN2 and VINCOM.  |       |        |
|       |          | 000110001 | VIN3 and VIN2.  |       |        |
|       |          | 000111000 | VIN3 and VINCOM.  |       |        |
|       |          | 001000010 | VIN4 and VIN5.  |       |        |
|       |          | 001001000 | VIN4 and VINCOM.  |       |        |
|       |          | 001010010 | VIN5 and VIN4.  |       |        |
|       |          | 001011000 | VIN5 and VINCOM.  |       |        |
|       |          | 001100011 | VIN6 and VIN7.  |       |        |
|       |          | 001101000 | VIN6 and VINCOM.  |       |        |
|       |          | 001110010 | VIN7 and VIN6.  |       |        |
|       |          | 001111000 | VIN7 and VINCOM.  |       |        |
|       |          | 010000100 | VIN8 and VIN9.  |       |        |
|       |          | 010001000 | VIN8 and VINCOM.  |       |        |
|       |          | 010010100 | VIN9 and VIN8.  |       |        |
|       |          | 010011000 | VIN9 and VINCOM.  |       |        |
|       |          | 010101000 | VIN10, VINCOM (single-ended or differential pair)   |       |        |
|       |          | 010110100 | ADCIN11, ADCIN12.   |       |        |
|       |          | 011000101 | ADCIN12, ADCIN11.   |       |        |
|       |          | 011010110 | ADCIN13, ADCIN14.   |       |        |
|       |          | 011100101 | ADCIN14, ADCIN13.   |       |        |
|       |          | 010110111 | ADCIN11, ADCIN15. (pseudo differential or differential pair)                              |       |        |
|       |          | 011000111 | ADCIN12, ADCIN15. (pseudo differential or differential pair)                              |       |        |
|       |          | 011010111 | ADCIN13, ADCIN15. (pseudo differential or differential pair)                              |       |        |
|       |          | 011100111 | ADCIN14, ADCIN15. (pseudo differential or differential pair)                              |       |        |
|       |          | 100011001 | Temperature sensor.   |       |        |
|       |          | 101011010 | Reference.  |       |        |

## SETUP CONFIGURATION REGISTER 0 TO SETUP CONFIGURATION REGISTER 7

Address: 0x20 to 0x27, Reset: 0x1000 Name: SETUPCON0 to SETUPCON7

The setup configuration registers are 16-bit registers that configure the reference selection, input buffers, and output coding of the ADC. The layout for SETUPCON0 to SETUPCON7 is identical.

Table 34. Bit Descriptions for SETUPCON0 to SETUPCON7

| Bits    | Bit Name     | Settings | Description  | Reset | Access |
|---------|--------------|----------|--|-------|--------|
| [15:13] | Reserved     |          | These bits are reserved. Set these bits to 0.  | 0x0   | R      |
| 12      | BI_UNIPOLARx |          | Bipolar and Unipolar Output. This bit sets the output coding of the ADC for Setup 0. | 0x1   | R/W    |
|         |              | 0        | Unipolar coded output.   |       |        |
|         |              | 1        | Bipolar coded output.  |       |        |
| 11      | REFBUFx+     |          | REF+ Buffer. This bit enables or disables the REF+ input buffer.                     | 0x0   | R/W    |
|         |              | 0        | Disabled.  |       |        |
|         |              | 1        | Enabled.   |       |        |
| 10      | REFBUFx-     |          | REF- Buffer. This bit enables or disables the REF- input buffer.                     | 0x0   | R/W    |
|         |              | 0        | Disabled.  |       |        |
|         |              | 1        | Enabled.   |       |        |



| Bits  | Bit Name | Settings             | Description   | Reset | Access |
|-------|----------|----------------------|---|-------|--------|
| [9:8] | INBUFx   | 00<br>01<br>10<br>11 | Input Buffer. This bit enables or disables input buffers.<br>Disabled.<br>Reserved.<br>Reserved.<br>Enabled.  | 0x0   | R/W    |
| [7:6] | Reserved |                      | This bit is reserved. Set this bit to 0.  | 0x0   | R      |
| [5:4] | REF_SELx | 00<br>10<br>11       | These bits allow the user to select the reference source for ADC conversion on Setup 0.<br>External reference – REF±.<br>Internal 2.5 V reference must be enabled via ADCMODE (see Table 27).<br>AVDD – AVSS. | 0x0   | R/W    |
| [3:0] | Reserved |                      | These bits are reserved. Set these bits to 0.   | 0x0   | R      |

### FILTER CONFIGURATION REGISTER 0 TO FILTER CONFIGURATION REGISTER 7

Address: 0x28 to 0x2F, Reset: 0x0500, Name: FILTCON0 to FILTCON7

The filter configuration registers are 16-bit registers that configure the ADC data rate and filter options. Writing to any of these registers resets any active ADC conversion and restarts converting at the first channel in the sequence. The layout for FILTCON0 to FILTCON7 is identical.

Table 35. Bit Descriptions for FILTCON0 to FILTCON7

| Bits    | Bit Name   | Settings   | Description  | Reset | Access |
|---------|------------|--|--|-------|--------|
| 15      | SINC3_MAPx |  | If this bit is set, the mapping of the filter register changes to directly program the decimation rate of the sinc3 filter for Setup 0. All other options are eliminated. This bit allows fine tuning of the output data rate and filter notch for rejection of specific frequencies. The data rate when on a single channel equals $f_{MOD}/(32 \times FILTCON0[14:0])$ .   | 0x0   | R/W    |
| [14:12] | Reserved   |  | These bits are reserved. Set these bits to 0.  | 0x0   | R      |
| 11      | ENHFILTENx | 0<br>1   | This bit enables various post filters for enhanced 50 Hz/60 Hz rejection for Setup 0. The ORDER0 bits must be set to 00 to select the sinc5 + sinc1 filter for this function to work.<br>Disabled.<br>Enabled.   | 0x0   | R/W    |
| [10:8]  | ENHFILTx   | 010<br>011<br>101<br>110   | These bits select between various post filters for enhanced 50 Hz/60 Hz rejection for Setup 0.<br>27 SPS, 47 dB rejection, and 36.7 ms settling.<br>25 SPS, 62 dB rejection, and 40 ms settling.<br>20 SPS, 86 dB rejection, and 50 ms settling.<br>16.67 SPS, 92 dB rejection, and 60 ms settling.  | 0x5   | R/W    |
| 7       | Reserved   |  | This bit is reserved. Set this bit to 0.   | 0x0   | R      |
| [6:5]   | ORDERx     | 00<br>11   | These bits control the order of the digital filter that processes the modulator data for Setup 0.<br>Sinc5 + sinc1 (default).<br>Sinc3.  | 0x0   | R/W    |
| [4:0]   | ODRx       | 00000<br>00001<br>00010<br>00011<br>00100<br>00101<br>00110<br>00111<br>01000<br>01001<br>01010<br>01011 | These bits control the output data rate of the ADC and, therefore, the settling time and noise for Setup x. Rates shown are for single channel enabled sinc5 + sinc 1 filter. See Table 7 for multiple channels enabled.<br>62500 SPS.<br>62500 SPS.<br>62500 SPS.<br>62500 SPS.<br>31250 SPS.<br>31250 SPS.<br>15625 SPS.<br>10416.7 SPS.<br>5194.8 SPS (5208.3 SPS for sinc3).<br>2496.9 SPS (2500 SPS for sinc3).<br>1007.6 SPS (1008.1 SPS for sinc3).<br>499.9 SPS (500 SPS for sinc3). | 0x0   | R/W    |

| Bits | Bit Name | Settings | Description                       | Reset | Access |
|------|----------|----------|-----------------------------------|-------|--------|
|      |          | 01100    | 390.6 SPS (400.64 SPS for sinc3). |       |        |
|      |          | 01101    | 200.3 SPS (200.32 SPS for sinc3). |       |        |
|      |          | 01110    | 100.0 SPS.                        |       |        |
|      |          | 01111    | 59.75 SPS (59.98 SPS for sinc3).  |       |        |
|      |          | 10000    | 49.84 SPS (50 SPS for sinc3).     |       |        |
|      |          | 10001    | 20.00 SPS.                        |       |        |
|      |          | 10010    | 16.65 SPS (16.67 SPS for sinc3).  |       |        |
|      |          | 10011    | 10.00 SPS.                        |       |        |
|      |          | 10100    | 5.00 SPS.                         |       |        |
|      |          | 10101    | 2.50 SPS.                         |       |        |
|      |          | 10110    | 1.25 SPS.                         |       |        |

### OFFSET REGISTER 0 TO OFFSET REGISTER 7

Address: 0x30 to 0x37, Reset: 0x800000, Name: OFFSET0 to OFFSET7

The offset (zero-scale) registers are 16-bit registers that can be used to compensate for any offset error in the ADC or in the system. The layout for OFFSET0 to OFFSET7 is identical.

Table 36. Bit Descriptions for OFFSET0 to OFFSET7

| Bits   | Bit Name | Settings | Description                                 | Reset    | Access |
|--------|----------|----------|---|----------|--------|
| [23:0] | OFFSETx  |          | Offset calibration coefficient for Setup 0. | 0x800000 | R/W    |

### GAIN REGISTER 0 TO GAIN REGISTER 7

Address: 0x38 to 0x3F, Reset: 0x5XXXX0, Name: GAIN0 to GAIN7

The gain (full-scale) registers are 16-bit registers that can be used to compensate for any gain error in the ADC or in the system. The layout for GAIN0 to GAIN7 is identical.

Table 37. Bit Descriptions for GAIN0 to GAIN7

| Bits   | Bit Name | Settings | Description                               | Reset <sup>1</sup> | Access |
|--------|----------|----------|---|--------------------|--------|
| [23:0] | GAINx    |          | Gain calibration coefficient for Setup 0. | 0x5XXXX0           | R/W    |

<sup>1</sup> X means don't care.

# OUTLINE DIMENSIONS

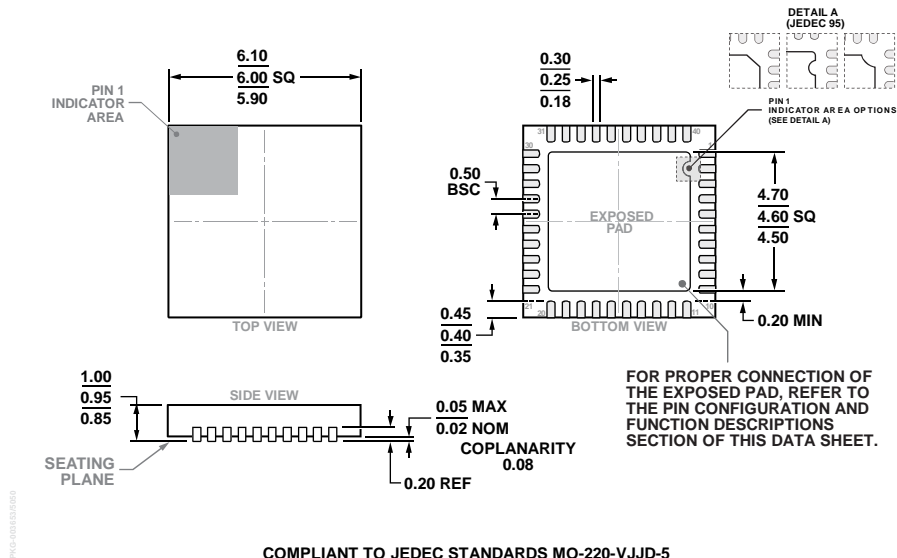

COMPLIANT TO JEDEC STANDARDS MO-220-VJJD-5

Figure 62. 40-Lead Lead Frame Chip Scale Package [LFCS]  
 6 mm × 6 mm Body and 0.95 mm Package Height  
 (CP-40-15)  
 Dimensions shown in millimeters

## ORDERING GUIDE

| Model <sup>1</sup> | Temperature Range | Package Description                          | Package Option |
|--------------------|-------------------|--|----------------|
| AD4116BCPZ         | -40°C to +105°C   | 40-Lead Lead Frame Chip Scale Package [LFCS] | CP-40-15       |
| AD4116BCPZ-RL7     | -40°C to +105°C   | 40-Lead Lead Frame Chip Scale Package [LFCS] | CP-40-15       |
| EVAL-AD4116ASDZ    |                   | Evaluation Board                             |                |
| EVAL-SDP-CB1Z      |                   | Evaluation Controller Board                  |                |

<sup>1</sup> Z = RoHS Compliant Part.