

16x16 Video Crosspoint

The ISL59530 is a 300MHz 16x16 Video Crosspoint Switch. Each input has an integrated DC-restore clamp and an input buffer. Each output has a fast On-Screen Display (OSD) switch (for inserting graphics or other video) and an output buffer. The switch is non-blocking, so any combination of inputs to outputs can be chosen, including one channel driving multiple outputs. The Broadcast Mode directs one input to all 16 outputs. The output buffers can be individually controlled through the SPI interface, the gain can be programmed to x1 or x2, and each output can be placed into a high impedance mode.

The ISL59530 offers a typical -3dB signal bandwidth of 300MHz. Differential gain of 0.025% and differential phase of 0.05°, along with 0.1dB flatness out to 50MHz, make the ISL59530 suitable for many video applications.

The switch matrix configuration and output buffer gain are programmed through an SPI/QSPI™-compatible three-wire serial interface. The ISL59530 interface is designed to facilitate both fast updates and initialization. On power-up, all outputs are high impedance to avoid output conflicts.

The ISL59530 is available in both a 356 ball PBGA package and 72 Ld QFN package and is specified over an extended -40°C to +85°C temperature range.

The single-supply ISL59530 can accommodate input signals from 0V to 3.5V and output voltages from 0V to 3.8V. Each input includes a clamp circuit that restores the input level to an externally applied reference in AC-coupled applications.

The ISL59531 is a fully differential input version of this device.

Features

- 16x16 non-blocking switch with buffered inputs and outputs
- 300MHz typical bandwidth
- 0.025%/0.05° dG/dP
- Output gain switchable x1 or x2 for each channel
- Individual outputs can be put in a high impedance state
- -90dB Isolation at 6MHz
- SPI digital interface
- Single +5V supply operation
- Pb-free (RoHS compliant)

Applications

- Security camera switching
- RGB routing
- HDTV routing

Ordering Information

PART NUMBER	PART MARKING	PACKAGE (Pb-Free)	PKG. DWG. #
ISL59530IKZ (Note 1)	ISL59530IKZ	356 Ld PBGA	V356.27x27B
ISL59530IRZ (Note 2)	ISL59530IRZ	72 Ld QFN	L72.10x10C

NOTES:

1. These Intersil Pb-free WLCSP and BGA packaged products employ special Pb-free material sets; molding compounds/die attach materials and SnAgCu - e1 solder ball terminals, which are RoHS compliant and compatible with both SnPb and Pb-free soldering operations. Intersil Pb-free WLCSP and BGA packaged products are MSL classified at Pb-free peak reflow temperatures that meet or exceed the Pb-free requirements of IPC/JEDEC J STD-020.
2. These Intersil Pb-free plastic packaged products employ special Pb-free material sets, molding compounds/die attach materials, and 100% matte tin plate plus anneal (e3 termination finish, which is RoHS compliant and compatible with both SnPb and Pb-free soldering operations). Intersil Pb-free products are MSL classified at Pb-free peak reflow temperatures that meet or exceed the Pb-free requirements of IPC/JEDEC J STD-020.

Block Diagram

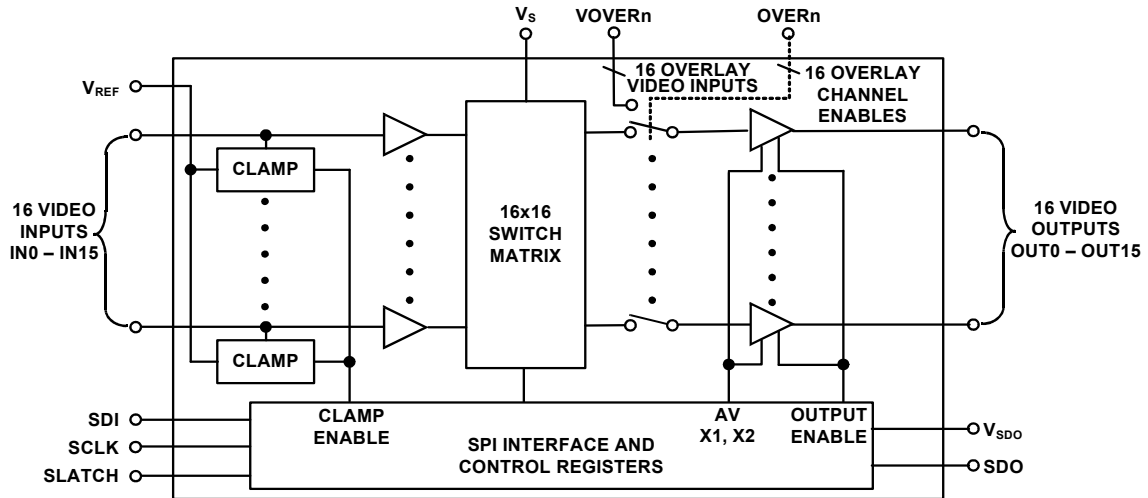

ISL59530

Pinouts

ISL59530
(356 LD PBGA)
TOP VIEW

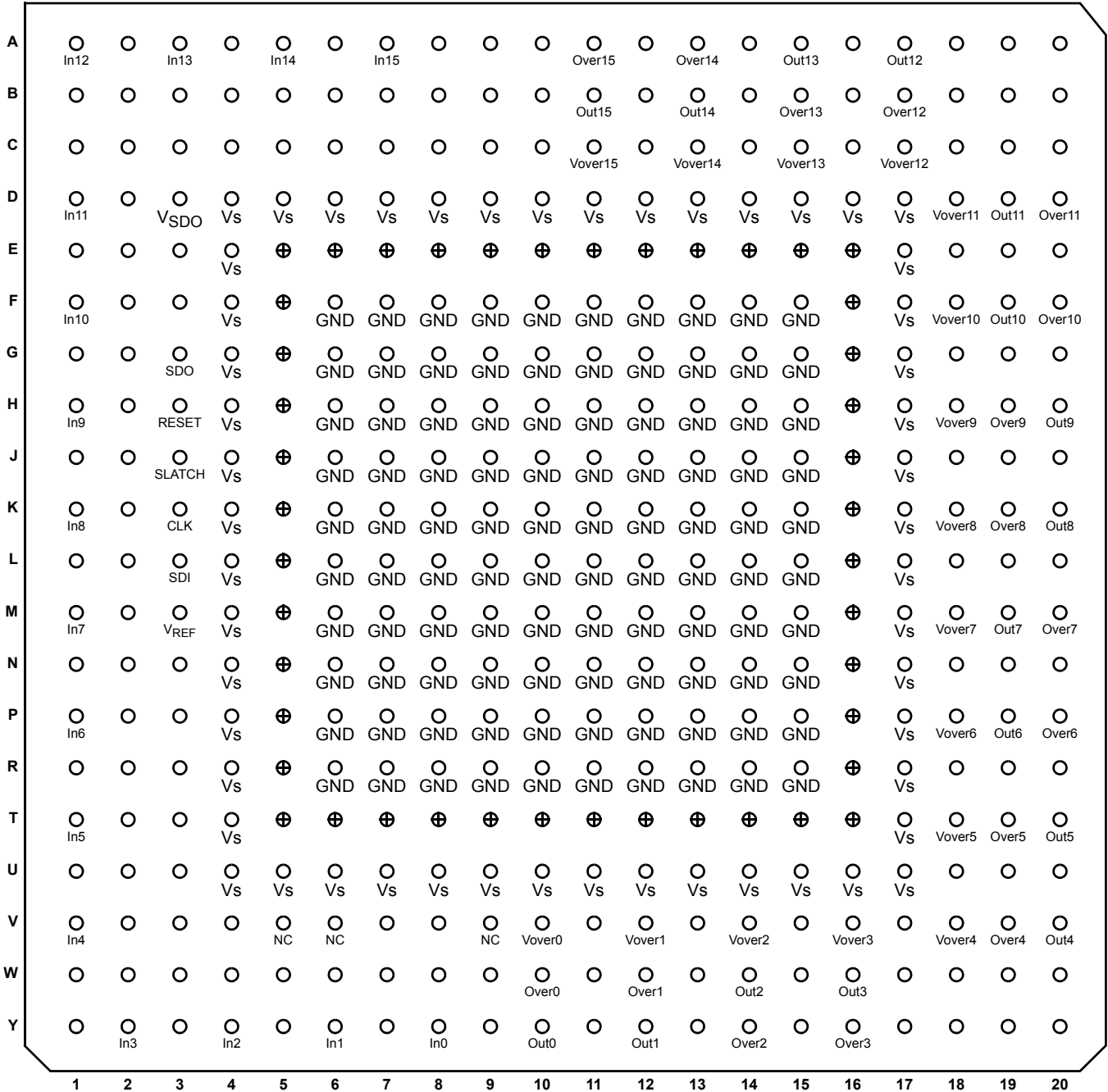

⊕ = NO BALLS

BALLS LABELLED "NC" SHOULD BE LEFT UNCONNECTED - DO NOT TIE THEM TO GROUND!
BALLS WITH NO LABELS MAY BE TIED TO GROUND TO SLIGHTLY REDUCE THERMAL IMPEDANCE.

ISL59530

Pinouts (Continued)

ISL59530
(72 LD QFN)
TOP VIEW

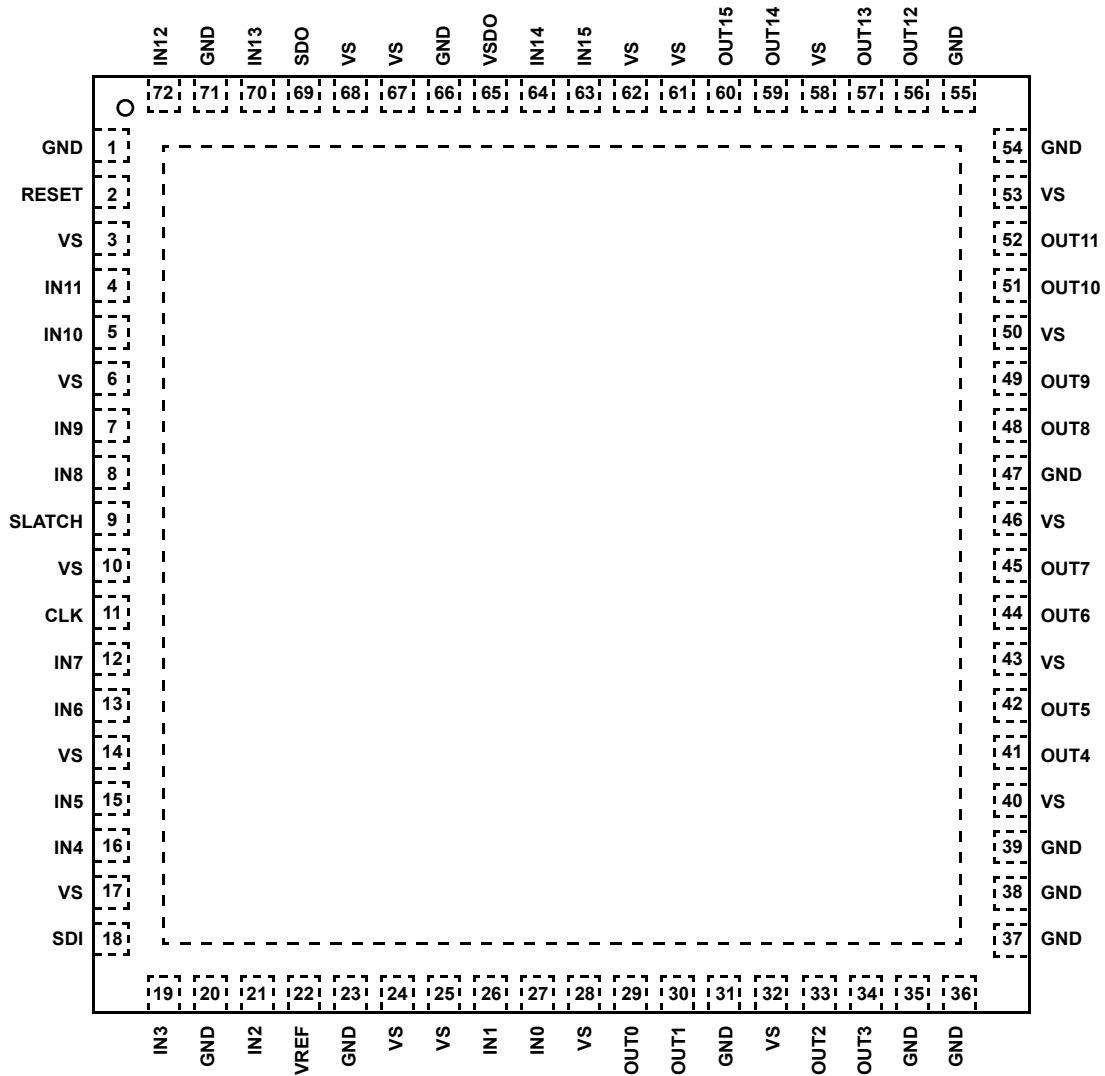

Absolute Maximum Ratings ($T_A = +25^{\circ}\text{C}$)

Supply Voltage between V_S and GND	6.0V
Maximum Continuous Output Current	40mA
Maximum power supply (V_S) slew rate	1V/ μs

Thermal Information

Thermal Resistance	θ_{JA} ($^{\circ}\text{C}/\text{W}$)	θ_{JC} ($^{\circ}\text{C}/\text{W}$)
72 Ld QFN (Note 3)	27	N/A
356 Ld PBGA (Notes 4, 5)	29.7	14.6
Maximum Die Temperature	+125 $^{\circ}\text{C}$	
Storage Temperature	-65 $^{\circ}\text{C}$ to +150 $^{\circ}\text{C}$	
Pb-free reflow profile	see link below	
http://www.intersil.com/pbfree/Pb-FreeReflow.asp		

CAUTION: Do not operate at or near the maximum ratings listed for extended periods of time. Exposure to such conditions may adversely impact product reliability and result in failures not covered by warranty.

NOTES:

- θ_{JA} is measured in free air with the component mounted on a high effective thermal conductivity test board with “direct attach” features. See Tech Brief TB379
- θ_{JA} is measured with the component mounted on a high effective thermal conductivity test board in free air. See Tech Brief TB379 for details.
- For θ_{JC} , the “case temp” location is taken at the package top center.

DC Electrical Specifications $V_S = 5\text{V}$, $R_L = 150\Omega$ unless otherwise noted.

PARAMETER	DESCRIPTION	CONDITION	MIN (Note 6)	TYP	MAX (Note 6)	UNIT
V_S	Power Supply Voltage		4.5		5.5	V
V_{SDO}	Power Supply for SDO output pin	Establishes serial data output high level	1.2		5.5	V
A_V	Gain	$A_V = 1$	0.98	1	1.02	V/V
		$A_V = 2$	1.96	2	2.04	V/V
GM	Gain Matching (to average of all other outputs)	$A_V = 1$	-1.5		+1.5	%
		$A_V = 2$	-1.5		+1.5	%
V_{IN}	Video Input Voltage Range	$A_V = 1$	0		3.5	V
V_{OUT}	Video Output Voltage Range	$A_V = 2$	0.1		3.8	V
I_B	Input Bias Current	Clamp function disabled (DC-coupled inputs)	-10	-5	1	μA
		Clamp function enabled, $V_{IN} = V_{REF} + 0.5\text{V}$	0.5	2	10	μA
I_{REF}	V_{REF} Input Current	Clamp function enabled		-110		μA
V_{OS}	Output Offset Voltage	$A_V = 1$	-20	8	35	mV
		$A_V = 2$	-70	-10	40	mV
I_{OUT}	Output Current	Sourcing, $R_L = 10\Omega$ to GND	60	108		mA
		Sinking, $R_L = 10\Omega$ to 2.5V	24	31		mA
PSRR	Power Supply Rejection Ratio	$A_V = 1$ and $A_V = 2$	50	70		dB
I_S	Supply Current	Enabled, all outputs enabled, no load current	275	320	360	mA
		Enabled, all outputs disabled, no load current	135	165	195	mA
		Disabled	1.2	1.8	2.4	mA

AC Electrical Specifications $V_S = 5\text{V}$, $R_L = 150\Omega$ unless otherwise noted.

PARAMETER	DESCRIPTION	CONDITION	MIN (Note 6)	TYP	MAX (Note 6)	UNIT
BW -3dB	3dB Bandwidth	$V_{OUT} = 200\text{mV}_{P-P}$, $A_V = 2$		300		MHz
BW 0.1dB	0.1dB Bandwidth	$V_{OUT} = 200\text{mV}_{P-P}$, $A_V = 2$		50		MHz
SR	Slew Rate	$V_{OUT} = 2V_{P-P}$, $A_V = 2$	300	520	740	V/ μs
t_s	Settling Time to 0.1%	$V_{OUT} = 2V_{P-P}$, $A_V = 2$		12		ns
Glitch	Switching Glitch, Peak	$A_V = 1$		40		mV
t_{over}	Overlay Delay Time	From OVER rising edge to output transition		6		ns

AC Electrical Specifications $V_S = 5V, R_L = 150\Omega$ unless otherwise noted. (Continued)

PARAMETER	DESCRIPTION	CONDITION	MIN (Note 6)	TYP	MAX (Note 6)	UNIT
dG	Diff Gain	$A_V = 2, R_L = 150\Omega$		0.025		%
dP	Diff Phase	$A_V = 2, R_L = 150\Omega$		0.05		°
XT _{ADJACENT}	Adjacent Channel Crosstalk	6MHz, $A_V = 1$		-90		dB
XT _{HOSTILE}	Hostile Crosstalk	6MHz, $A_V = 1$		-72		dB
V _N	Input Referred Noise Voltage			18		nV/ \sqrt{Hz}

NOTE:

- Compliance to datasheet limits is assured by one or more methods: production test, characterization and/or design.

Pin Descriptions

72 LD QFN	356 LD PBGA	NAME	DESCRIPTION
27	Y8	IN0	Crosspoint Video Input
26	Y6	IN1	Crosspoint Video Input
21	Y4	IN2	Crosspoint Video Input
19	Y2	IN3	Crosspoint Video Input
16	V1	IN4	Crosspoint Video Input
15	T1	IN5	Crosspoint Video Input
13	P1	IN6	Crosspoint Video Input
12	M1	IN7	Crosspoint Video Input
8	K1	IN8	Crosspoint Video Input
7	H1	IN9	Crosspoint Video Input
5	F1	IN10	Crosspoint Video Input
4	D1	IN11	Crosspoint Video Input
72	A1	IN12	Crosspoint Video Input
70	A3	IN13	Crosspoint Video Input
64	A5	IN14	Crosspoint Video Input
63	A7	IN15	Crosspoint Video Input
29	Y10	OUT0	Crosspoint Video Output
30	Y12	OUT1	Crosspoint Video Output
33	W14	OUT2	Crosspoint Video Output
34	W16	OUT3	Crosspoint Video Output
41	V20	OUT4	Crosspoint Video Output
42	T20	OUT5	Crosspoint Video Output
44	P19	OUT6	Crosspoint Video Output
45	M19	OUT7	Crosspoint Video Output
48	K20	OUT8	Crosspoint Video Output
49	H20	OUT9	Crosspoint Video Output
51	F19	OUT10	Crosspoint Video Output
52	D19	OUT11	Crosspoint Video Output
56	A17	OUT12	Crosspoint Video Output

Pin Descriptions (Continued)

72 LD QFN	356 LD PBGA	NAME	DESCRIPTION
57	A15	OUT13	Crosspoint Video Output
59	B13	OUT14	Crosspoint Video Output
60	B11	OUT15	Crosspoint Video Output
-	W10	OVER0	Overlay Logic Control (with pull-down)
-	W12	OVER1	Overlay Logic Control (with pull-down)
-	Y14	OVER2	Overlay Logic Control (with pull-down)
-	Y16	OVER3	Overlay Logic Control (with pull-down)
-	V19	OVER4	Overlay Logic Control (with pull-down)
-	T19	OVER5	Overlay Logic Control (with pull-down)
-	P20	OVER6	Overlay Logic Control (with pull-down)
-	M20	OVER7	Overlay Logic Control (with pull-down)
-	K19	OVER8	Overlay Logic Control (with pull-down)
-	H19	OVER9	Overlay Logic Control (with pull-down)
-	F20	OVER10	Overlay Logic Control (with pull-down)
-	D20	OVER11	Overlay Logic Control (with pull-down)
-	B17	OVER12	Overlay Logic Control (with pull-down)
-	B15	OVER13	Overlay Logic Control (with pull-down)
-	A13	OVER14	Overlay Logic Control (with pull-down)
-	A11	OVER15	Overlay Logic Control (with pull-down)
-	V10	VOVER0	Overlay Video Input
-	V12	VOVER1	Overlay Video Input
-	V14	VOVER2	Overlay Video Input
-	V16	VOVER3	Overlay Video Input
-	V18	VOVER4	Overlay Video Input
-	T18	VOVER5	Overlay Video Input
-	P18	VOVER6	Overlay Video Input
-	M18	VOVER7	Overlay Video Input
-	K18	VOVER8	Overlay Video Input
-	H18	VOVER9	Overlay Video Input
-	F18	VOVER10	Overlay Video Input
-	D18	VOVER11	Overlay Video Input
-	C17	VOVER12	Overlay Video Input
-	C15	VOVER13	Overlay Video Input
-	C13	VOVER14	Overlay Video Input
-	C11	VOVER15	Overlay Video Input

Pin Descriptions (Continued)

72 LD QFN	356 LD PBGA	NAME	DESCRIPTION
22	M3	VREF	DC-restore clamp reference input. In an AC-coupled configuration (DC-restore clamp enabled), the sync tip of composite video inputs will be restored to this level. Set to 0.3V to 0.7V for optimum performance. In an DC-coupled configuration (DC-restore clamp disabled), this pin should be tied to ground. Do not let the VREF pin float! A floating VREF pin drifts high and, if the clamp function is enabled, will cause all of the outputs to simultaneously try to drive ~4V DC into their 150Ω loads.
9	J3	SLATCH	Serial Latch. Serial data is latched into ISL59530 on rising edge of SLATCH.
11	K3	CLK	Serial data clock
18	L3	SDI	Serial data input
69	G3	SDO	Serial data output. Can be tied to SDI of another ISL59530 to enable daisy-chaining of multiple devices.
2	H3	RESET	Reset input. Pull high then low to reset device, but not needed in normal operation. Tie to ground in final application.
65	D3	VSDO	Power supply for SDO pin. Tie to +5V for a 0V to 5V SDO output signal swing.
3, 6, 10, 14, 17, 24, 25, 28, 32, 40, 43, 46, 50, 53, 58, 61, 62, 67, 68	D4, E4, F4, G4, H4, J4, K4, L4, M4, N4, P4, R4, T4, U4, D5, D6, D7, D8, D9, D10, D11, D12, D13, D14, D15, D16, D17, U5, U6, U7, U8, U9, U10, U11, U12, U13, U14, U15, U16, U17, E17, F17, G17, H17, J17, K17, L17, M17, N17, P17, R17, T17	VS	+5V power supply
1, 20, 23, 31, 35, 36, 37, 38, 39, 47, 54, 55, 66, 71	F6-R6, F7-R7, F8-R8, F9-R9, F10-R10, F11-R11, F12-R12, F13-R13, F14-R14, F15-R15	GND	Ground
	V5, V6, V9	NC	No Connect - Do not electrically connect to anything, including ground.

Typical Performance Curves

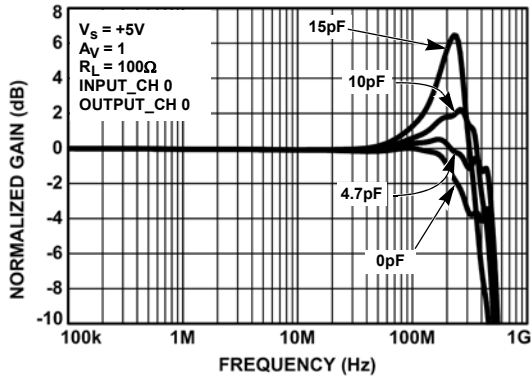

FIGURE 1. FREQUENCY RESPONSE - VARIOUS C_L , $A_V = 1$, MUX MODE

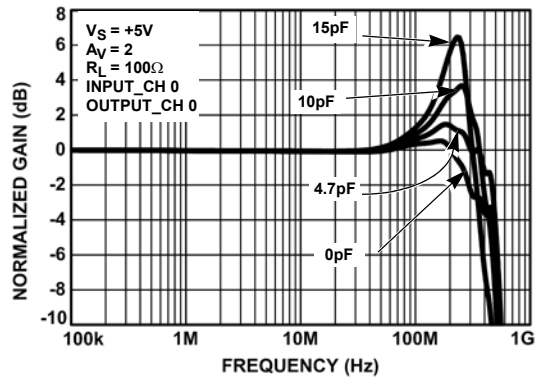

FIGURE 2. FREQUENCY RESPONSE - VARIOUS C_L , $A_V = 2$, MUX MODE

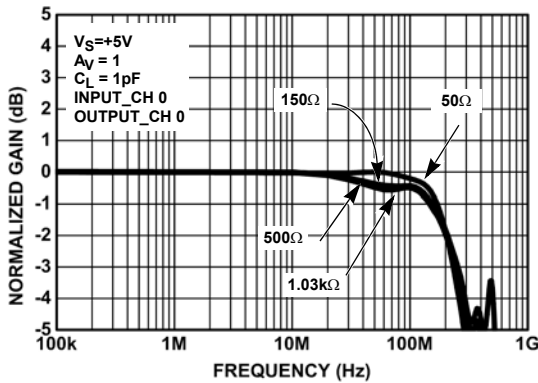

FIGURE 3. FREQUENCY RESPONSE - VARIOUS R_L , $A_V = 1$, MUX MODE

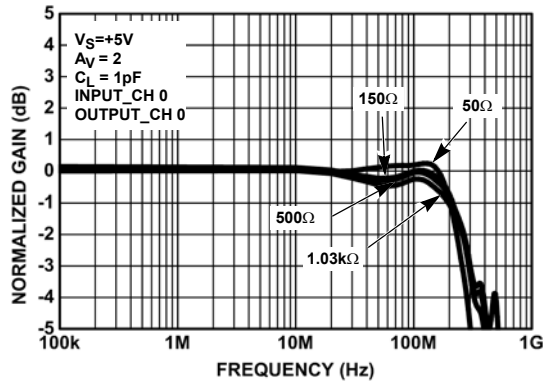

FIGURE 4. FREQUENCY RESPONSE - VARIOUS R_L , $A_V = 2$, MUX MODE

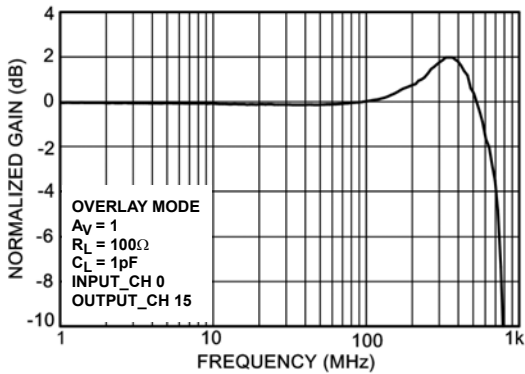

FIGURE 5. FREQUENCY RESPONSE - OVERLAY INPUT, $A_V = 1$

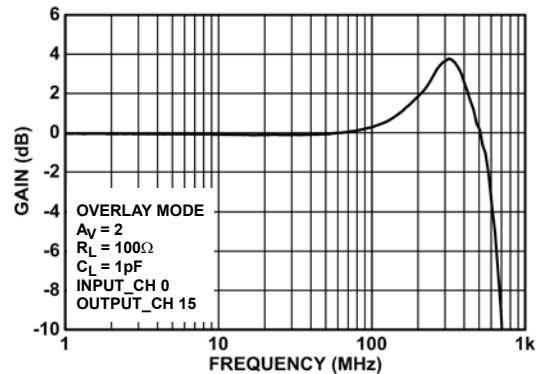

FIGURE 6. FREQUENCY RESPONSE - OVERLAY INPUT, $A_V = 2$

Typical Performance Curves (Continued)

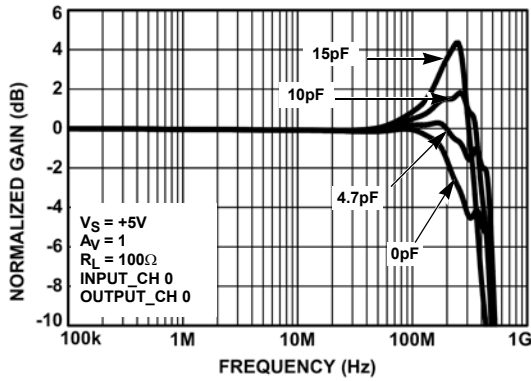

FIGURE 7. FREQUENCY RESPONSE - VARIOUS C_L , $A_V = 1$, BROADCAST MODE

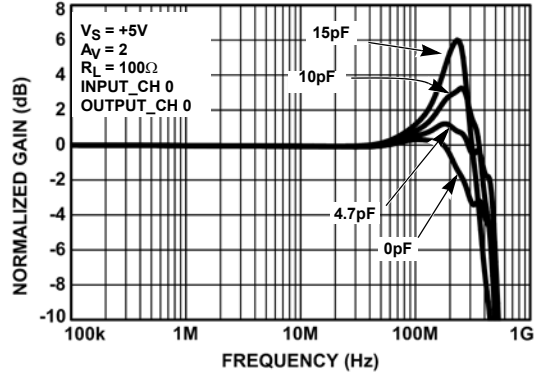

FIGURE 8. FREQUENCY RESPONSE - VARIOUS C_L , $A_V = 2$, BROADCAST MODE

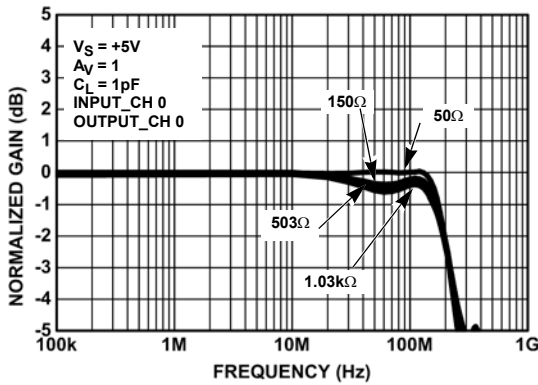

FIGURE 9A. FREQUENCY RESPONSE - VARIOUS R_L , $A_V = 1$, BROADCAST MODE

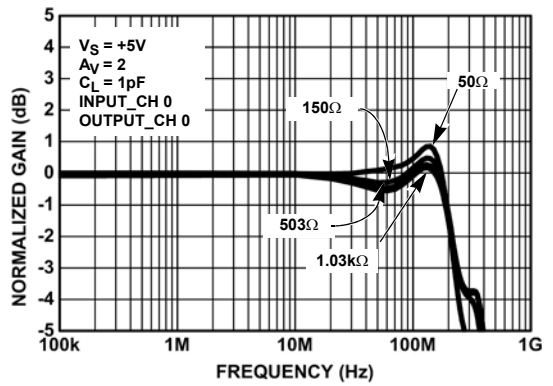

FIGURE 10. FREQUENCY RESPONSE - VARIOUS R_L , $A_V = 2$, BROADCAST MODE

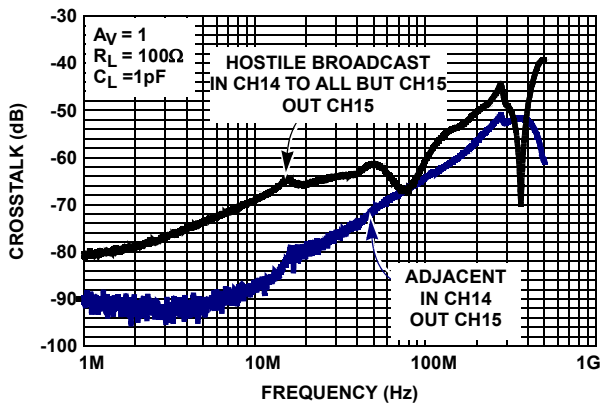

FIGURE 11. CROSSTALK - $A_V = 1$

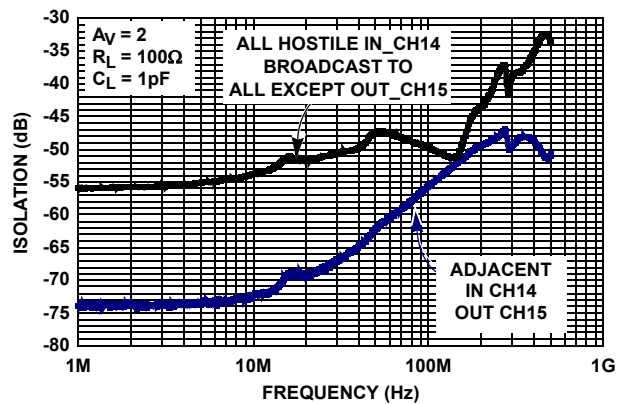

FIGURE 12. CROSSTALK - $A_V = 2$

Typical Performance Curves (Continued)

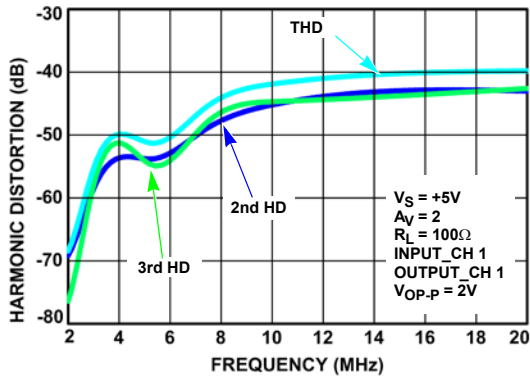

FIGURE 13. HARMONIC DISTORTION vs FREQUENCY

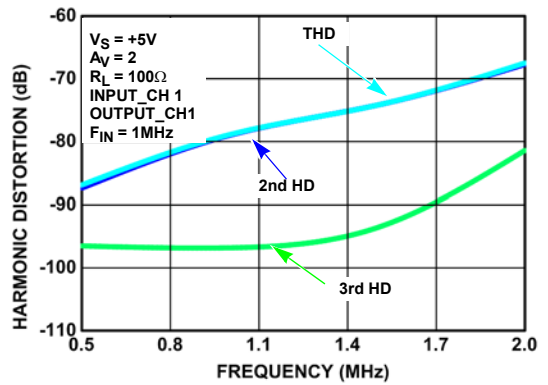

FIGURE 14. HARMONIC DISTORTION vs V_{OUT_P-P}

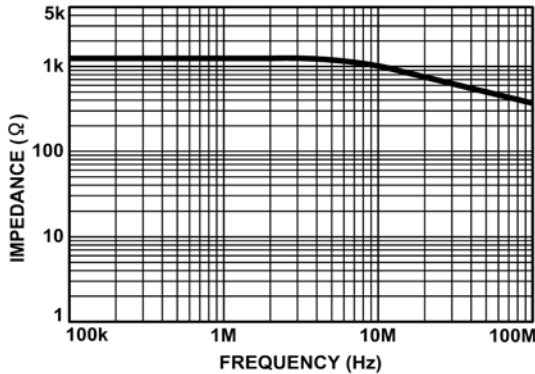

FIGURE 15. DISABLED OUTPUT IMPEDANCE

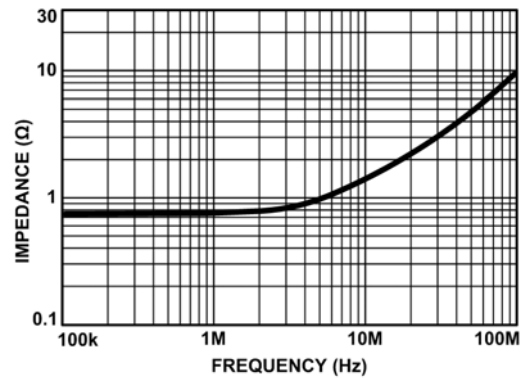

FIGURE 16. ENABLED OUTPUT IMPEDANCE

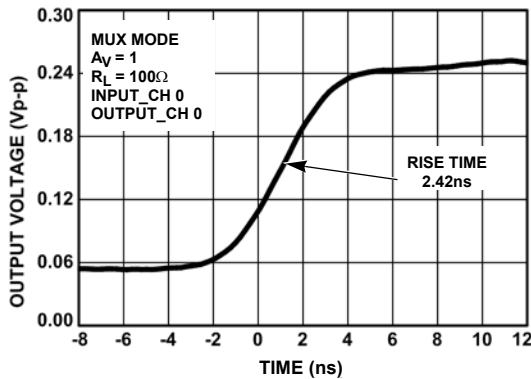

FIGURE 17. RISE TIME - $A_V = 1$

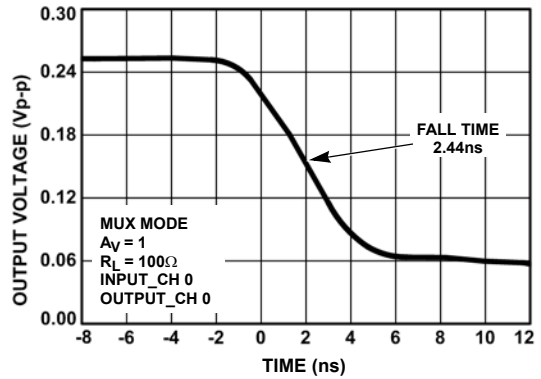

FIGURE 18. FALL TIME - $A_V = 1$

Typical Performance Curves (Continued)

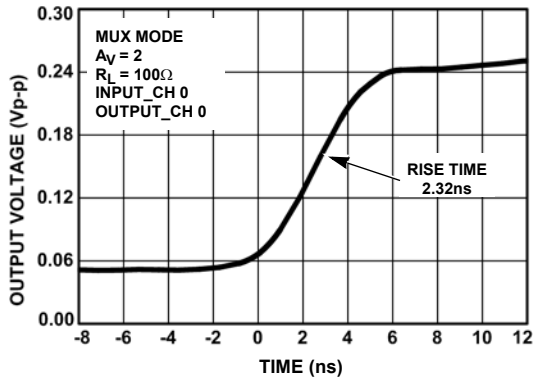

FIGURE 19. RISE TIME - $A_V = 2$

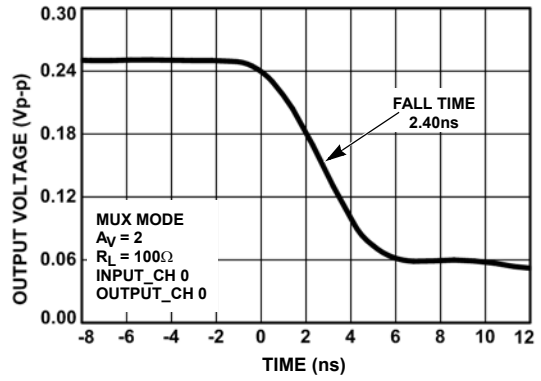

FIGURE 20. FALL TIME - $A_V = 2$

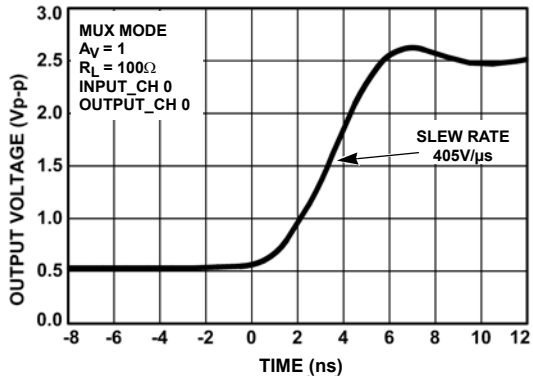

FIGURE 21. RISING SLEW RATE - $A_V = 1$

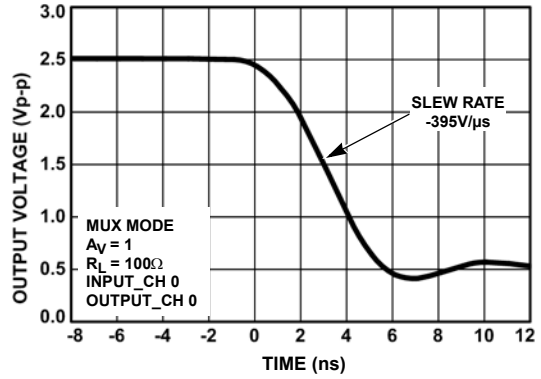

FIGURE 22. FALLING SLEW RATE - $A_V = 1$

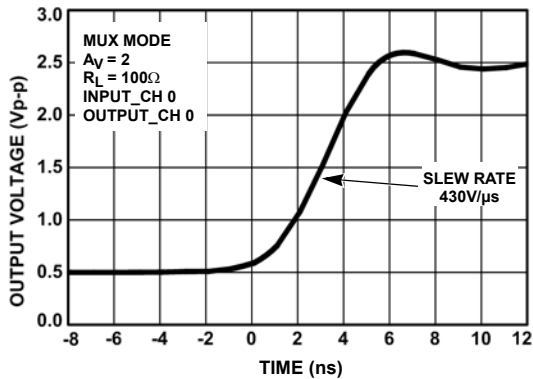

FIGURE 23. RISING SLEW RATE - $A_V = 2$

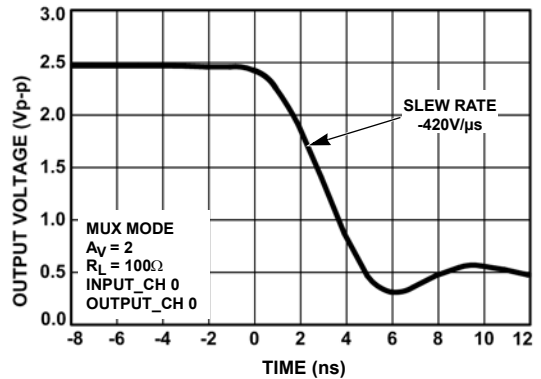

FIGURE 24. FALLING SLEW RATE - $A_V = 2$

Typical Performance Curves (Continued)

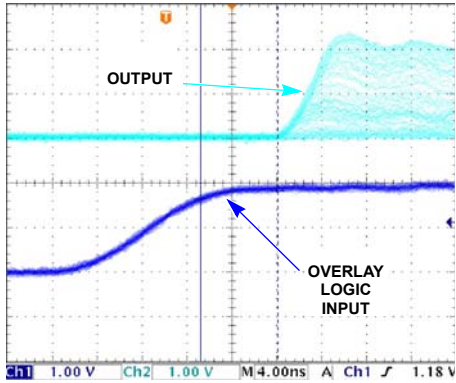

FIGURE 25. OVERLAY SWITCH TURN-ON DELAY TIME

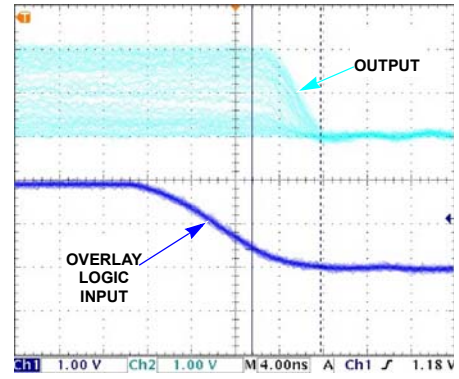

FIGURE 26. OVERLAY SWITCH TURN-OFF DELAY TIME

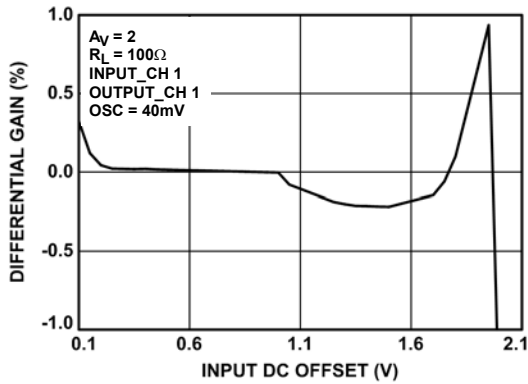

FIGURE 27. DIFFERENTIAL GAIN, $A_V = 2$

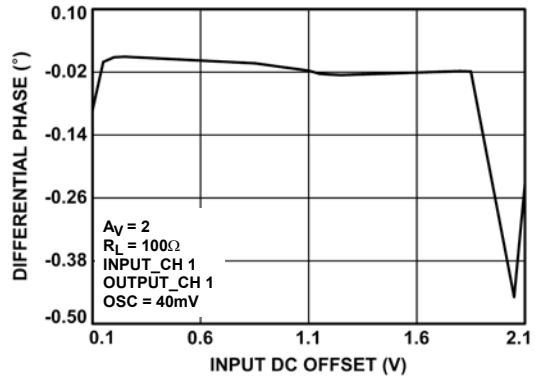

FIGURE 28. DIFFERENTIAL PHASE, $A_V = 2$

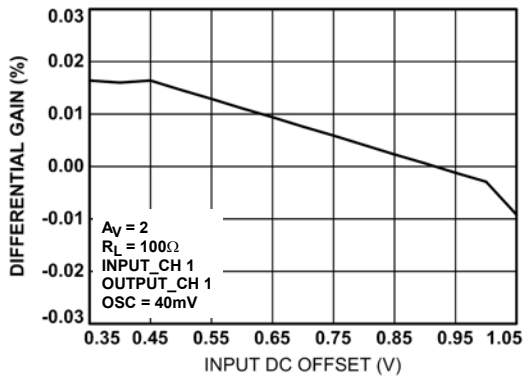

FIGURE 29. DIFFERENTIAL GAIN, $A_V = 2$

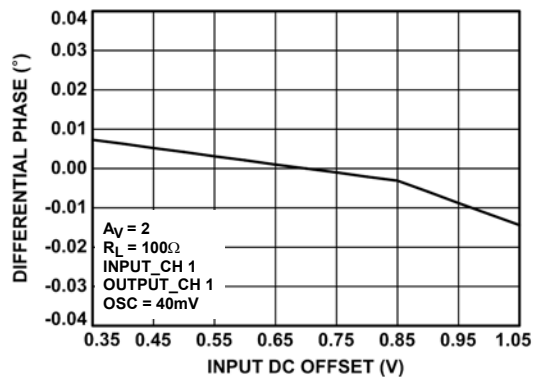

FIGURE 30. DIFFERENTIAL PHASE, $A_V = 2$

Typical Performance Curves (Continued)

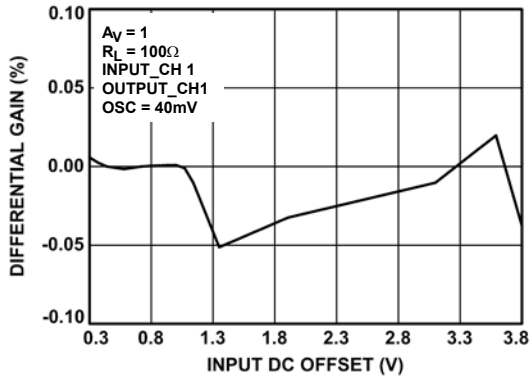

FIGURE 31. DIFFERENTIAL GAIN, $A_V = 1$

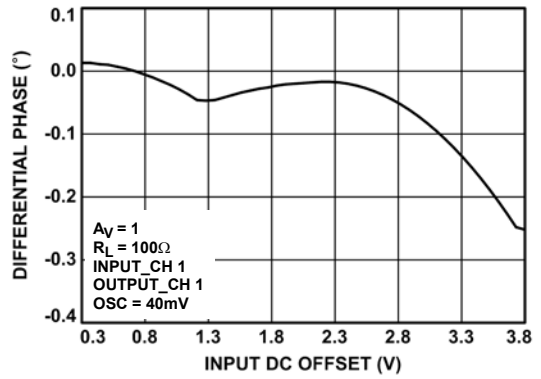

FIGURE 32. DIFFERENTIAL PHASE, $A_V = 1$

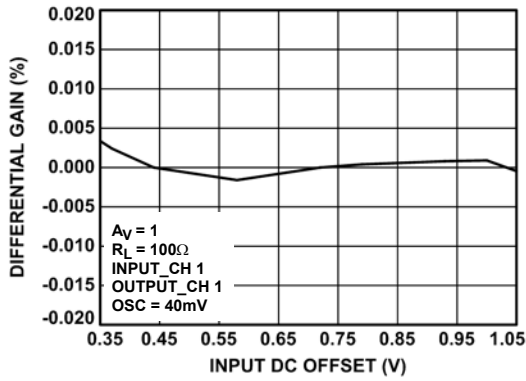

FIGURE 33. DIFFERENTIAL GAIN, $A_V = 1$

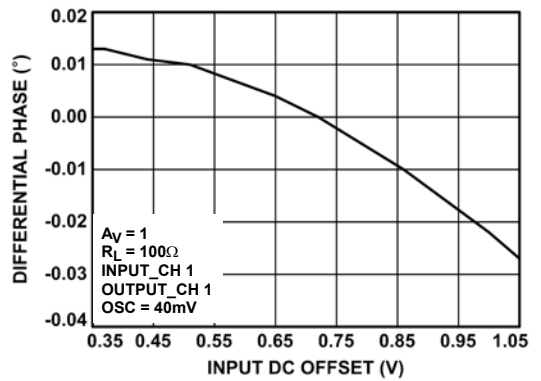

FIGURE 34. DIFFERENTIAL PHASE, $A_V = 1$

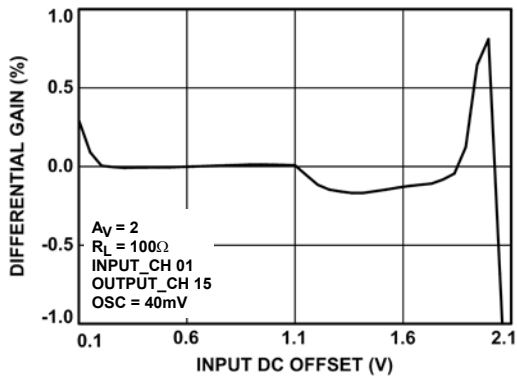

FIGURE 35. DIFFERENTIAL GAIN, $A_V = 2$

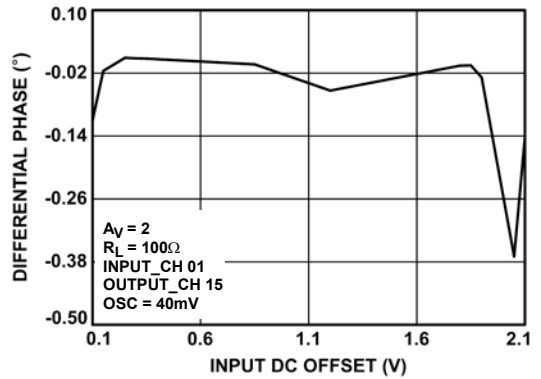

FIGURE 36. DIFFERENTIAL PHASE, $A_V = 2$

Typical Performance Curves (Continued)

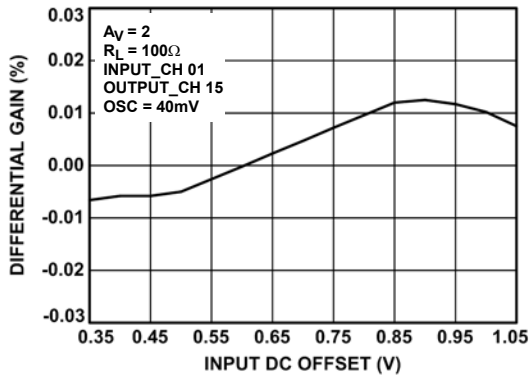

FIGURE 37. DIFFERENTIAL GAIN, $A_V = 2$

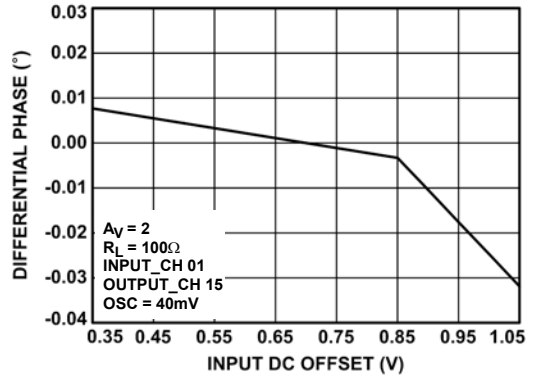

FIGURE 38. DIFFERENTIAL PHASE, $A_V = 2$

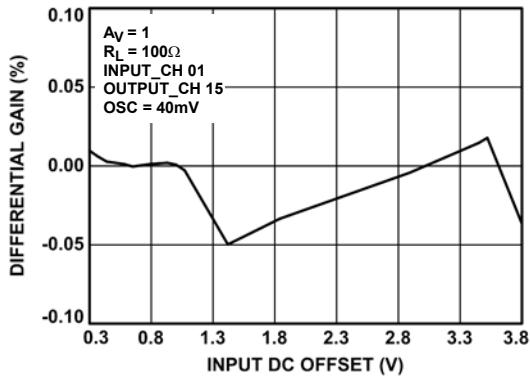

FIGURE 39. DIFFERENTIAL GAIN, $A_V = 1$

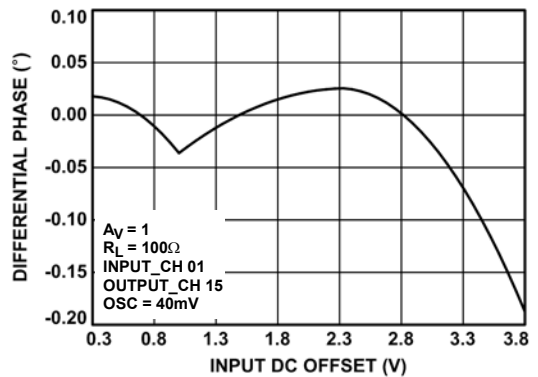

FIGURE 40. DIFFERENTIAL PHASE, $A_V = 1$

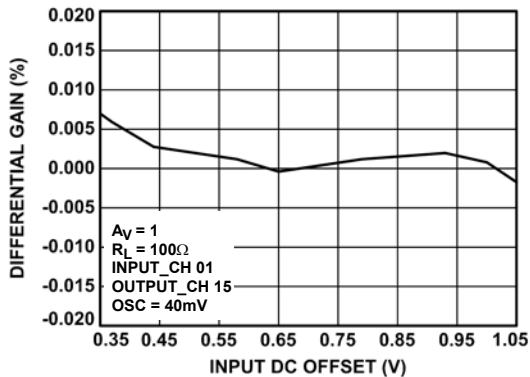

FIGURE 41. DIFFERENTIAL GAIN, $A_V = 1$

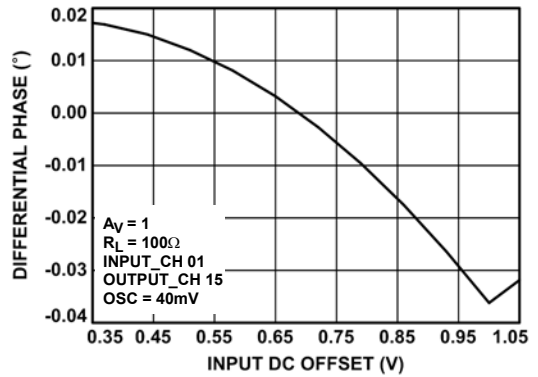

FIGURE 42. DIFFERENTIAL PHASE, $A_V = 1$

Typical Performance Curves (Continued)

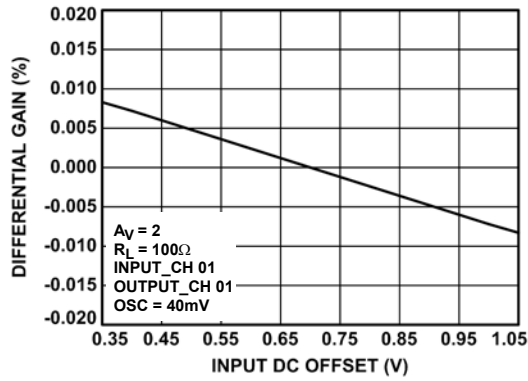

FIGURE 43. DIFFERENTIAL GAIN, OVERLAY, $A_V = 2$

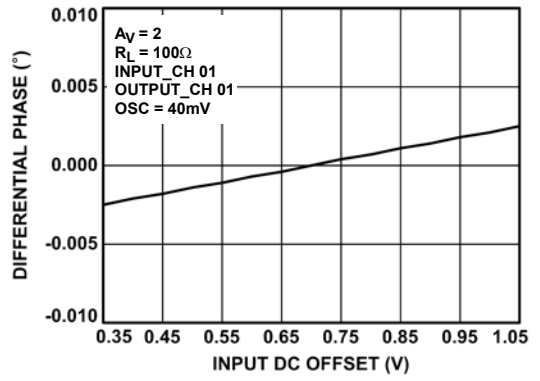

FIGURE 44. DIFFERENTIAL PHASE, OVERLAY, $A_V = 2$

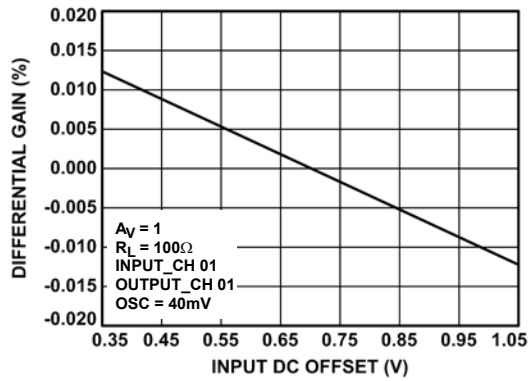

FIGURE 45. DIFFERENTIAL GAIN, OVERLAY, $A_V = 1$

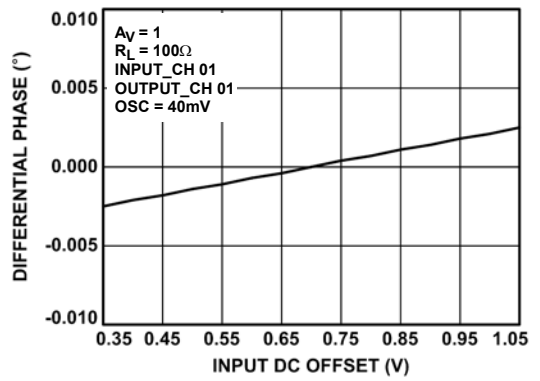

FIGURE 46. DIFFERENTIAL PHASE, OVERLAY, $A_V = 1$

ISL59530

3dB Bandwidth, MUX Mode, $A_V = 1$, $R_L = 100\Omega$ [MHz]

		INPUT CHANNELS															
		0	1	2	3	4	5	6	7	8	9	10	11	12	13	14	15
OUTPUT CHANNELS	0	255	229	229	210	222	221	224	190	169	152	233	190	212	189	207	166
	1	244	217						180	168						193	160
	2	257		235					186	171					204		169
	3	264			217				183	175				219			171
	4	255				220			174	177			202				167
	5	253					218		176	177		237					173
	6	247						226	171	178	157						170
	7	253	227	235	218	223	228	230	174	184	163	240	223	219	217	211	178
	8	255	236	240	239	223	236	231	175	187	168	241	242	222	235	213	183
	9	241						210	169	188	165						182
	10	235					236		168	186		230					185
	11	223				207			164	188			225				186
	12	220			209				161	192				205			185
	13	211		214					160	192					224		189
	14	199	212						160	194						197	193
	15	193	217	207	202	185	216	186	222	197	177	225	217	198	223	197	238

3dB Bandwidth, MUX Mode, $A_V = 2$, $R_L = 100\Omega$ [MHz]

		INPUT CHANNELS															
		0	1	2	3	4	5	6	7	8	9	10	11	12	13	14	15
OUTPUT CHANNELS	0	295	316	290	397	384	405	395	220	288	240	299	250	385	234	396	188
	1	268	290						211	183						291	183
	2	277		300					216	192					289		196
	3	279			408				213	196				392			196
	4	269				391			201	192			402				192
	5	263					407		201	196		298					200
	6	259						404	196	196	283						200
	7	263	411	307	402	387	412	398	201	205	407	307	402	387	413	398	211
	8	262	407	308	402	383	412	394	203	212	411	300	403	385	415	394	216
	9	253						388	194	210	410						214
	10	253					417		194	215		293					216
	11	246				385			187	213			412				217
	12	241			412				184	216				391			225
	13	236		272					182	220					419		225
	14	233	279						178	220						396	230
	15	227	274	244	396	367	407	230	183	223	324	276	400	379	413	385	293

3dB Bandwidth, Broadcast Mode, $A_V = 1$, $R_L = 100\Omega$ [MHz]

		INPUT CHANNELS															
		0	1	2	3	4	5	6	7	8	9	10	11	12	13	14	15
OUTPUT CHANNELS	0	215	198	195	183	184	188	172	178	151	145	157	145	140	146	144	158
	1	214	195						174	152						144	158
	2	210		188					171	153					147		159
	3	212			178				171	157				143			164
	4	206				174			169	157			150				164
	5	203					177		165	159		161					164
	6	201						156	163	159	151						164
	7	204	187	182	170	170	175	160	167	167	156	168	157	151	158	154	170
	8	204	187	183	172	171	176	161	167	171	160	172	160	155	161	159	175
	9	202						157	164	170	160						174
	10	196					170		160	169		169					178
	11	194				161			157	171			160				174
	12	193			162				156	171				156			178
	13	191		170					151	174					164		178
	14	189	172						151	175						162	178
15	187	173	167	157	155	161	149	153	178	167	179	167	160	166	164	181	

3dB Bandwidth, Broadcast Mode, $A_V = 2$, $R_L = 100\Omega$ [MHz]

		INPUT CHANNELS															
		0	1	2	3	4	5	6	7	8	9	10	11	12	13	14	15
OUTPUT CHANNELS	0	234	216	209	199	204	205	190	196	169	160	172	162	158	163	161	178
	1	232	215						193	169						161	178
	2	228		204					189	171					164		178
	3	229			196				191	175				163			182
	4	223				193			186	177			168				183
	5	219					192		183	177		177					183
	6	217						174	181	178	167						183
	7	220	204	198	189	190	192	175	183	184	173	184	174	169	174	172	189
	8	220	205	199	190	191	193	177	184	187	178	188	178	173	178	178	193
	9	218						174	181	188	178						193
	10	220					185		176	186		187					192
	11	212				179			174	188			177				192
	12	211			179				174	192				176			195
	13	209		187					170	192					181		195
	14	208	191						167	194						181	196
15	205	191	184	172	171	176	160	166	197	185	195	184	179	185	182	198	

Block Diagram

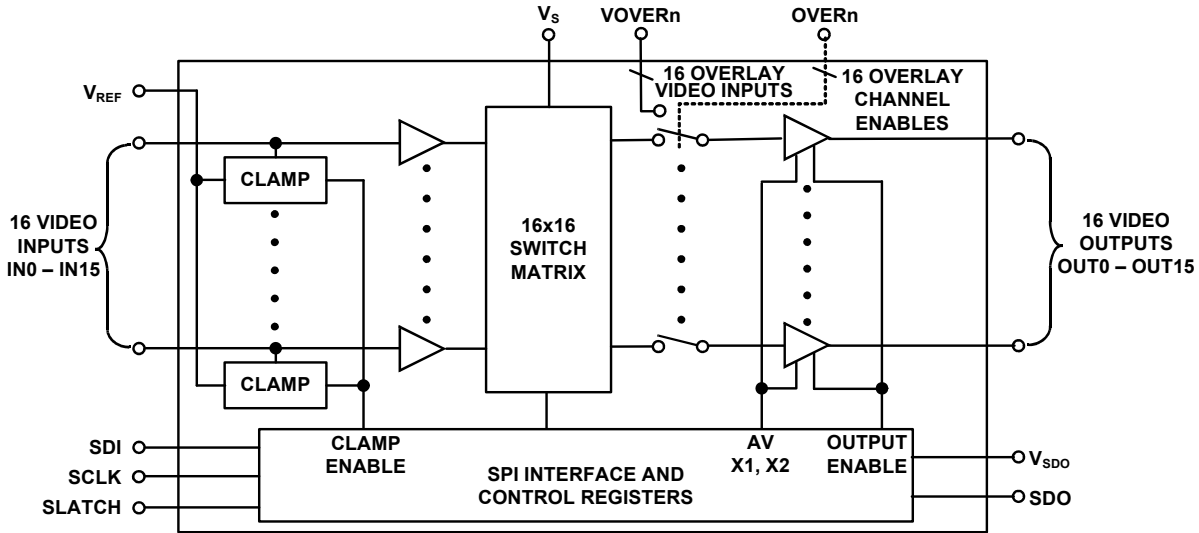

General Description

The ISL59530 is a 16x16 integrated video crosspoint switch matrix with input and output buffers and On-Screen Display (OSD) insertion. This device operates from a single +5V supply. Any output can be generated from any of the 16 input video signal sources, and each output can have OSD information inserted through a dedicated, fast 2:1 mux located before the output buffer. There is also a Broadcast mode allowing any one input to be broadcast to all 16 outputs. A DC-restore clamp function enables the ISL59530 to AC-couple incoming video.

The ISL59530 offers a -3dB signal bandwidth of 300MHz. Differential gain and differential phase of 0.025% and 0.05° respectively, along with 0.1dB flatness out to 50MHz make this ideal for multiplexing composite NTSC and PAL signals. The switch matrix configuration and output buffer gain are programmed through an SPI/QSPI™-compatible, three-wire serial interface. The ISL59530 interface is designed to facilitate both fast initialization and configuration changes. On power-up, all outputs are initialized to the disabled state to avoid output conflicts in the user's system.

Digital Interface

The ISL59530 uses a serial interface to program the configuration registers. The serial interface uses three signals (SCLK, SDI, and SLATCH) for programming the ISL59530, while a fourth signal (SDO) enables optional daisy-chaining of multiple devices. The serial clock can run at up to 5MHz (5Mbits/s).

Serial Interface

The ISL59530 is programmed through a simple serial interface. Data on the SDI (serial data input) pin is shifted into a 16-bit shift register on the rising edge of the SCLK (serial clock) signal (this is continuously done regardless of the state of the SLATCH signal). The LSB (Bit 0) is loaded first and the MSB (Bit 15) is loaded last (see the "Serial Timing Diagram" on page 20). After all 16 bits of data have been loaded into the shift register, the rising edge of SLATCH updates the internal registers.

While the ISL59530 has an SDO (Serial Data Out) pin, it does not have a register readback feature. The data on the SDO pin is an exact replica of the incoming data on the SDI pin, delayed by 15.5 SCLKs (an input bit is latched on the rising edge of SLCK, and is output on SDO on the falling edge of SLCK 15.5 SCLKs later). Multiple ISL59530's can be daisy-chained by connecting the SDO of one to the SDI of the other, with SCLK and SLATCH common to all the daisy-chained parts. After all the serial data is transmitted (16 bits*n devices = 16*n SCLKs), the rising edge of SLATCH will update the configuration registers of all n devices simultaneously.

The "Serial Timing Diagram" on page 20 and Table 1 show the timing requirements for the serial interface.

Serial Timing Diagram

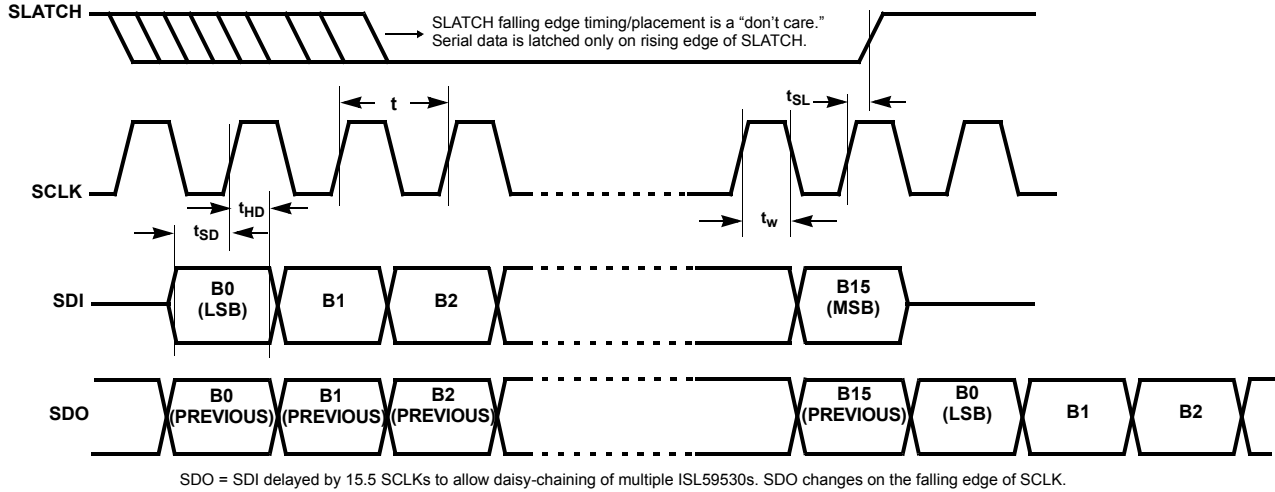

TABLE 1. SERIAL TIMING PARAMETERS

PARAMETER	RECOMMENDED OPERATING RANGE	DESCRIPTION
t	≥200ns	SCLK period
t _W	0.50*t	Clock Pulse Width
t _{SD}	≥20ns	Data Setup Time
t _{HD}	≥20ns	Data Hold Time
t _{SL}	≥20ns	Final SCLK rising edge (latching B15) to SLATCH rising edge

Programming Model

The ISL59530 is configured by a series of 16-bit serial control words. The three MSBs (B15 through B13) of each serial word determine the basic command:

TABLE 2. COMMAND FORMAT

B15	B14	B13	COMMAND	NUMBER OF WRITES
0	0	0	INPUT/OUTPUT: Maps input channels to output channels	16 (1 channel per write)
0	0	1	OUTPUT ENABLE: Output enable for individual channels	4 (4 channels per write)
0	1	0	GAIN SET: Gain (x1 or x2) for each channel	4 (4 channels per write)
0	1	1	BROADCAST: Enables broadcast mode and selects the input channel to be broadcast to all output channels	1
1	1	1	CONTROL: Clamp on/off, operational/standby mode, and global output enable/disable	1

Mapping Inputs to Outputs

Inputs are mapped to their desired outputs using the input/output control word. Its format is:

TABLE 3. INPUT/OUTPUT WORD

B15	B14	B13	B12	B11	B10	B9	B8	B7	B6	B5	B4	B3	B2	B1	B0
0	0	0	I ₃	I ₂	I ₁	I ₀	0	0	0	0	O ₃	O ₂	O ₁	O ₀	0

I₃:I₀ form the 4-bit word indicating the input channel (0 to 15), and O₃:O₀ determine the output channel which that input channel will map to. One input can be mapped to one or multiple outputs. To fully program the ISL59530, 16 INPUT/OUTPUT words must be transmitted - one for each input channel.

Note: Broadcast Mode must be disabled when configuring input/output mapping. INPUT/OUTPUT words transmitted while in Broadcast Mode will not be processed correctly and result in corrupt channel mapping when Broadcast Mode is disabled.

Enabling Outputs

The output enable control word is used to enable individual outputs. There are 16 channels to configure, so this is accomplished by writing 4 serial words, each controlling a bank of four outputs at a time. The bank is selected by bits B9 and B8. The output enable control word format is:

TABLE 4. OUTPUT ENABLE FORMAT

B15	B14	B13	B12	B11	B10	B9	B8	B7	B6	B5	B4	B3	B2	B1	B0
0	0	1	0	0	0	0	0		O ₃		O ₂		O ₁		O ₀
0	0	1	0	0	0	0	1		O ₇		O ₆		O ₅		O ₄
0	0	1	0	0	0	1	0		O ₁₁		O ₁₀		O ₉		O ₈
0	0	1	0	0	0	1	1		O ₁₅		O ₁₄		O ₁₃		O ₁₂

Setting the O_N bit = 0 tri-states the output. Setting the O_N bit = 1 enables the output if the Global Output Enable bit is also set (the individual output enable bits are ANDed with the Global Output Enable bit before they are sent to the output stage).

Setting the Gain

The gain of each output may be set to x1 or x2 using the Gain Set word. It is in the same format as the output enable control word:

TABLE 5. GAIN SET FORMAT

B15	B14	B13	B12	B11	B10	B9	B8	B7	B6	B5	B4	B3	B2	B1	B0
0	1	0	0	0	0	0	0		G ₃		G ₂		G ₁		G ₀
0	1	0	0	0	0	0	1		G ₇		G ₆		G ₅		G ₄
0	1	0	0	0	0	1	0		G ₁₁		G ₁₀		G ₉		G ₈
0	1	0	0	0	0	1	1		G ₁₅		G ₁₄		G ₁₃		G ₁₂

Set G_N = 0 for a gain of x1 or 1 for a gain of x2.

Broadcast Mode

The Broadcast Mode routes one input to all 16 outputs. The broadcast control word is:

TABLE 6. BROADCAST FORMAT

B15	B14	B13	B12	B11	B10	B9	B8	B7	B6	B5	B4	B3	B2	B1	B0
0	1	1	I ₃	I ₂	I ₁	I ₀	0	0	0	0	0	0	0	0	Enable Broadcast 0: Broadcast Mode Disabled 1: Broadcast Mode Enabled

I₃:I₀ form the 4-bit word indicating the input channel (0 to 15) to be sent to all 16 outputs. Set the Enable Broadcast bit (B0) = 1 to enable Broadcast Mode, or to 0 to disable Broadcast Mode. When Broadcast Mode is disabled, the previous channel assignments are restored.

Control Word

The ISL59530's power-on reset disables all outputs and places the part in a low-power standby mode. To enable the device, the following control word should be sent:

TABLE 7. CONTROL WORD FORMAT

B15	B14	B13	B12	B11	B10	B9	B8	B7	B6	B5	B4	B3	B2	B1	B0
1	1	1	0	0	0	Clamp 0: Clamp Disabled 1: Clamp Enabled	0	0	0	0	0	0	0	Power 0: Standby 1: Operational	Global Output Enable 0: All outputs tri-stated 1: Individual Output Enable bits control outputs

The Clamp bit enables the input clamp function, forcing the AC-coupled signal's most negative point to be equal to V_{REF}.

Note: The Clamp bit turns the DC-restore clamp function on or off for *all* channels - there is no DC-restore on/off control for individual channels. The DC-restore function only works with signals with sync tips (composite video). Signals that do not have sync tips (the Chroma/C signal in S-video and the Pb, Pr signals in Component video), will be severely distorted if run through a DC-restore/clamp function.

For this reason, the ISL59530 must be in DC-coupled mode (Clamp Disabled) to be compatible with S-video and component video signals.

Bandwidth Considerations

Wide frequency response (high bandwidth) in a video system means better video resolution. Four sets of frequency response curves are shown in Figure 47. Depending on the switch configurations and the routing (the path from the input to the output), bandwidth can vary between 100MHz and 350MHz. A short discussion of the trade-offs — including matrix configuration, output buffer gain selection, channel selection, and loading follows.

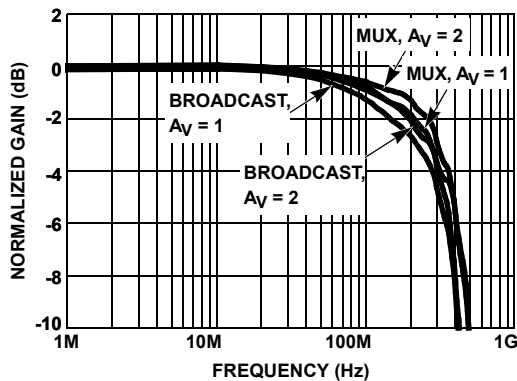

FIGURE 47. FREQUENCY RESPONSE FOR VARIOUS MODES

In multiplexer mode, one input typically drives one output channel, while in broadcast mode, one input drives all 16 outputs. As the number of outputs driven increases, the parasitic loading on that input increases. Broadcast Mode is the worst-case, where the capacitance of all 16 channels loads one input, reducing the overall bandwidth. In addition, due to internal device compensation, an output buffer gain of x2 has higher bandwidth than a gain of x1. Therefore, the highest bandwidth configuration is multiplexer mode (with each input mapped to only one output) and an output buffer gain of x2.

The relative locations of the input and output channels also have significant impact on the device bandwidth (due to the layout of the ISL59530 silicon). When the input and output channels are further away, there are additional parasitics as a result of the additional routing, resulting in lower bandwidth.

The bandwidth does not change significantly with resistive loading, as shown in the “Typical Performance Curves” beginning on page 9. However several of the curves demonstrate that frequency response is sensitive to capacitance loading. This is most significant when laying out the PCB. If the PCB trace length between the output of the crosspoint switch and the back-termination resistor is not minimized, the additional parasitic capacitance will result in some peaking and eventually a reduction in overall bandwidth.

Linear Operating Region

In addition to bandwidth optimization, to get the best linearity the ISL59530 should be configured to operate in its most linear operating region. Figure 48 shows the differential gain curve. The ISL59530 is a single supply 5V design with its most linear region between 0.1 and 2V. This range is fine for most video signals whose nominal signal amplitude is 1V. The most negative input level (the sync tip for composite video) should be maintained at 0.3V or above for best operation.

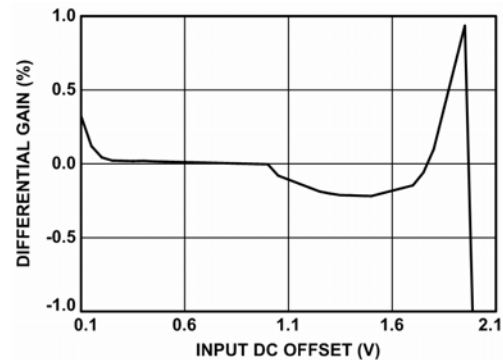

FIGURE 48. DIFFERENTIAL GAIN RESPONSE

In a DC-coupled application, it is the system designer’s responsibility to ensure that the video signal is always in the optimum range.

When AC coupling, the ISL59530’s Clamp (also called “DC-restore”) function automatically and continuously adjusts the DC level so that the most negative portion of the video is always equal to V_{REF} .

A discussion of the benefits of the DC restoration function begins by understanding the Clamp circuit shown in Figure 49. The incoming video signal is typically terminated into 75Ω , then AC-coupled through C_1 , at which point it is connected to the base of the buffer’s differential pair. These components form the video path.

The Clamp function consists of Q_1 , D_1 , Q_2 , D_2 , the two current sources, and the 3 switches controlled by the Clamp Enable signal. The V_{REF} voltage is level-shifted up two diode drops (Q_1 and D_1) to the base of Q_2 . If the voltage at the cathode of D_2 goes below V_{REF} , Q_2 and D_2 will turn on, keeping the IN_x voltage at V_{REF} . If the voltage at IN_x is greater than V_{REF} , Q_2 and D_2 are off and the IN_x node is high impedance. This is how the clamp function forces the lowest portion of the video signal (the sync tip) to always be equal to or greater than V_{REF} .

To make sure that the sync tip is always *equal to* (not equal to or greater than) V_{REF} ; i_1 is constantly sinking $\sim 2\mu A$ of current from C_1 . This causes each sync tip to be slightly lower voltage than the previous sync tip, causing Q_2 and D_2 to turn on at each sync tip and raise the voltage to V_{REF} . The $2\mu A$ pull-down with a $0.1\mu F$ capacitor and a 15kHz HSYNC frequency results in 1.3mV of “droop” across every line, or 0.2% of the video signal. Because 1.3mV is only 0.2% of a 0.7V video signal, this droop is imperceptible to the human eye.

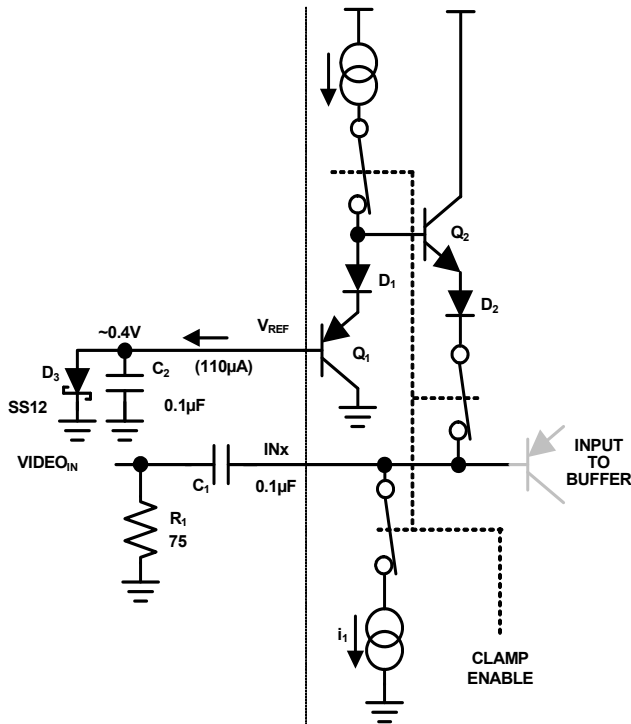

FIGURE 49. DC-RESTORE BLOCK DIAGRAM

This is how the video is “DC-restored” after being AC-coupled into the ISL59530. The sync tip voltage will be equal to V_{REF} on the right side of C_1 , regardless of the DC level of the video on the left side of C_1 . Due to various sources of offset in the actual clamp function, the actual sync tip level is typically about 75mV higher than V_{REF} (for $V_{REF} = 0.4V$).

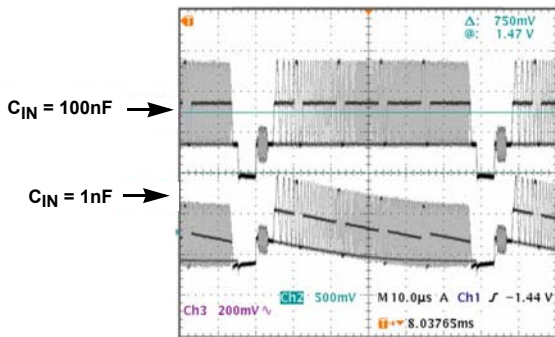

FIGURE 50. DC-RESTORE VIDEO WAVEFORMS

It is important to choose the correct value for C_{IN} . Too small a value will generate too much droop, and the image will be visibly darker on the right than on the left. A C_{IN} value that is too large may cause the clamp to fail to converge. The droop rate (dV/dt) is i_1/C_{IN} volts/second. In general, the droop voltage should be limited to <1 IRE over a period of one line of video; so for 1 IRE = 7mV, $I_B = 10\mu A$ maximum, and an NTSC waveform we will set $C_{IN} > 10\mu A * 60\mu s / 7mV = 0.086\mu F$. Figure 50 shows the result of $C_{IN} = 0.1\mu F$ delivering acceptable droop and $C_{IN} = 0.001\mu F$ producing excessive droop.

When the clamp function is disabled in the CONTROL register (Clamp = 0) to allow DC-coupled operation, the I_{CLAMP} current sinks/sources are disabled and the input passes through the DC-restore block unaffected. In this application, V_{REF} may be tied to GND.

Overlay Operation

The ISL59530 features an overlay feature that allows an external video signal or DC level to be inserted in place of that output channel's video. When the $OVER_N$ signal is taken high, the output signal on the OUT_N pin is replaced with the signal on the $VOVER_N$ pin.

There are several ways the overlay feature can be used. Toggling the $OVER_N$ signal at the frame rate or slower will replace the video frame(s) on the OUT_N pin with the video supplied on the $VOVER_N$ pin.

Another option (for OSD displays, for example), is to put a DC level on the $VOVER_N$ line and toggle the $OVER_N$ signal at the pixel rate to create a monochrome image “overlayed” on Channel N's output signal.

Finally, by enabling the $OVER_N$ signal for some portion of each line over a certain amount of lines, a picture-in-picture function can be constructed.

It's important to note that the overlay inputs do not have the DC-restore function previously described - the overlay signal is DC-coupled into the output. It is the system designer's responsibility to ensure that the video levels are in the ISL59530's linear region and matching the output channel's offset and amplitude. One easy way to do this is to run the video to be overlaid through one of the ISL59530's unused channels and then into the $VOVER_N$ input.

The $OVER_N$ pins all have weak pull-downs, so if they are unused, they can either be left unconnected or tied to GND.

Power Dissipation and Thermal Resistance

With a large number of switches, it is possible to exceed the $+150^\circ C$ absolute maximum junction temperature under certain load current conditions. Therefore, it is important to calculate the maximum junction temperature for an application to determine if load conditions or package types need to be modified to assure operation of the crosspoint switch in a safe operating area.

The maximum power dissipation allowed in a package is determined according to Equation 1:

$$PD_{MAX} = \frac{T_{JMAX} - T_{AMAX}}{\theta_{JA}} \quad (EQ. 1)$$

Where:

- T_{JMAX} = Maximum junction temperature = $+125^\circ C$
- T_{AMAX} = Maximum ambient temperature = $+85^\circ C$
- θ_{JA} = Thermal resistance of the package

The maximum power dissipation actually produced by an IC is the total quiescent supply current times the total power supply voltage, plus the power in the IC due to the load, or:

$$PD_{MAX} = V_S \times I_{SMAX} + \sum_{i=1}^n (V_S - V_{OUTi}) \times \frac{V_{OUTi}}{R_{Li}} \quad (\text{EQ. 2})$$

Where:

- V_S = Supply voltage = 5V
- I_{SMAX} = Maximum quiescent supply current = 360mA
- V_{OUT} = Maximum output voltage of the application = 2V
- R_{LOAD} = Load resistance tied to ground = 150
- n = 1 to 16 channels

$$PD_{MAX} = V_S \times I_{SMAX} + \sum_{i=1}^n (V_S - V_{OUTi}) \times \frac{V_{OUTi}}{R_{Li}} = 2.44W \quad (\text{EQ. 3})$$

The required θ_{JA} to dissipate 2.44W is:

$$\theta_{JA} = \frac{T_{JMAX} - T_{AMAX}}{PD_{MAX}} = 16.4(^{\circ}\text{C/W}) \quad (\text{EQ. 4})$$

Table 8 shows θ_{JA} thermal resistance results with a Wakefield heatsink and without heatsink and various airflow. As the thermal resistance shows, the required thermal resistance depends on the maximum ambient temperature.

TABLE 8. θ_{JA} THERMAL RESISTANCE [$^{\circ}\text{C/W}$]

AIRFLOW [LFM]	0	250	500	750
No Heatsink	18	14.3	13.0	12.6
Wakefield 658-25AB Heatsink	16.0	7.0	6.0	4.7

All Intersil U.S. products are manufactured, assembled and tested utilizing ISO9000 quality systems. Intersil Corporation's quality certifications can be viewed at www.intersil.com/design/quality

Intersil products are sold by description only. Intersil Corporation reserves the right to make changes in circuit design, software and/or specifications at any time without notice. Accordingly, the reader is cautioned to verify that data sheets are current before placing orders. Information furnished by Intersil is believed to be accurate and reliable. However, no responsibility is assumed by Intersil or its subsidiaries for its use; nor for any infringements of patents or other rights of third parties which may result from its use. No license is granted by implication or otherwise under any patent or patent rights of Intersil or its subsidiaries.

For information regarding Intersil Corporation and its products, see www.intersil.com

Package Outline Drawing

L72.10x10C

72 LEAD QUAD FLAT NO-LEAD PLASTIC PACKAGE (PUNCH QFN)

Rev 0, 7/07

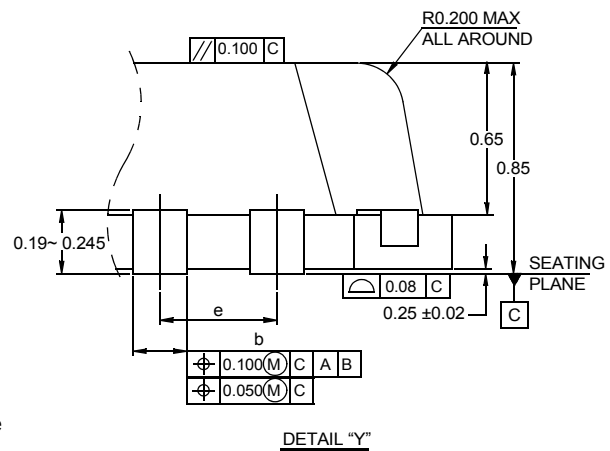
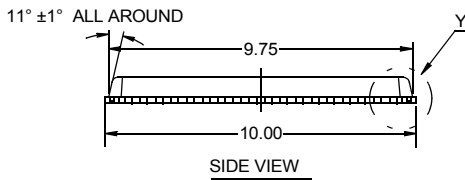
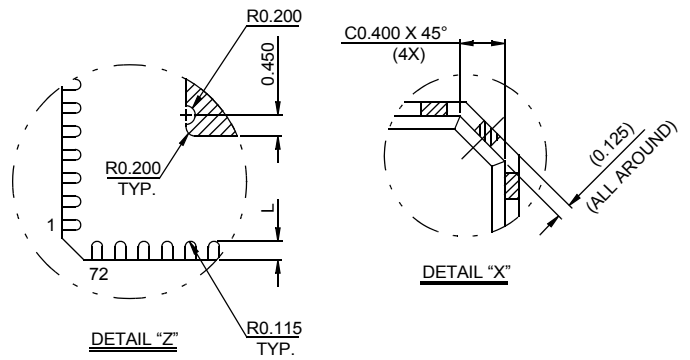
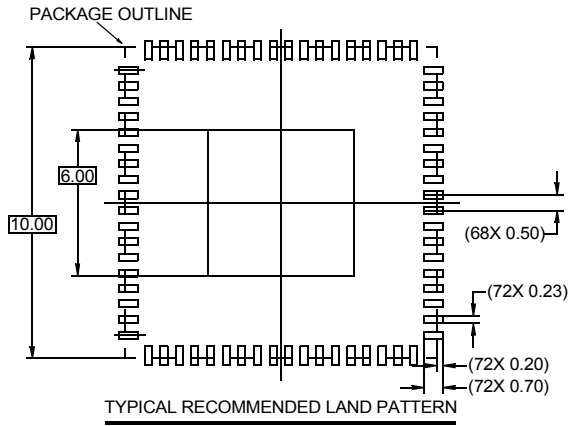
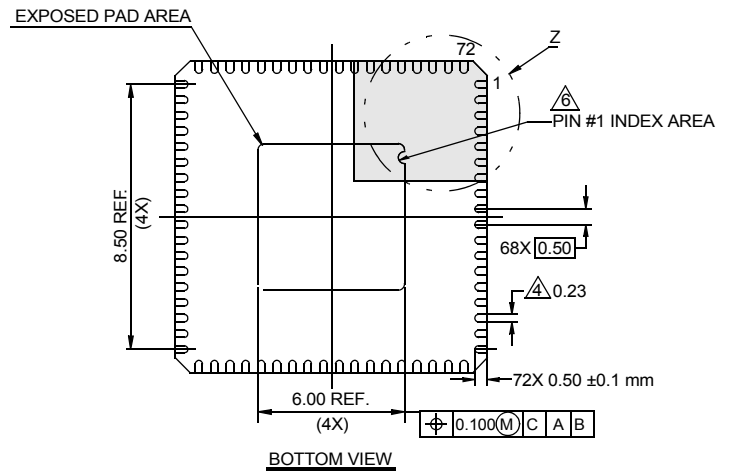
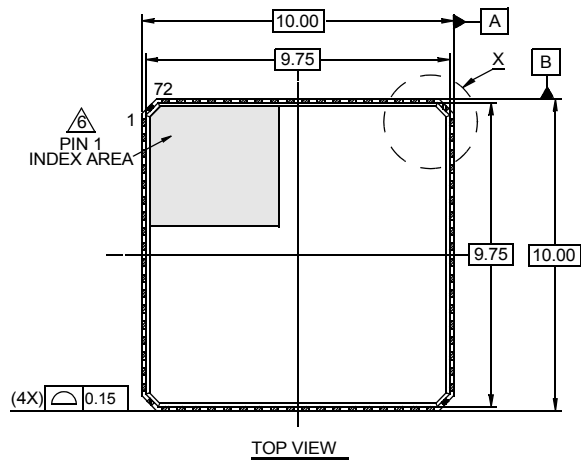

NOTES:

1. Dimensions are in millimeters.
Dimensions in () for Reference Only.
2. Dimensioning and tolerancing conform to JESD-MO220.
3. Unless otherwise specified, tolerance : Decimal ± 0.05 ;
body tolerance: $\pm 0.1\text{mm}$
4. Dimension b applies to the metallized terminal and is measured
between 0.15mm and 0.30mm from the terminal tip.
5. Tiebar shown (if present) is a non-functional feature.
6. The configuration of the pin #1 identifier is optional, but must be
located within the zone indicated. The pin #1 identifier may be
either a mold or mark feature.

Package Outline Drawing

V356.27x27B

356 BALL PLASTIC BALL GRID ARRAY PACKAGE (PBGA)

Rev 2, 10/10

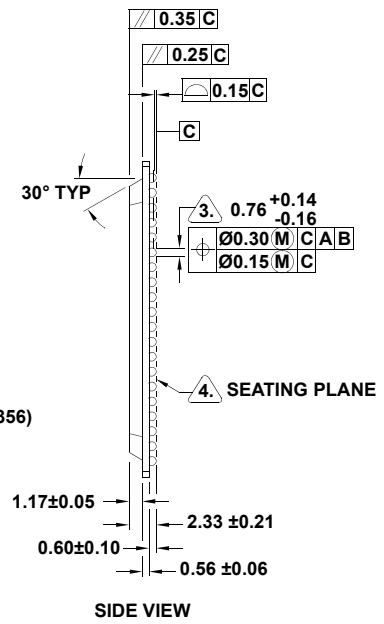
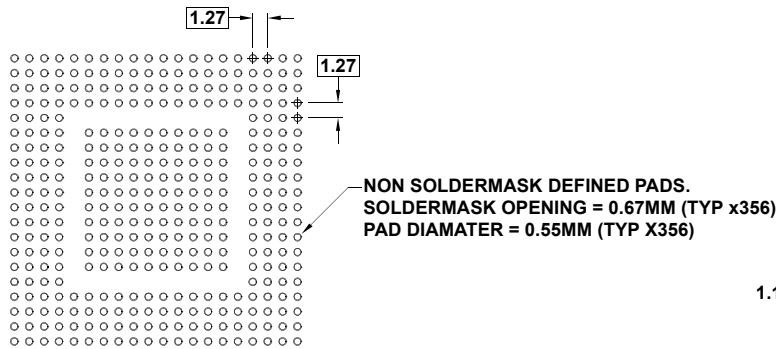
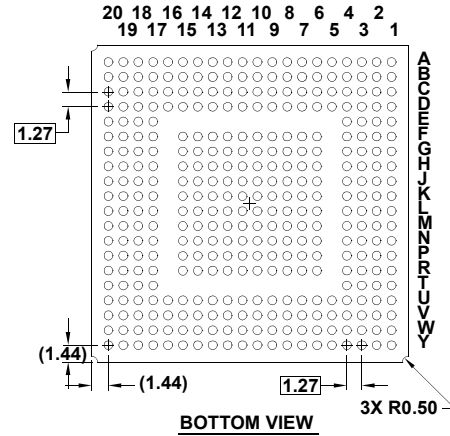
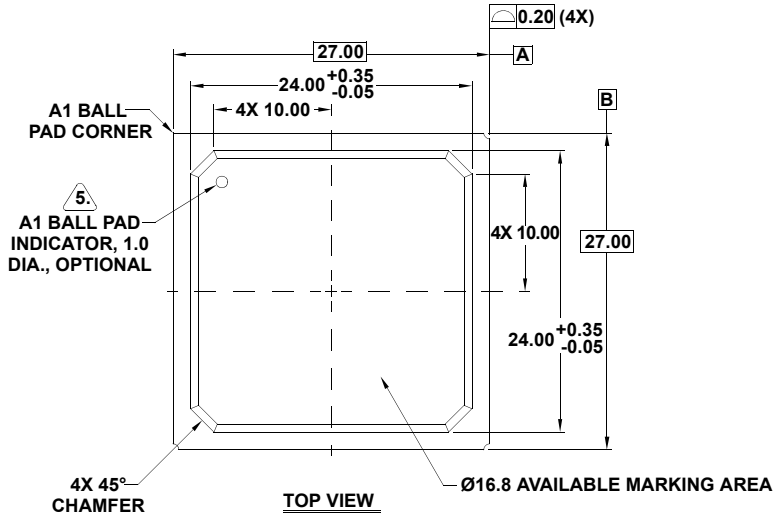

NOTES:

1. All dimensions and tolerances conform to ASME Y14.5M-1994.
2. Dimensions are in millimeters.
3. Dimension is measured at the maximum solder ball diameter, parallel to primary datum C.
4. Primary datum C and seating plane are defined by the spherical crowns of the solder balls.
5. A1 ball pad corner I.D. for plate mold: To be marked by ink. Auto mold: Dimple to be formed by mold cap.
6. Reference specifications: This drawing conforms to JEDEC registered outline MS-034/A variation BAL-2.