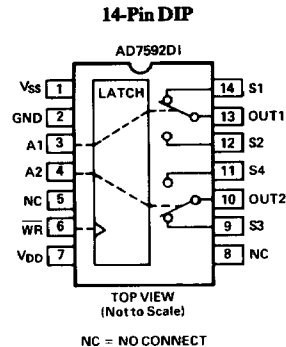
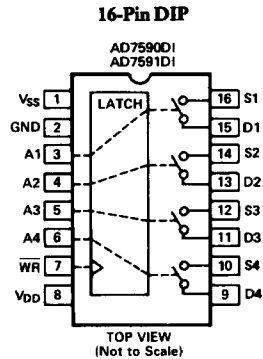

AD7590DI/AD7591DI/AD7592DI

FEATURES

- SCR Latch-Proof**
- Overvoltage-Proof: $\pm 25V$**
- Low R_{ON} : 60Ω typ**
- Buffered Switch Logic**
- TTL, CMOS Compatible**
- Monolithic Dielectrically-Isolated CMOS**
- Pin Compatible with AD7510DI Series**

FUNCTIONAL BLOCK DIAGRAMS

GENERAL DESCRIPTION

The AD7590DI, AD7591DI and AD7592DI are a family of protected (latch-proof) dielectrically isolated CMOS switches featuring overvoltage protection up to $\pm 25V$ above the power supplies. Microprocessor interfacing is facilitated by the provision of on-chip data latches.

The AD7590DI and AD7591DI consist of four independent SPST analog switches packaged in a 16-pin DIP. They differ only in that the switch control logic is inverted. The AD7592DI has two independent SPDT switches packaged in a 14-pin DIP.

CONTROL LOGIC (WR HELD LOW)

AD7590DI: Switch "ON" for Address "HIGH"

AD7591DI: Switch "ON" for Address "LOW"

AD7592DI: Address "HIGH" makes S1 to Out 1 and S3 to Out 2

AD7590DI/AD7591DI/AD7592DI—SPECIFICATIONS ($V_{DD} = 15V$, $V_{SS} = -15V$ unless otherwise noted)

Parameter	Model	$T_A = +25^\circ\text{C}$ (K, B, T)	$T_A =$ 0 to $+70^\circ\text{C}$ (K) -25°C to $+85^\circ\text{C}$ (B)	-55°C to $+125^\circ\text{C}$ (T)	Units	Test Conditions/Comments
ANALOG SWITCH						
Analog Signal Range	All	± 10	± 10	± 10	Volts	
R_{ON}^1	All	60			Ω typ	$-10V \leq V_S \leq +10V$, $I_{DS} = 1\text{mA}$;
	All	90	120	150	Ω max	Test Circuit 1
R_{ON} Match ²	All	2			Ω typ	$V_S = 0$, $I_{DS} = 1\text{mA}$
R_{ON} Match Drift ²	All	0.01			$\Omega/^\circ\text{C}$ typ	$V_S = 0$, $I_{DS} = 1\text{mA}$
I_D OFF ¹	AD7590DI	0.5			nA typ	Test Circuit 2
	AD7591DI	5	50	200	nA max	
I_S OFF ¹	All	0.5			nA typ	Test Circuits 2 & 4
		5	50	200	nA max	
I_D (I_S) ON ¹	All	0.5			nA typ	Test Circuit 3
		5	50	200	nA max	
I_{OUT}^1	AD7592DI	1			nA typ	Test Circuit 4
		10	100	400	nA max	
C_S (C_D) OFF ³	All	10			pF typ	
C_S (C_D) ON ³	All	30			pF typ	
C_{DS} (C_{S-OUT})	All	1			pF typ	
C_{DD} (C_{SS}) ³	All	0.5			pF typ	
C_{OUT}^3	AD7592DI	40			pF typ	
DIGITAL CONTROL						
V_{INL}^1	All	0.8	0.8	0.8	V max	
V_{INH}^1	All	2.4	2.4	2.4	V min	
C_{IN}^3	All	7	7	7	pF typ	
I_{INL} or $I_{INH}^{1,4}$	All	1	1	1	μA max	$V_{IN} = 0$ or V_{DD}
DYNAMIC CHARACTERISTICS						
t_{ON}^2	AD7590DI	250	380	380	ns max	Test Circuit 5
	AD7591DI	400	500	500	ns max	
t_{OFF}^2	AD7590DI	400	500	500	ns max	Test Circuit 5
	AD7591DI	250	380	380	ns max	
$t_{TRANSITION}^2$	AD7592DI	350	450	450	ns max	Test Circuit 6
Write Pulse-Width (t_{WR}) ²	All	250	300	400	ns min	See Figure 1
Address Setup Time (t_{AS}) ²	All	300	300	400	ns min	See Figure 1
Address Hold Time (t_{AH}) ²	All	20	30	40	ns min	See Figure 1
Off Isolation ³ (Analog Input to Analog Output)	All	-85			dB typ	A, $\overline{WR} = 0.8V$; $V_S = 10V$ (Pk-Pk); $f = 1\text{kHz}$, $R_L = 10k\Omega$
Crosstalk ³ (Digital Input to Analog Output)	All	5			mV peak, typ	$R_L = 1M\Omega$, $C_L = 15\text{pF}$; $V_{INH} = 3V$, $V_{INL} = 0V$; $t_{RISE} = t_{FALL} = 20\text{ns}$; \overline{WR} held HIGH
Q_{INJ}^3 (Charge Injection)	All	55			pC typ	Test Circuit 7
POWER SUPPLY						
I_{DD}^1	All	1	1.5	2	mA max	Digital Inputs = V_{INL} or V_{INH}
I_{SS}^1	All	1	1	1	mA max	

NOTES

¹100% tested.

²Guaranteed, not production tested.

³Typical values for information only, not subject to test.

⁴Inputs are MOS gates typical current less than 10nA.

Specifications subject to change without notice.

TIMING AND CONTROL SEQUENCE

Figure 1 shows the timing sequence for latching the switch address inputs. The latches are level sensitive and, therefore, while \overline{WR} is held low the latches are transparent and the switches respond to the address inputs. The digital inputs are latched on the rising edge of \overline{WR} .

NOTE: All digital input signals rise and fall times measured from 10% to 90% of 3V. $t_R = t_F = 20\text{ns}$.

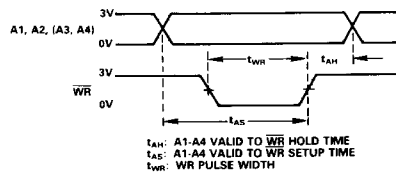

Figure 1. Timing and Control Sequence

AD7590DI/AD7591DI/AD7592DI

ABSOLUTE MAXIMUM RATINGS*

(T_A = +25°C unless otherwise noted)

V _{DD} to GND	+17V
V _{SS} to GND	-17V
Overvoltage at V _D (V _S), One Switch Only (1sec surge)	V _{DD} +25V or V _{SS} -25V
(Continuous)	V _{DD} +20V or V _{SS} -20V or 20mA, Whichever Occurs First
Switch Current (I _{DS} , Continuous)	50mA
Switch Current (I _{DS} , Surge)	
1ms Duration, 10% Duty Cycle	150mA
Digital Input Voltage Range	-0.3V to V _{DD} +0.3V
Power Dissipation (Any Package)	
Up to +75°C	450mW
Derates above +75°C by	6mW/°C
Storage Temperature	-65°C to +150°C
Operating Temperature	
Plastic (KN Versions)	0 to +70°C
Cerdip (BQ Versions)	-25°C to +85°C
Cerdip (TQ Versions)	-55°C to +125°C

*Stresses above those listed under "Absolute Maximum Ratings" may cause permanent damage to the device. This is a stress rating only, and functional operation of the device at these or any other conditions above those indicated in the operational sections of this specification is not implied. Exposure to absolute maximum rating conditions for extended periods may affect device reliability.

CAUTION:

ESD (electrostatic discharge) sensitive device. The digital control inputs are diode protected; however, permanent damage may occur on unconnected devices subject to high energy electrostatic fields. Unused devices must be stored in conductive foam or shunts. The protective foam should be discharged to the destination socket before devices are inserted.

ORDERING GUIDE

Model ¹	Temperature Range	Package Option ²
AD7590DIKN	0°C to +70°C	N-16
AD7590DIKP	0°C to +70°C	P-20A
AD7590DIBQ	-25°C to +85°C	Q-16
AD7590DITQ	-55°C to +125°C	Q-16
AD7591DIKN	0°C to +70°C	N-16
AD7591DIKP	0°C to +70°C	P-20A
AD7591DIBQ	-25°C to +85°C	Q-16
AD7591DITQ	-55°C to +125°C	Q-16
AD7592DIKN	0°C to +70°C	N-14
AD7592DIKP	0°C to +70°C	P-20A
AD7592DIBQ	-25°C to +85°C	Q-14
AD7592DITQ	-55°C to +125°C	Q-14

NOTES

¹To order MIL-STD-883C, Class B processed parts, add /883B to part number. Refer to the Analog Devices Military Products Databook (1990) for military data sheet.

²N = Narrow Plastic DIP; P = Plastic Leaded Chip Carrier Q = Cerdip. For Hermetic Surface Mount package, contact your local sales office. For outline information see Package Information section.

5

PIN CONFIGURATIONS

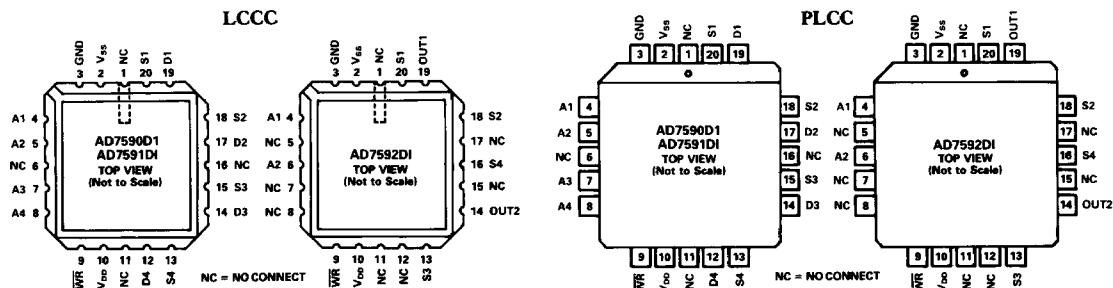
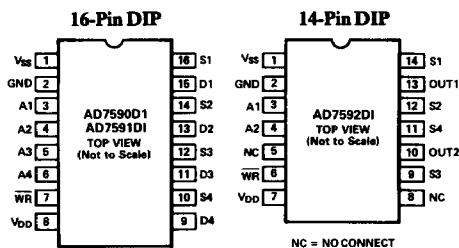

AD7590DI/AD7591DI/AD7592DI

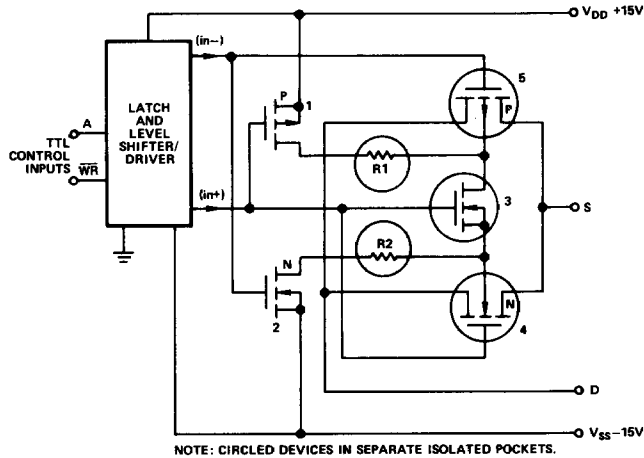

Figure 2. Typical Output Switch Circuitry of AD7590DI Series

CIRCUIT DESCRIPTION

CMOS devices make excellent analog switches; however, problems with overvoltage and latch-up phenomenon necessitated protection circuitry. These protection circuits, however, either caused degradation of important switch parameters such as R_{ON} or leakage, or provided only limited protection in the event of overvoltage.

The AD7590DI series switches utilize a dielectrically-isolated CMOS fabrication process to eliminate the four-layer substrate found in junction-isolated CMOS, thus providing latch-free operation.

A typical switch channel is shown in Figure 2. The output switching element is comprised of device numbers 4 and 5. Operation is as follows: for an "ON" switch, (in+) is V_{DD} and (in-) is V_{SS} from the driver circuits. Device numbers 1 and 2 are "OFF" and number 3 is "ON". Hence, the backgates of the P- and N-channel output devices (numbers 4 and 5) are tied together and floating. The circled devices are located in separate dielectrically isolated pockets. Floating the output switch backgates with the signal input increases the effective threshold voltage for an applied analog signal, thus providing a flatter R_{ON} versus V_S response.

For an "OFF" switch, device number 3 is "OFF," and the backgates of devices 4 and 5 are tied through $1k\Omega$ resistors (R1 and R2) to the respective supply voltages through the "ON" devices 1 and 2.

If a voltage is applied to the S or D (OUT) terminal which exceeds V_{DD} or V_{SS} , the S- or D-to-backgate diode is forward biased; however, R1 and R2 provide current limiting action to the supplies.

An equivalent circuit of the output switch element in Figure 3 shows that, indeed, the $1k\Omega$ limiting resistors are in series with the backgates of the P- and N-channel output devices – not in series with the signal path between the S and D terminals.

It is possible to turn on an "OFF" switch by applying a voltage in excess of V_{DD} or V_{SS} to the S or D terminal. If a positive stress voltage is applied to the S or D terminal which exceeds V_{DD} by a threshold, then the P-channel (device 5) will turn on creating a low impedance path between the S and D terminals. A similar situation exists for negative stress voltages which exceed V_{SS} . In this case the N-channel provides the low impedance path between the S and D terminals. The limiting factor on the overvoltage protection is the power dissipation of the package and is $\pm 20V$ continuous (or 20mA whichever occurs first) above the supply voltages.

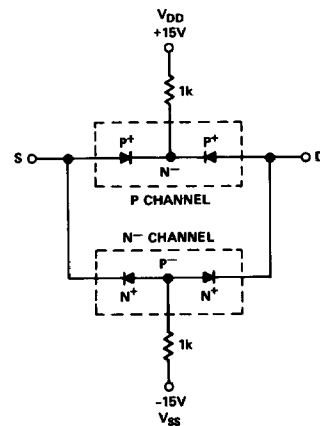
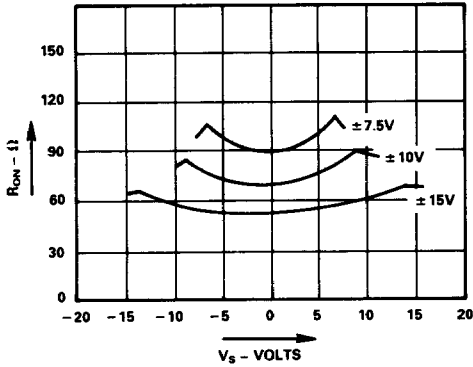
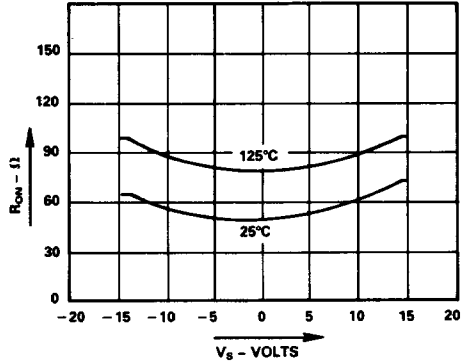

Figure 3. AD7590DI Series Output Switch Diode-Equivalent-Circuit

Typical Performance Characteristics and Test Circuits



R_{ON} AS A FUNCTION OF V_D (V_s) FOR DIFFERENT SUPPLY VOLTAGES



R_{ON} AS A FUNCTION OF V_s (V_D) FOR DIFFERENT TEMPERATURES

TEST CIRCUIT 1

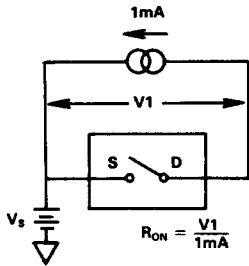

TEST CIRCUIT 2
(AD7590DI, AD7591DI)

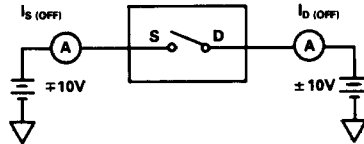

TEST CIRCUIT 3

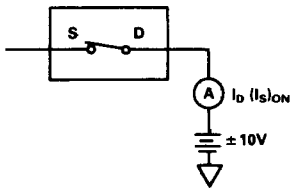

a. AD7590DI, AD7591DI

TEST CIRCUIT 4
(AD7592DI ONLY)

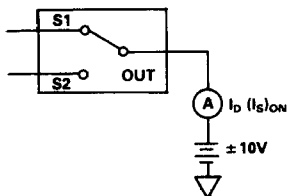
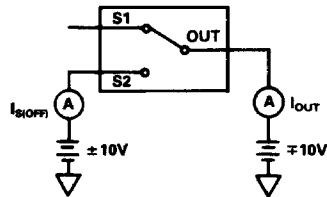

b. AD7592

AD7590DI/AD7591DI/AD7592DI

Typical Switching Characteristics and Test Circuits

Note: All digital input signal rise and fall times measured from 10% to 90% of 3V. $t_r = t_f = 20\text{ns}$.

TEST CIRCUIT 5
SWITCHING TIME OF AD7590DI AND AD7591DI, t_{ON} , t_{OFF}

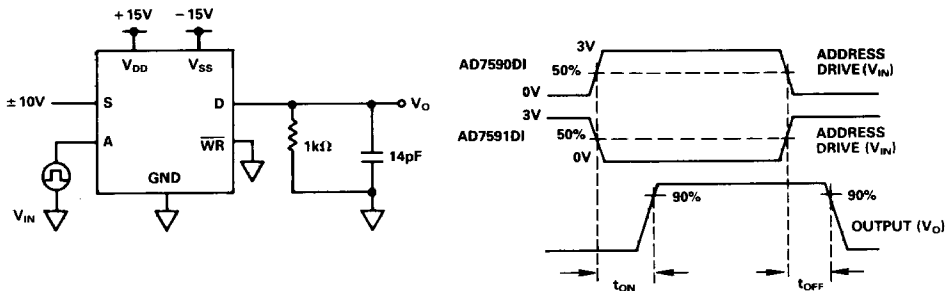

TEST CIRCUIT 6
SWITCHING TIME OF AD7592DI, $t_{TRANSITION}$

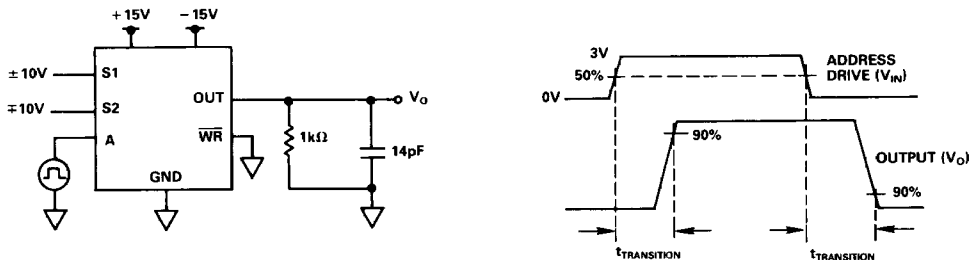

TEST CIRCUIT 7
CHARGE INJECTION

