

MAX11043

4-Channel, 16-Bit, Simultaneous-Sampling ADCs with PGA, Filter, and 8-/12-Bit Dual-Stage DAC

General Description

The MAX11043 features 4 single-ended or differential channels of simultaneous-sampling ADCs with 16-bit resolution. The MAX11043 contains a versatile filter block and programmable-gain amplifier (PGA) per channel. The filter consists of seven cascaded 2nd-order filter sections for each channel, allowing the construction of a 14th-order filter. The filter coefficients are user-programmable. Configure each 2nd-order filter as lowpass (LP), highpass (HP), or bandpass (BP) with optional rectification. Gain and phase mismatch of the analog signal path is better than -50dB.

The ADC can digitize signals up to 200kHz. A 40MHz serial interface provides communication to and from the device. The SPI interface provides throughput of 1600ksps; 4 channels at 400ksps per channel or 2 channels at 800ksps per channel. A software-selectable scan mode allows reading the ADC results while simultaneously updating the DAC. Other features of the MAX11043 include an internal (+2.5V) or external (+2.0V to +2.8V) reference, power-saving modes, and a PGA with gains of 1 to 64. The PGA includes an equalizer (EQ) function that automatically boosts low-amplitude, high-frequency signals for applications such as CW-chirp radar.

The MAX11043 includes two 8-bit coarse DACs that set the high and low references for a second-stage 12-bit fine DAC, typically used for VCO control. Use software controls to write to the DAC or step the DAC up and down under hardware control in programmable steps. The device operates from a +3.0V to +3.6V supply. The MAX11043 is available in a 40-pin, 6mm x 6mm TQFN package and operates over the extended -40°C to +125°C temperature range.

Applications

- Automotive Radar Systems
- Data Acquisition Systems
- Industrial Controls
- Power-Grid Monitoring

Features

- ◆ 4 Single-Ended or Differential Channels of Simultaneous-Sampling, 16-Bit ADCs
- ◆ ±10 LSB INL, ±1 LSB DNL, No Missing Codes
- ◆ 93dB SFDR at 100kHz Input
- ◆ PGA with Gain of 1, 2, 4, 8, 16, 32, or 64 for Each Channel
- ◆ EQ Function Automatically Boosts High-Frequency, Low-Amplitude Signals
- ◆ Seven-Stage Internal Programmable Biquad Filters per Channel
- ◆ High Throughput, 400ksps per Channel for 4 Channels
- ◆ Dual-Stage DAC
Two 8-Bit Coarse Reference DACs
12-Bit Fine DAC
- ◆ +2.5V Internal Reference or +2.0V to +2.8V External Reference
- ◆ Single +3.3V Operation
- ◆ Shutdown and Power-Saving Modes
- ◆ 40-Pin, 6mm x 6mm TQFN Package
- ◆ -40°C to +125°C Operating Temperature

Ordering Information

PART	TEMP RANGE	PIN-PACKAGE
MAX11043ATL+	-40°C to +125°C	40 TQFN-EP*
MAX11043ATL/V+	-40°C to +125°C	40 TQFN-EP*

+Denotes a lead(Pb)-free/RoHS-compliant package.

/V denotes an automotive qualified part.

*EP = Exposed pad.

Pin Configuration

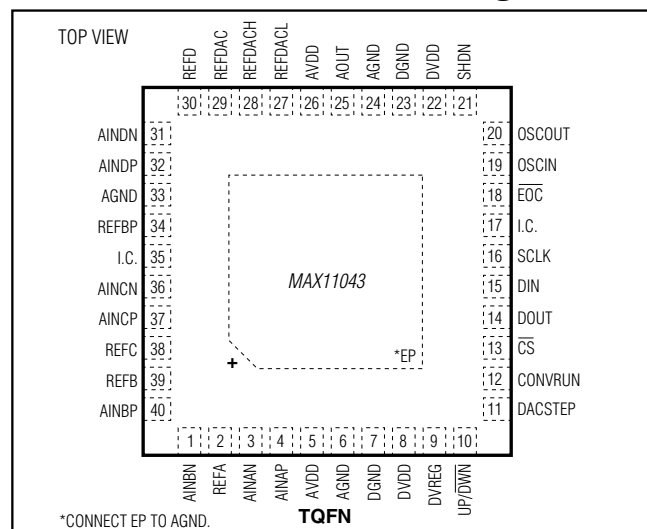

MAX11043

4-Channel, 16-Bit, Simultaneous-Sampling ADCs with PGA, Filter, and 8-/12-Bit Dual-Stage DAC

ABSOLUTE MAXIMUM RATINGS

AVDD to AGND	-0.3V to +4.0V	Continuous Power Dissipation (T _A = +70°C)
DVDD to DGND	-0.3V to +4.0V	TQFN Multilayer Board
DVREG to DGND	-0.3V to +3.0V	(derate 37mW/°C above +70°C).....
AGND to DGND	-0.3V to +0.3V	TQFN Single-Layer Board
Analog I/O, REFDAACH, REFDAACL, REFA, REFB, REFC, REFD, AOUT, REFDAAC, REFBP to AGND	-0.3V to (V _{AVDD} + 0.3V)	(derate 26.3mW/°C above +70°C).....
UP/DWN, CONVRUN, SHDN, DACSTEP, EOC, Digital I/O, OSCIN, OSCOUT to DGND	-0.3V to (V _{DVDD} + 0.3V)	Operating Temperature Range
Maximum Current into Any Pin except AVDD, DVDD, DVREG, AGND, DGND	±50mA	Junction Temperature
		Storage Temperature Range
		Lead Temperature (soldering, 10s)
		Soldering Temperature (reflow)

Stresses beyond those listed under "Absolute Maximum Ratings" may cause permanent damage to the device. These are stress ratings only, and functional operation of the device at these or any other conditions beyond those indicated in the operational sections of the specifications is not implied. Exposure to absolute maximum rating conditions for extended periods may affect device reliability.

ELECTRICAL CHARACTERISTICS

(V_{AVDD} = +3.0V to +3.6V, V_{DVDD} = +3.0V, C_{DVREG} = 10μF, V_{AGND} = V_{DGND} = 0V, common-mode input voltage = V_{AVDD}/2, V_{REFBP} = V_{REFA} = V_{REFB} = V_{REFC} = V_{REFD} = +2.5V (external reference), V_{REFDAC} = V_{REFDACH} = +1.25V (external reference), V_{REFDAACL} = 0V, C_{REFBP} = C_{REFA} = C_{REFB} = C_{REFC} = C_{REFD} = C_{REFDAC} = 1μF, f_{CLK} = 38.4MHz, f_{EXCLK} = 38.4MHz (external clock applied to OSCIN), clock divider set to 4, SHDN = DACSTEP = UP/DWN = DGND, CONVRUN = DVDD, all analog inputs driven directly through a series 150Ω/330pF anti-alias filter, PGA gain = 1. Default filters and gain settings. DIFF = 1. T_A = T_{MIN} to T_{MAX}, unless otherwise noted (Note 1). Typical values are at T_A = +25°C.)

PARAMETER	SYMBOL	CONDITIONS	MIN	TYP	MAX	UNITS
SIGMA-DELTA ADC						
Resolution	N		16			Bits
Integral Nonlinearity	INL		-16	±2		LSB
Differential Nonlinearity	DNL	Guaranteed monotonic	-1		+1	LSB
Offset Error	OE		-35		+35	mV
Offset-Error Drift				±30		μV/°C
Gain Error	GE	Trimmed with 150Ω/330pF anti-alias filter	-1		+1	%
Gain Temperature Coefficient				±50		ppm/°C
Channel Gain-Error Matching		Complete analog signal path	-0.25		+0.25	%
Channel Offset Matching		Complete analog signal path	-60		+60	mV
DYNAMIC PERFORMANCE (PGA Disabled, PGA Gain = 1 x (25kHz -1dB Full-Scale Signal))						
Maximum Full-Scale Input		ADC modulator gain = 1		1.2		V _{P-P}
Input-Referred Noise Spectral Density		100kHz		85		nV/√Hz
Second Harmonic to Fundamental			-80	-93		dB
Third Harmonic to Fundamental			-80	-110		dB
Spurious-Free Dynamic Range	SFDR		77	93		dB
Channel-to-Channel Isolation		Unused channels are shorted and unconnected	85	108		dB
Channel Phase Matching		Between all channels, including complete analog signal path		-0.05	+0.05	Degrees

MAX11043

4-Channel, 16-Bit, Simultaneous-Sampling ADCs with PGA, Filter, and 8-/12-Bit Dual-Stage DAC

ELECTRICAL CHARACTERISTICS (continued)

($V_{AVDD} = +3.0V$ to $+3.6V$, $V_{DVDD} = +3.0V$, $C_{DVREG} = 10\mu F$, $V_{AGND} = V_{DGND} = 0V$, common-mode input voltage = $V_{AVDD}/2$, $V_{REFBP} = V_{REFA} = V_{REFB} = V_{REFC} = V_{REFD} = +2.5V$ (external reference), $V_{REFDAC} = V_{REFDACH} = +1.25V$ (external reference), $V_{REFDACL} = 0V$, $C_{REFBP} = C_{REFA} = C_{REFB} = C_{REFC} = C_{REFD} = C_{REFDAC} = 1\mu F$, $f_{SCLK} = 38.4MHz$, $f_{EXCLK} = 38.4MHz$ (external clock applied to OSCIN), clock divider set to 4, SHDN = DACSTEP = UP/DWN = DGND, CONVRUN = DVDD, all analog inputs driven directly through a series $150\Omega/330pF$ anti-alias filter, PGA gain = 1. Default filters and gain settings. DIFF = 1. $T_A = T_{MIN}$ to T_{MAX} , unless otherwise noted (Note 1). Typical values are at $T_A = +25^\circ C$.)

PARAMETER	SYMBOL	CONDITIONS	MIN	TYP	MAX	UNITS
DYNAMIC PERFORMANCE (PGA Enabled, PGA Gain = 8 x (25kHz -1dB Full-Scale Signal))						
Maximum Full-Scale Input		ADC modulator gain = 1		150		mV _{P-P}
Input-Referred Noise Spectral Density		100kHz		20		nV/ \sqrt{Hz}
Second Harmonic to Fundamental				-92		dB
Third Harmonic to Fundamental				-94		dB
Spurious-Free Dynamic Range	SFDR			92		dB
Channel-to-Channel Isolation		Unused channels are shorted and unconnected		110		dB
Channel Phase Matching		Between all channels, including complete analog signal path	-0.05		+0.05	Degrees
DYNAMIC PERFORMANCE (PGA Enabled, PGA Gain = 16 x (25kHz -1dB Full-Scale Signal))						
Maximum Full-Scale Input		ADC modulator gain = 1		75		mV _{P-P}
Input-Referred Noise Spectral Density		100kHz		15		nV/ \sqrt{Hz}
Second Harmonic to Fundamental				-99		dB
Third Harmonic to Fundamental				-93		dB
Spurious-Free Dynamic Range	SFDR			93		dB
Channel-to-Channel Isolation		Unused channels are shorted and unconnected		106		dB
Channel Phase Matching		Between all channels, including complete analog signal path	-0.075		+0.075	Degrees
DYNAMIC PERFORMANCE (EQ Mode (5kHz -1dB Full-Scale Signal, CONFIG_ Register Bit 3 = 1))						
Maximum Full-Scale Input		ADC modulator gain = 1 (Note 2)		800		mV _{P-P}
Input-Referred Noise Spectral Density		100kHz		6		nV/ \sqrt{Hz}
Second Harmonic to Fundamental			-80	-90		dB
Third Harmonic to Fundamental			-77	-98		dB
Spurious-Free Dynamic Range	SFDR	Input referred (Note 3)	77	89		dB

MAX11043

4-Channel, 16-Bit, Simultaneous-Sampling ADCs with PGA, Filter, and 8-/12-Bit Dual-Stage DAC

ELECTRICAL CHARACTERISTICS (continued)

($V_{AVDD} = +3.0V$ to $+3.6V$, $V_{DVDD} = +3.0V$, $C_{DVREG} = 10\mu F$, $V_{AGND} = V_{DGND} = 0V$, common-mode input voltage = $V_{AVDD}/2$, $V_{REFBP} = V_{REFA} = V_{REFB} = V_{REFC} = V_{REFD} = +2.5V$ (external reference), $V_{REFDAC} = V_{REFDACH} = +1.25V$ (external reference), $V_{REFDACL} = 0V$, $C_{REFBP} = C_{REFA} = C_{REFB} = C_{REFC} = C_{REFD} = C_{REFDAC} = 1\mu F$, $f_{SCLK} = 38.4MHz$, $f_{EXCLK} = 38.4MHz$ (external clock applied to OSCIN), clock divider set to 4, SHDN = DACSTEP = UP/DWN = DGND, CONVRUN = DVDD, all analog inputs driven directly through a series $150\Omega/330pF$ anti-alias filter, PGA gain = 1. Default filters and gain settings. DIFF = 1. $T_A = T_{MIN}$ to T_{MAX} , unless otherwise noted (Note 1). Typical values are at $T_A = +25^\circ C$.)

PARAMETER	SYMBOL	CONDITIONS	MIN	TYP	MAX	UNITS
Channel-to-Channel Isolation		Unused channels are shorted and unconnected	80	104		dB
Channel Phase Matching		Between all channels, including complete analog signal path	-0.12		+0.12	Degrees
DYNAMIC PERFORMANCE (All Modes)						
Conversion Rate		All 4 channels			400	ksps
		2 channels only			800	
Minimum Throughput				5		ksps
Power-Supply Rejection Ratio	DCPSRR			50		dB
ANALOG INPUTS (AINAP/AINAN, AINBP/AINBN, AINCP/AINCN, AINDP/AINDN)						
Absolute Voltage Any Input		(Note 4)	0		V_{AVDD}	V
Input Impedance (Note 5)		Direct input to ADC, gain = 1	DIFF = 1	25		k Ω
			DIFF = 0	100		
		Direct input to ADC, gain = 2		7		
		Direct input to ADC, gain = 4 or 8		7		
		PGA gain = 16		5.5		
Input Capacitance		EQ mode only		50		pF
EQ FILTER (Analog and Digital)						
Unity-Gain Frequency		Default		5		kHz
Lower Transition Frequency		Default, from 40dB/decade to 0dB/decade		190		kHz
Upper Transition Frequency		Default, from 0dB/decade to -80dB/decade		205		kHz
LP FILTER						
-3dB Corner Frequency		Default		205		kHz
REFERENCE INPUT						
REF_ Input Voltage Range	$V_{REF_}$		2	2.5	2.8	V
Input Current					150	μA
REFBP Input Voltage Range	V_{REFBP}		2	2.5	2.8	V
Input Current					700	μA
REFDAC Input Voltage Range	V_{REFDAC}		1	1.25	1.4	V
Input Resistance			17			k Ω

MAX11043

4-Channel, 16-Bit, Simultaneous-Sampling ADCs with PGA, Filter, and 8-/12-Bit Dual-Stage DAC

ELECTRICAL CHARACTERISTICS (continued)

($V_{AVDD} = +3.0V$ to $+3.6V$, $V_{DVDD} = +3.0V$, $C_{DVREG} = 10\mu F$, $V_{AGND} = V_{DGND} = 0V$, common-mode input voltage = $V_{AVDD}/2$, $V_{REFBP} = V_{REFA} = V_{REFB} = V_{REFC} = V_{REFD} = +2.5V$ (external reference), $V_{REFDAC} = V_{REFDACH} = +1.25V$ (external reference), $V_{REFDACL} = 0V$, $C_{REFBP} = C_{REFA} = C_{REFB} = C_{REFC} = C_{REFD} = C_{REFDAC} = 1\mu F$, $f_{SCLK} = 38.4MHz$, $f_{EXCLK} = 38.4MHz$ (external clock applied to OSCIN), clock divider set to 4, SHDN = DACSTEP = UP/DWN = DGND, CONVRUN = DVDD, all analog inputs driven directly through a series $150\Omega/330pF$ anti-alias filter, PGA gain = 1. Default filters and gain settings. DIFF = 1. $T_A = T_{MIN}$ to T_{MAX} , unless otherwise noted (Note 1). Typical values are at $T_A = +25^\circ C$.)

PARAMETER	SYMBOL	CONDITIONS	MIN	TYP	MAX	UNITS
REFDAC_ Input Voltage Range	$V_{REFDAC_}$		0		1.4	V
Input Resistance			150			k Ω
INTERNAL REFERENCE						
Reference Voltage	V_{REFBP}		2.45	2.5	2.55	V
Reference Temperature Coefficient				100		ppm/ $^\circ C$
CRYSTAL OSCILLATOR (Max ESR 100Ω, 22pF Load Capacitors to DGND)						
Maximum Crystal Operating Frequency		Epson Electronics MA-505 (16MHz)	16			MHz
External Clock Input Frequency Range		External clock applied to OSCIN	4		40	MHz
Stability		Excluding crystal		25		ppm
Startup Time		Epson Electronics MA-505 (16MHz)		10		ms
OSCIN Input Low Voltage		When driven with external clock source			$0.3 \times V_{DVDD}$	V
OSCIN Input High Voltage		When driven with external clock source	$0.7 \times V_{DVDD}$			V
OSCIN Leakage Current			-5		+5	μA
DIGITAL INPUTS						
Input High Voltage	V_{IH}		$0.7 \times V_{DVDD}$			V
Input Low Voltage	V_{IL}				$0.3 \times V_{DVDD}$	V
Input Hysteresis				15		mV
Input Leakage Current	I_{IN}	$V_{IN} = 0V$ or V_{DVDD}	-1		+1	μA
Input Capacitance	C_{IN}			15		pF
DIGITAL OUTPUTS						
Output-Voltage High	V_{OH}	$I_{SOURCE} = 0.8mA$	$V_{DVDD} - 0.6$			V
Output-Voltage Low	V_{OL}	$I_{SINK} = 1.6mA$			0.4	V
Three-State Leakage Current		DOUT only	-1		+1	μA
Three-State Output Capacitance		DOUT only		15		pF
VOLTAGE REGULATOR						
Regulated Digital Supply Voltage	$DVREG$	Internal use only		2.5		V
POWER REQUIREMENTS						
Analog Supply Voltage			3.0		3.6	V
Digital Supply Voltage			3.0		3.6	V

MAX11043

4-Channel, 16-Bit, Simultaneous-Sampling ADCs with PGA, Filter, and 8-/12-Bit Dual-Stage DAC

ELECTRICAL CHARACTERISTICS (continued)

($V_{AVDD} = +3.0V$ to $+3.6V$, $V_{DVDD} = +3.0V$, $C_{DVREG} = 10\mu F$, $V_{AGND} = V_{DGND} = 0V$, common-mode input voltage = $V_{AVDD}/2$, $V_{REFBP} = V_{REFA} = V_{REFB} = V_{REFC} = V_{REFD} = +2.5V$ (external reference), $V_{REFDAC} = V_{REFDACH} = +1.25V$ (external reference), $V_{REFDACL} = 0V$, $C_{REFBP} = C_{REFA} = C_{REFB} = C_{REFC} = C_{REFD} = C_{REFDAC} = 1\mu F$, $f_{SCLK} = 38.4MHz$, $f_{EXCLK} = 38.4MHz$ (external clock applied to OSCIN), clock divider set to 4, SHDN = DACSTEP = UP/DWN = DGND, CONVRUN = DVDD, all analog inputs driven directly through a series $150\Omega/330pF$ anti-alias filter, PGA gain = 1. Default filters and gain settings. DIFF = 1. $T_A = T_{MIN}$ to T_{MAX} , unless otherwise noted (Note 1). Typical values are at $T_A = +25^\circ C$.)

PARAMETER	SYMBOL	CONDITIONS	MIN	TYP	MAX	UNITS
Analog Supply Current	I_{AVDD}	All channels selected	PGA disabled	60	80	mA
			PGA enabled	120	140	
Digital Supply Current	I_{DVDD}			26	40	mA
Shutdown Current	I_{AVDD}				5	mA
	I_{DVDD}				5	
STATIC ACCURACY—FINE DAC ($C_L = 200pF$, $R_L = 10k\Omega$)						
Resolution			12			Bits
Integral Nonlinearity	INL		-5		+5	LSB
Differential Nonlinearity	DNL	Guaranteed monotonic	-1		+1	LSB
Offset Error			-70		+70	mV
Offset-Error Temperature Coefficient				± 50		$\mu V/^\circ C$
Gain Error			-2		0	%
Gain-Error Temperature Coefficient				± 20		ppm of FS/ $^\circ C$
DYNAMIC PERFORMANCE—FINE DAC ($C_L = 200pF$, $R_L = 10k\Omega$)						
Output Noise		$f = 0.1Hz$ to $1MHz$		200		μV_{RMS}
DAC Glitch Impulse		Major carry transition		12		nV•s
Voltage-Output Settling Time		25% to 75% FS		3		μs
		1% FS		1.5		
Voltage-Output Slew Rate				0.6		V/ μs
STATIC ACCURACY—REFDACH AND REFDACL						
Resolution			8			Bits
Integral Nonlinearity	INL		-0.5		+0.5	LSB
Differential Nonlinearity	DNL		-0.2		+0.2	LSB
Offset Error			-30		+30	mV
Offset-Error Temperature Coefficient				± 50		$\mu V/^\circ C$
Gain Error			-5		+5	LSB
Gain-Error Temperature Coefficient					± 20	ppm of FS/ $^\circ C$
FLASH MEMORY						
Programming Endurance			10,000			Cycles
Data Retention		$T_A = +85^\circ C$	15			Years

MAX11043

4-Channel, 16-Bit, Simultaneous-Sampling ADCs with PGA, Filter, and 8-/12-Bit Dual-Stage DAC

ELECTRICAL CHARACTERISTICS (continued)

($V_{AVDD} = +3.0V$ to $+3.6V$, $V_{DVDD} = +3.0V$, $C_{DVREG} = 10\mu F$, $V_{AGND} = V_{DGND} = 0V$, common-mode input voltage = $V_{AVDD}/2$, $V_{REFBP} = V_{REFA} = V_{REFB} = V_{REFC} = V_{REFD} = +2.5V$ (external reference), $V_{REFDAC} = V_{REFDACH} = +1.25V$ (external reference), $V_{REFDACL} = 0V$, $C_{REFBP} = C_{REFA} = C_{REFB} = C_{REFC} = C_{REFD} = C_{REFDAC} = 1\mu F$, $f_{SCLK} = 38.4MHz$, $f_{EXCLK} = 38.4MHz$ (external clock applied to OSCIN), clock divider set to 4, SHDN = DACSTEP = UP/DWN = DGND, CONVRUN = DVDD, all analog inputs driven directly through a series $150\Omega/330pF$ anti-alias filter, PGA gain = 1. Default filters and gain settings. DIFF = 1. $T_A = T_{MIN}$ to T_{MAX} , unless otherwise noted (Note 1). Typical values are at $T_A = +25^\circ C$.)

PARAMETER	SYMBOL	CONDITIONS	MIN	TYP	MAX	UNITS
SPI INTERFACE						
SCLK Clock Period	t_{CP}		25			ns
SCLK Pulse-Width High	t_{CH}		10			ns
SCLK Pulse-Width Low	t_{CL}		10			ns
SCLK Rise to DOUT Transition	t_{DOT}	$C_{LOAD} = 20pF$	1		15	ns
\overline{CS} Fall to SCLK Rise Setup Time	t_{CSS}		10			ns
SCLK Rise to \overline{CS} Rise Setup Time	t_{CSH}		5			ns
DIN to SCLK Rise Setup Time	t_{DS}		10			ns
DIN to SCLK Rise Hold Time	t_{DH}		0			ns
\overline{CS} Pulse-Width High	t_{CSPWH}		10			ns
\overline{CS} Rise to DOUT Disable	t_{DOD}	$C_{LOAD} = 20pF$			20	ns
\overline{CS} Fall to DOUT Enable	t_{DOE}	$C_{LOAD} = 20pF$	1			ns
\overline{EOC} Fall to \overline{CS} Fall	t_{RDS}		10			ns

Note 1: Devices 100% production tested at $T_A = +125^\circ C$. Guaranteed by design and characterization to $T_A = -40^\circ C$.

Note 2: Full scale in analog EQ mode decreases with increasing frequency at a rate of 20dB/decade from 8kHz. If digital EQ is also used, full scale decreases with increasing frequency at 40dB/decade from 5kHz.

Note 3: SFDR in the EQ mode is normalized to the input by subtracting the analog EQ gain at each frequency (20dB/decade) from the FFT results.

Note 4: The absolute input voltage range is 0 to AVDD. For optimal performance, use a common-mode voltage of AVDD/2.

Note 5: Switched capacitor input impedance is proportional to $1/fC$. Where f is the sampling frequency and C is the input capacitance.

Typical Operating Characteristics

($V_{AVDD} = +3.3V$, $V_{DVDD} = +3.0V$, $f_{SCLK} = f_{EXCLK} = 19.2MHz$, V_{REFBP} , $V_{REF-} = +2.5V$, common-mode input voltage = $V_{AVDD}/2$, $T_A = +25^\circ C$, unless otherwise noted.)

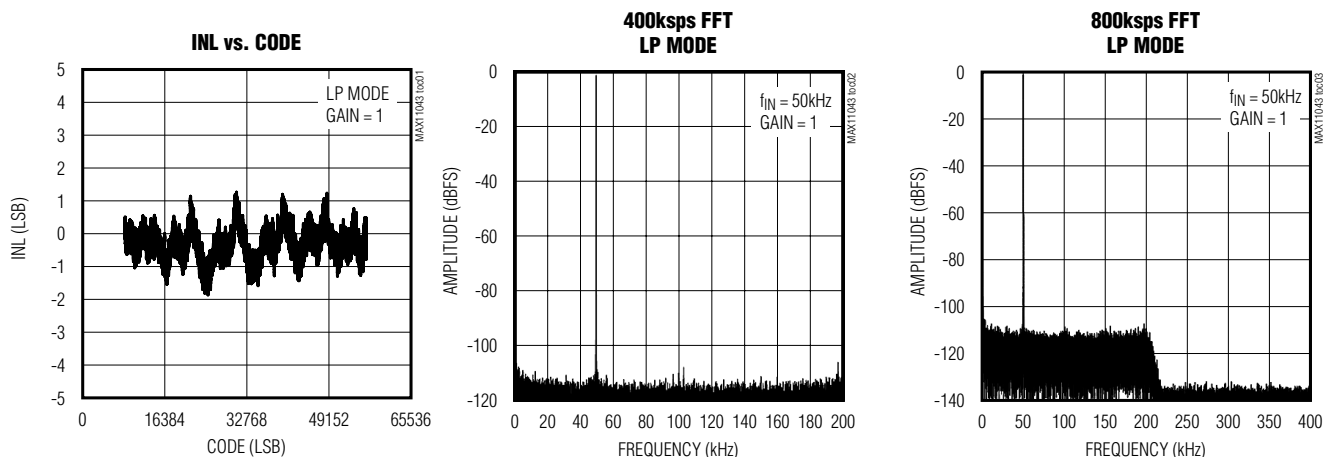

MAX11043

4-Channel, 16-Bit, Simultaneous-Sampling ADCs with PGA, Filter, and 8-/12-Bit Dual-Stage DAC

Typical Operating Characteristics (continued)

($V_{AVDD} = +3.3V$, $V_{DVDD} = +3.0V$, $f_{SCLK} = f_{EXCLK} = 19.2MHz$, V_{REFBP} , $V_{REF-} = +2.5V$, common-mode input voltage = $V_{AVDD}/2$, $T_A = +25^\circ C$, unless otherwise noted.)

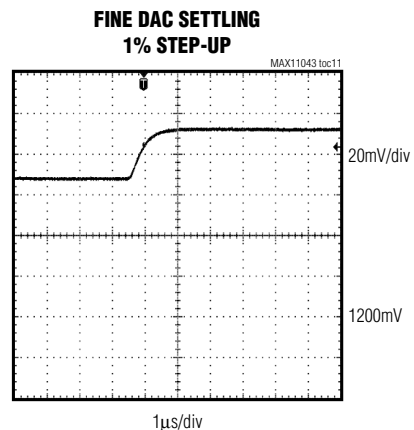
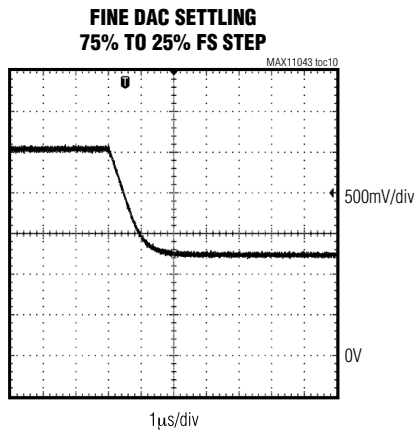
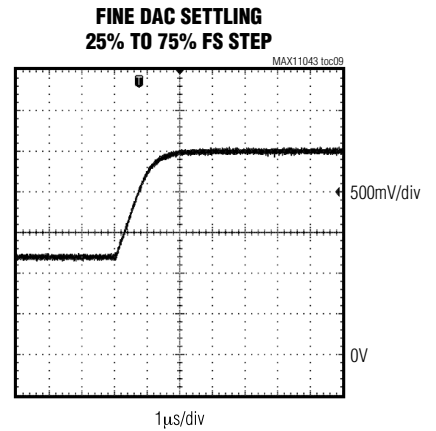
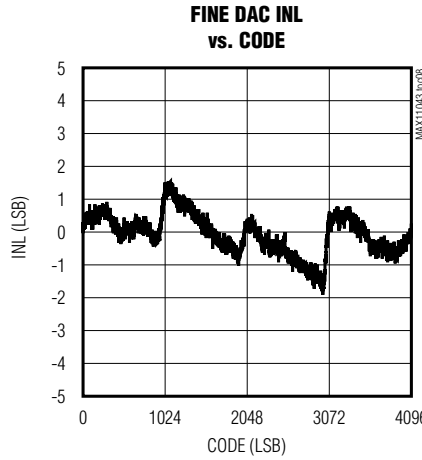
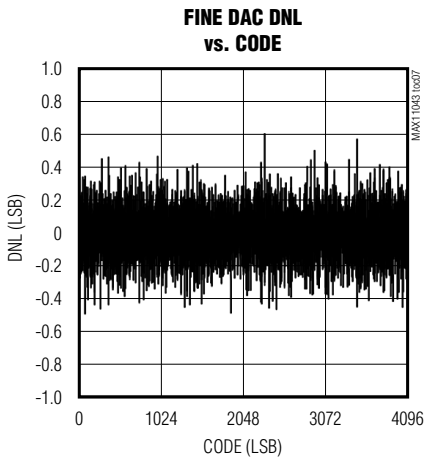
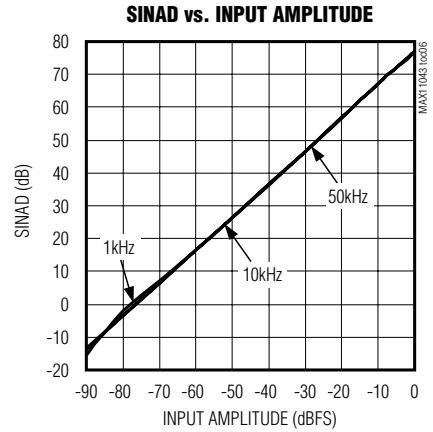
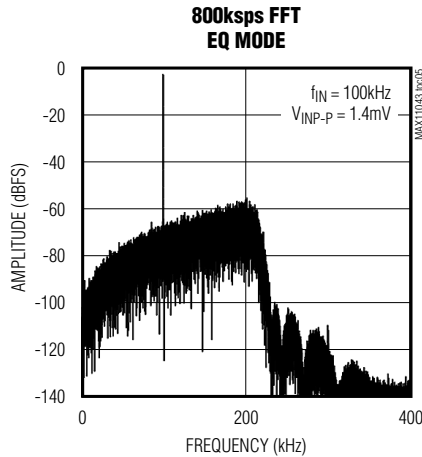
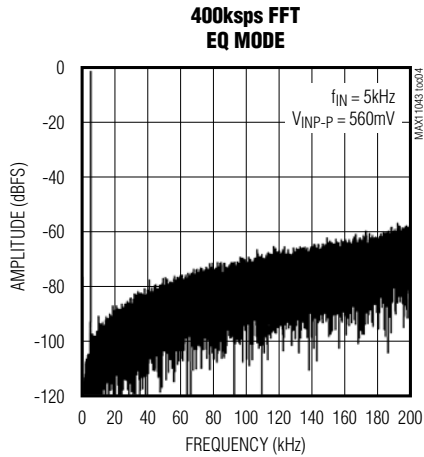

MAX11043

4-Channel, 16-Bit, Simultaneous-Sampling ADCs with PGA, Filter, and 8-/12-Bit Dual-Stage DAC

Typical Operating Characteristics (continued)

($V_{AVDD} = +3.3V$, $V_{DVDD} = +3.0V$, $f_{SCLK} = f_{EXCLK} = 19.2MHz$, V_{REFBP} , $V_{REF-} = +2.5V$, common-mode input voltage = $V_{AVDD}/2$, $T_A = +25^\circ C$, unless otherwise noted.)

**FINE DAC SETTLING
1% STEP-DOWN**

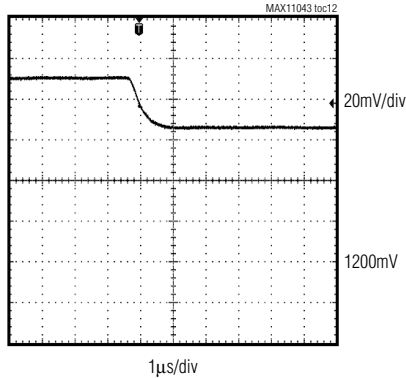

FINE DAC NOISE FLOOR

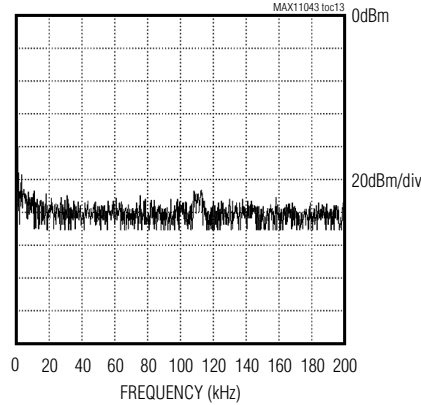

**COARSE DAC DNL
vs. CODE**

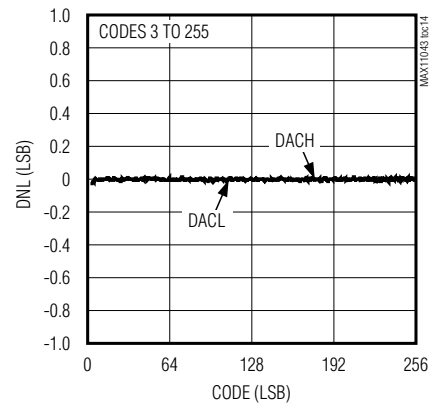

**COARSE DAC INL
vs. CODE**

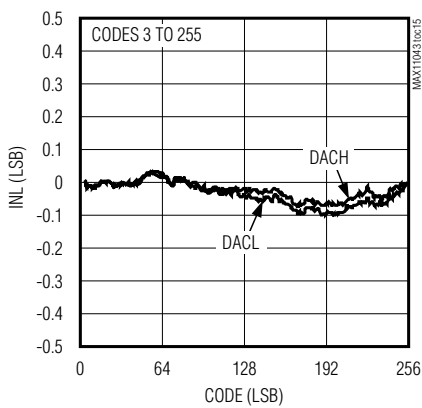

**COARSE DAC SETTLING TIME,
POSITIVE STEP**

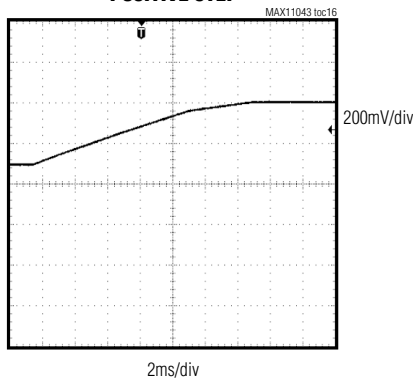

**COARSE DAC SETTLING TIME,
NEGATIVE STEP**

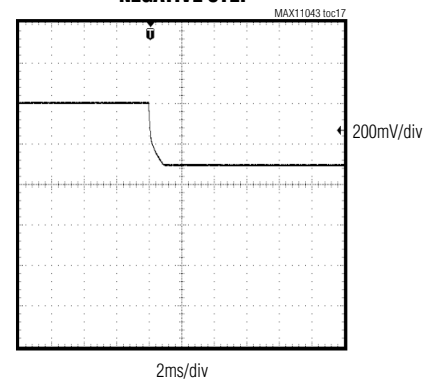

DVREG VOLTAGE vs. TEMPERATURE

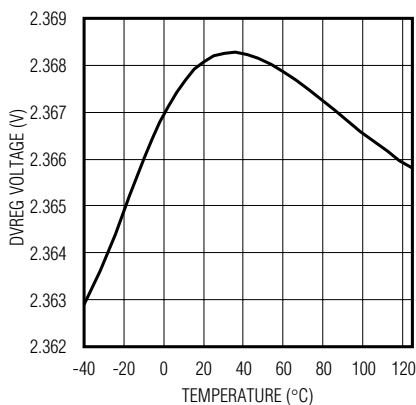

**POWER-ON RESET
vs. TEMPERATURE**

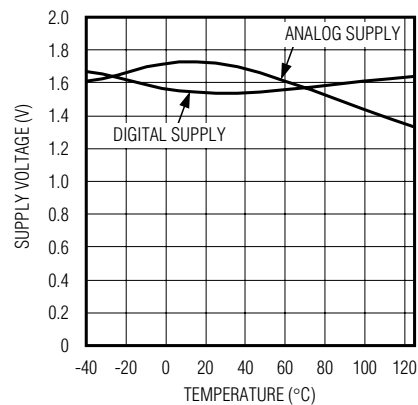

MAX11043

4-Channel, 16-Bit, Simultaneous-Sampling ADCs with PGA, Filter, and 8-/12-Bit Dual-Stage DAC

Pin Description

PIN	NAME	FUNCTION
1	AINBN	Channel B Analog Negative Input
2	REFA	Channel A Reference Bypass. Bypass REFA with a nominal 1 μ F capacitor to AGND.
3	AINAN	Channel A Analog Negative Input
4	AINAP	Channel A Analog Positive Input
5, 26	AVDD	Analog Supply. Bypass each AVDD with a nominal 1 μ F capacitor to AGND.
6, 24, 33	AGND	Analog Ground. Connect AGND inputs together.
7, 23	DGND	Digital Ground. Connect DGND inputs together.
8, 22	DVDD	Digital Supply. Bypass each DVDD with a nominal 1 μ F capacitor to DGND.
9	DVREG	Regulated Digital Core Supply. Bypass DVREG to DGND with a 10 μ F capacitor.
10	UP/DW \bar{N}	DAC Step Direction Select. Drive high to step up, drive low to step down when DACSTEP is toggled.
11	DACSTEP	DAC Step Input. Drive high to move the DAC output in the direction of UP/DW \bar{N} on the next rising edge of the system clock.
12	CONVRUN	Convert Run. Drive high to start continuous conversions on all 4 channels. The device is idle when CONVRUN is low.
13	\bar{CS}	Active-Low Serial-Interface Chip Select
14	DOUT	Serial-Interface Data Out. Data transitions on the rising edge of SCLK.
15	DIN	Serial-Interface Data In. Data is sampled on the rising edge of SCLK.
16	SCLK	Serial-Interface Clock
17, 35	I.C.	Internally Connected. Connect to either AGND or DGND.
18	\bar{EOC}	Active-Low End-of-Conversion Indicator. \bar{EOC} asserts low to indicate that new data is ready.
19	OSCIN	Crystal Oscillator/External Clock Input
20	OSCOU	Crystal-Oscillator Output. Leave unconnected when using external clock.
21	SHDN	Active-High Shutdown Input. Drive high to shut down the MAX11043.
25	AOUT	Buffered 12-Bit Fine DAC Output
27	REFDACL	Fine DAC Low Reference Bypass. Bypass REFDACL with a nominal 1 μ F capacitor to AGND.
28	REFDACH	Fine DAC High Reference Bypass. Bypass REF DACH with a nominal 1 μ F capacitor to AGND.
29	REFDAC	Coarse DAC Reference Bypass. Bypass REF DAC with a nominal 1 μ F capacitor to AGND.
30	REFD	Channel D Reference Bypass. Bypass REF D with a nominal 1 μ F capacitor to AGND.
31	AINDN	Channel D Analog Negative Input
32	AINDP	Channel D Analog Positive Input
34	REFBP	Main Reference Bypass. Bypass REF BP with a nominal 1 μ F capacitor to AGND.
36	AINCN	Channel C Analog Negative Input
37	AINCP	Channel C Analog Positive Input
38	REFC	Channel C Reference Bypass. Bypass REFC with a nominal 1 μ F capacitor to AGND.
39	REFB	Channel B Reference Bypass. Bypass REFB with a nominal 1 μ F capacitor to AGND.
40	AINBP	Channel B Analog Positive Input
—	EP	Exposed Pad. Connect EP to a ground plane on the PCB to enhance thermal dissipation. Internally connected to AGND. Not intended as an electrical connection point.

MAX11043

4-Channel, 16-Bit, Simultaneous-Sampling ADCs with PGA, Filter, and 8-/12-Bit Dual-Stage DAC

Detailed Description

The MAX11043 features 4 single-ended or differential channels of simultaneous-sampling ADCs with 16-bit resolution. The MAX11043 contains a versatile filter block and PGA per channel. The filter consists of seven cascaded 2nd-order filter sections for each channel allowing the construction of a 14th-order filter. The filter coefficients are user-programmable. Configure each 2nd-order filter as a LP filter, HP filter, or BP filter with optional rectification. Gain and phase mismatch of the analog signal path is better than -50dB.

The ADCs can digitize signals up to 200kHz. A 40MHz serial interface provides communication to and from the device. The SPI interface provides throughput of 1600ksps; 4 channels at 400ksps per channel or 2 channels at 800ksps per channel. A software-selectable scan mode allows reading the ADC results while simultaneously updating the DAC. Other features of the MAX11043 include an internal (+2.5V) or external (+2.0V to +2.8V) reference, power-saving modes, and a PGA with gains of 1 to 64. The PGA includes an EQ function that automatically boosts low-amplitude, high-frequency signals for applications such as CW-chirp radar.

The MAX11043 includes two 8-bit coarse DACs that set the high and low references for a second-stage 12-bit fine DAC, typically used for VCO control. Use software controls to set the DAC, or step the DAC up and down using hardware control in programmable steps.

MAX11043 Signal Path

Each of the 4 ADC channels features a PGA and filter block that feeds the signal to the sigma-delta modulator. The PGA can either be bypassed, which provides a gain of 1, set to a gain of 8, a gain of 16, or set to analog EQ mode. For more amplification, set the ADC modulator gain to one, two, or four. After the modulator, the result passes through the sinc 5 filter and decimator. Seven biquad programmable digital filters isolate the band of interest. Read the result using the 40MHz SPI interface. See Figure 1.

Analog-to-Digital Converter

The MAX11043 features a quad sigma-delta ADC architecture with 4 differential input channels. For single-ended operation, connect the N input to the common-mode voltage or bypass to AGND with a 10µF capacitor. All inputs feature a programmable bias generator; see the *CONFIG_ Register (0Ch-0Fh)* section. All four ADCs convert simultaneously with a maximum modulator sampling rate of 9.6Msps; decimated by 12 or 24 for output rates of 800ksps and 400ksps, respectively. The SPI bus limits the maximum output data rate to 40Mbps.

Sinc 5 Filter

The sinc 5 filter removes high-frequency noise from the output of the sigma-delta modulator and sets the upper frequency response of the ADC. It also decimates the modulator data by a factor of 12, providing a maximum of 800ksps to the programmable filters when the modulator is operating at 9.6Msps. Figure 2 shows the frequency characteristics of the sinc 5 filter with the

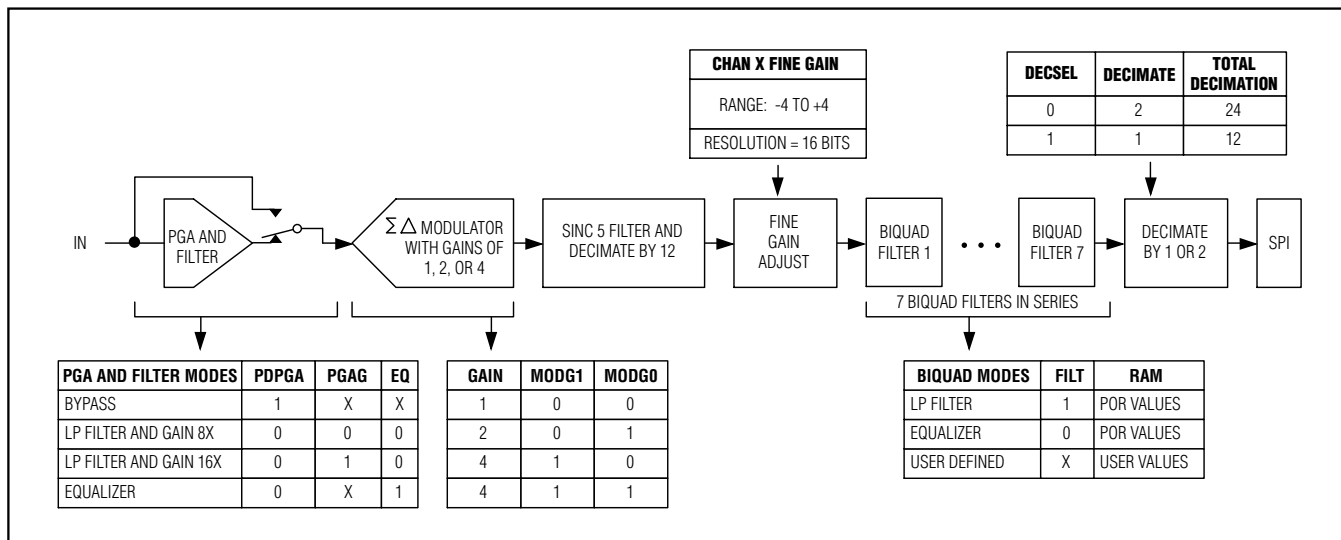

Figure 1. Signal Path

4-Channel, 16-Bit, Simultaneous-Sampling ADCs with PGA, Filter, and 8-/12-Bit Dual-Stage DAC

modulator running at 9.6Msps. Operating the modulator at a lower sample rate causes a proportional reduction in the frequency response of the sinc 5 filter. The total attenuation of the MAX11043 is the sum of the analog filtering, the sinc 5 filter, and the seven stages of programmable filters.

Equalizer (EQ)

The EQ matches the frequency/gain characteristics of CW-chirp radar systems where the distance to the target is proportional to the measured frequency. Distant targets not only have a higher frequency, they have a weaker signal. Hence, higher frequencies need more amplification than lower frequencies. The EQ provides gain proportional to frequencies up to 190kHz, at which point the gain rolls off at 80dB/decade.

The EQ consists of an analog section in the PGA and a digital EQ created from the biquad filters. The analog EQ (PGA) provides 20dB/decade of gain and the default digital EQ provides an additional 20dB/decade of gain. Together they provide 40dB/decade of gain up to 190kHz with a gain of 0dB at 5kHz.

Variations in the manufacturing process affect the gain and phase of the analog filter. Compensation for these variations include adjustments to the digital filter during the manufacture of the MAX11043. Use the analog and digital EQs together for optimal performance.

Conversion and ADC Reading

Drive CONVRUN high to initiate a continuous conversion on all 4 channels. Keep CONVRUN high for the entire conversion process. Do not pulse CONVRUN.

\overline{EOC} asserts low when new data is available. Initiate a data read prior to the next rising edge of \overline{EOC} or the result is overwritten. \overline{EOC} asserts high upon read completion of all active channels. Use ConfigA, ConfigB, ConfigC, and ConfigD registers to read single channel data. Concatenated data is available in the ADCAB, ADCCD, and ADCABCD registers. Use concatenated registers to ensure simultaneous results are read. See the *Register Functions* section for more details.

A software-selectable scan mode automatically sends the result from selected channels following the \overline{CS} falling edge and allows other registers to be simultaneously updated. To enable scan mode, set SCHAN_ bits high. See the *Configuration Register (08h)* section for a detailed description. The ADC output is presented in two's complement format (Figure 3).

Digital Filter

Seven cascaded, individually configurable, 2nd-order filter elements make up the digital filter. Figure 4 shows the structure of a single filter section. Configure these elements as LP, BP, HP, or all pass (AP) filters with optional rectification. Filter configuration is transferred from the flash to coefficient RAM (C-RAM) on power-up. Store custom filters permanently in the flash or write directly to C-RAM each time on power-up. Two separate sets of programmable coefficients exist for each filter. Dual coefficient sets allow rapid filter reconfiguration. These filter coefficients are programmed to LP and EQ modes at the factory. Multiple flash memory pages exist so that custom filters can be created while preserving factory-programmed filter coefficients.

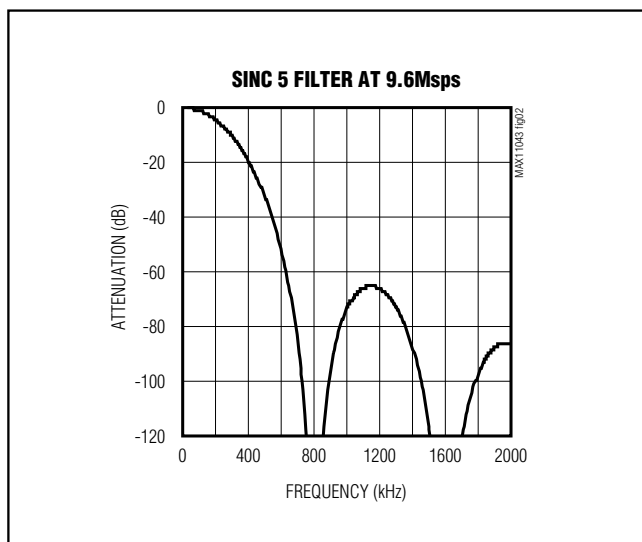

Figure 2. Sinc 5 Filter Frequency Response

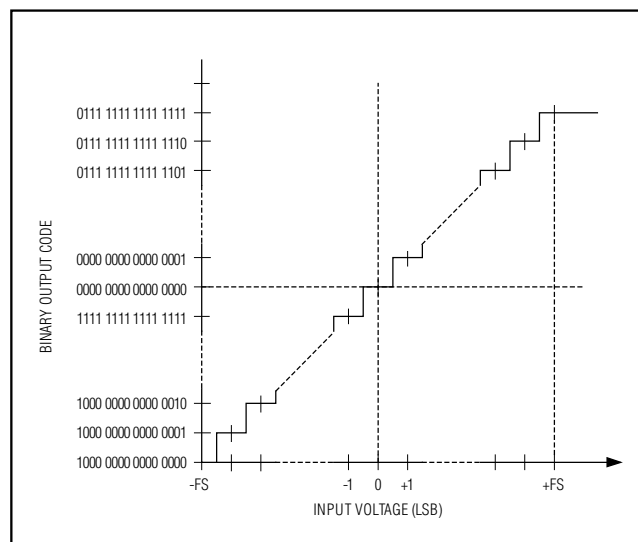

Figure 3. Two's Complement Transfer Function

MAX11043

4-Channel, 16-Bit, Simultaneous-Sampling ADCs with PGA, Filter, and 8-/12-Bit Dual-Stage DAC

Filter coefficients A1 and B1 are always 1. B3 is limited to -1, 0, and 1.

Filter coefficients A2, A3, and B2 are stored as 16-bit two's complement values in the range of -4 to +4. Filter coefficients A2 and A3 are stored as -A2 and -A3.

Gain is limited to the following values 2^4 , 2^2 , 2^0 , 2^{-2} , 2^{-4} , 2^{-6} , 2^{-8} , and 2^{-10} . For better gain resolution, adjust the

Fine Gain A/B/C/D Registers at the input of each filter set. Fine gain adjustment has a resolution of 16 bits and a gain range of -4 to +4. Set the RECT bit to rectify the filter output.

Figures 5–8 show the response to a step input of the default filters used for ADC trimming.

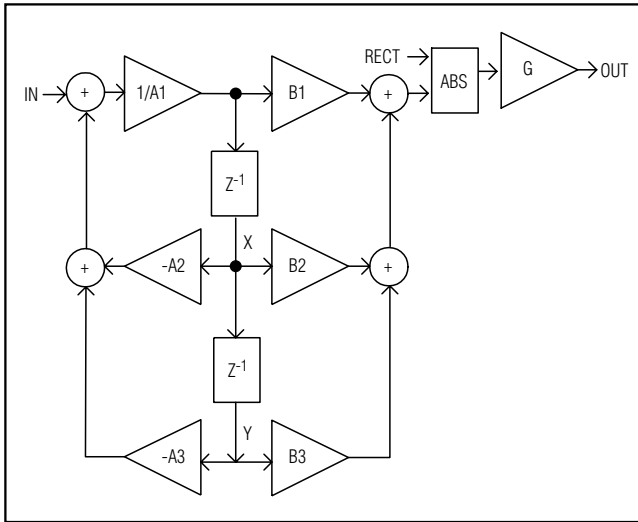

Figure 4. Single Programmable 2nd-Order Filter Section

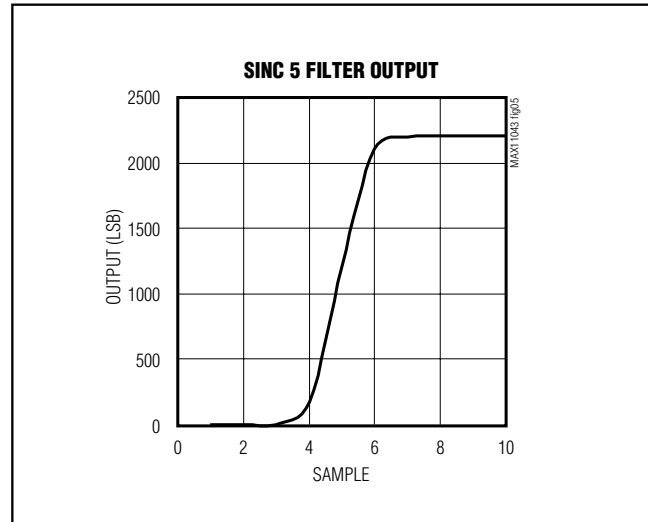

Figure 5. Sinc 5 Filter Response to a Step Input

Table 1. Default Filter Coefficients

DEFAULT LOWPASS FILTER COEFFICIENTS							
STAGE	B1	B2	B3	A1	A2	A3	GAIN
1	1	+ 2.0 (typ)	+1.0000	1	+0.468 (typ)	+0.607 (typ)	+0
2	1	+1.9509	+1.0000	1	+0.6874	+0.1317	-2
3	1	+1.6139	+1.0000	1	+0.5936	+0.2015	-2
4	1	+1.1488	+1.0000	1	+0.4395	+0.3258	+0
5	1	+0.7415	+1.0000	1	+0.2715	+0.4851	+0
6	1	+0.4651	+1.0000	1	+0.1310	+0.6685	+0
7	1	+0.3296	+1.0000	1	+0.0493	+0.8788	+0
DEFAULT EQUALIZER COEFFICIENTS							
STAGE	B1	B2	B3	A1	A2	A3	GAIN
1	1	+ 2.0 (typ)	+1.0000	1	+0.468 (typ)	+0.607 (typ)	+0
2	1	+1.9401	+1.0000	1	+0.6886	+0.1359	+0
3	1	+1.5458	+1.0000	1	+0.5803	+0.2275	-2
4	1	+1.0518	+1.0000	1	+0.4139	+0.3887	+0
5	1	+0.6785	+1.0000	1	+0.2563	+0.5966	+0
6	1	-1.0000	+0.0000	1	+0.0039	-0.0000	+4
7	1	+0.4902	+1.0000	1	+0.1649	+0.8489	+2

4-Channel, 16-Bit, Simultaneous-Sampling ADCs with PGA, Filter, and 8-/12-Bit Dual-Stage DAC

Programmable Gain Amplifier

Each ADC channel features an input buffer with input impedance of at least $5k\Omega$ and programmable gain of eight or 16. When set to a gain of one, the signal bypasses the PGA to reduce noise.

The PGA features an optional 20dB/decade analog EQ mode, with a gain of 0dB near 8kHz and attenuation above 190kHz to reduce out-of-band noise. Using the digital EQ filter adds another 20dB/decade of gain and sets the 0dB frequency to 5kHz. Control the EQ and PGA gain from their respective CONFIG_ registers. For additional filtering and equalization, use the integrated digital filters.

Digital-to-Analog Converter

The MAX11043 features a 12-bit fine DAC with high and low reference inputs set by the 8-bit, dual tap coarse DAC or driven externally. The output buffer of the fine DAC has a gain of two and can drive $10k\Omega$ and 200pF in parallel. Bypass the REF DACH and REF DACL with a $1\mu F$ capacitor when using the coarse DAC to set the reference values, or power down the buffers and drive REF DACH and REF DACL with external references. Alternatively drive one of the fine DAC references using the coarse DAC and the other using an external reference.

The fine DAC register contains the current value of the output. The output value changes by writing to this register or by the rising edge of the DACSTEP input. The DAC register updates on the next rising edge of the system clock following the rising edge of the DACSTEP input. The programmable DACSTEP register contains

the step size. The $\overline{UP/DWN}$ input sets the direction of the step. Drive $\overline{UP/DWN}$ high to step up, drive low to step down.

The coarse 8-bit, dual tap DAC generates the high and low reference values for the fine DAC. Obtain the coarse DAC reference from the main reference or by driving the REF DAC input externally. The main reference, REF BP, is divided by two before the coarse DAC. When driving REF DAC, REF DACH, or REF DACL directly, ensure the voltage to the fine DAC does not exceed $AVDD/2$ to prevent the output amplifier from saturating.

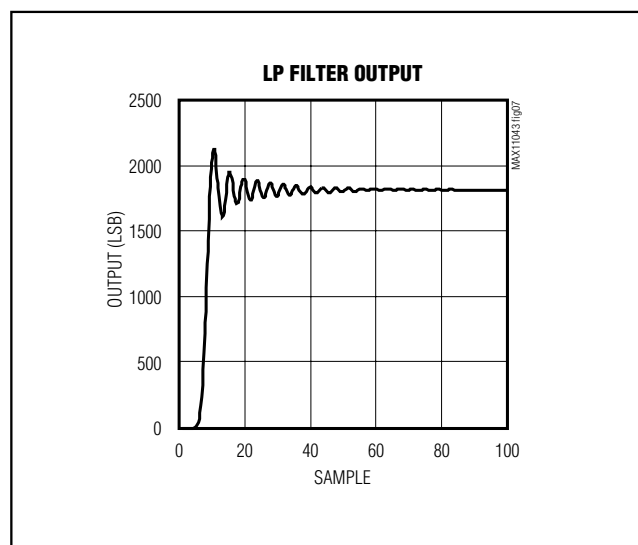

Figure 7. LP Filter Response to a Step Input

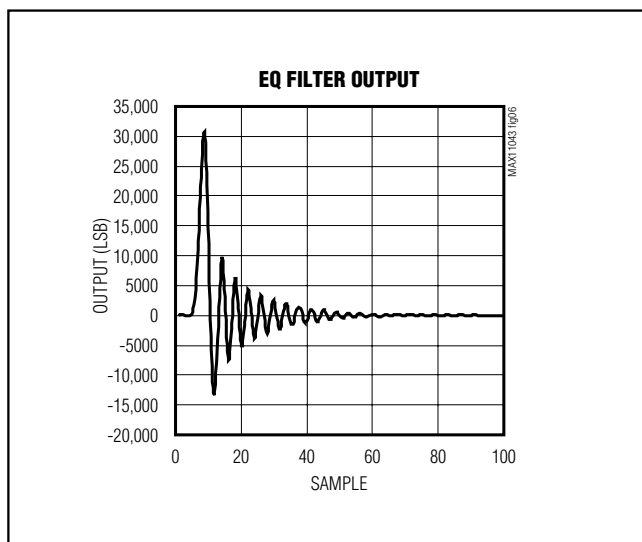

Figure 6. EQ Filter Response to a Step Input

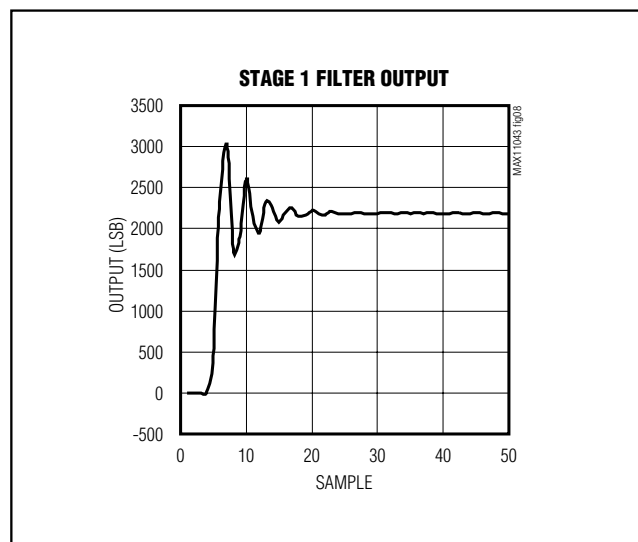

Figure 8. Stage 1 Default Filter Response to a Step Input

MAX11043

4-Channel, 16-Bit, Simultaneous-Sampling ADCs with PGA, Filter, and 8-/12-Bit Dual-Stage DAC

Reference (REFBP)

The MAX11043 features an internal 2.5V bandgap reference. Bypass REFBP with a 1 μ F capacitor or power down the buffer amplifier and drive REFBP with an external reference. In internal reference mode, REFBP provides the main reference voltage for the MAX11043.

Refer to www.maximintegrated.com/references for a list of available precision references.

In addition to the integrated main reference, there are seven separate references derived from REFBP, one for each ADC channel, one for the coarse DAC, and two (one high and one low) for the fine DAC. When using the main reference, bypass each of the references with a 1 μ F capacitor or set the appropriate bits (7–0), in the reference (10h) register, to power down the references and drive externally. Use external references capable of driving a 700 μ A or total load.

Clock Sources

The MAX11043 features an internal 16MHz oscillator that supports either an external crystal or ceramic resonator. For highest performance, set bit 15 in the configuration register to 1 and use an external clock (EX clock) source, up to 40MHz, to drive OSCIN. A programmable clock divider divides the EX clock by 2, 3, 4, or 6 to generate the ADC sample clock. The system clock, used for all digital timing, is twice the ADC sample clock. Ensure that the minimum EX clock high or low time is greater than 25ns when using the divide-by-2 or divide-by-3 mode.

The system clock, used for all internal timing, is derived from the clock divider setting and the input clock.

For optimal performance, derive the SPI clock and system clock from the same source.

Power Saving

The MAX11043 features an active-high power-down input, as well as an SPI-controlled power-down bit that places the MAX11043 in low-power mode. In addition, the MAX11043 features an independent, SPI-controlled, power-down for each ADC channel, the DAC, and the oscillator. See the *Configuration Register (08h)* section for more details.

Serial Communication

The SPI-compatible interface allows synchronous serial data transfers up to 40Mbps. The bandwidth is divided between the DACs and the ADC. Maximum conversion throughput depends on which read commands are used. The highest conversion rates are obtained by using the scan mode. The second highest rate is obtained by reading concatenated registers. The slowest method is to read the results individually.

Configure the SPI master for SCLK to idle low (SCLK is low when \overline{CS} is asserted). The data at DIN is latched on the rising edge of SCLK. Data at DOUT transitions immediately after the rising edge of SCLK.

All SPI transactions start with a command byte. The command byte selects the address of the register and the mode of operation (read/write).

SPI Command Byte

BIT 7	BIT 6	BIT 5	BIT 4	BIT 3	BIT 2	BIT 1	BIT 0
\overline{START}	ADR4	ADR3	ADR2	ADR1	ADR0	R/ \overline{W}	0

$\overline{START}<7>$: Start bit. This bit must be 0 for normal operation.

ADR<6:2>: Device register address bits. See the register map in Table 2.

R/ $\overline{W}<1>$: Read/write bit. 1 = read from device. 0 = write to device.

MAX11043

4-Channel, 16-Bit, Simultaneous-Sampling ADCs with PGA, Filter, and 8-/12-Bit Dual-Stage DAC

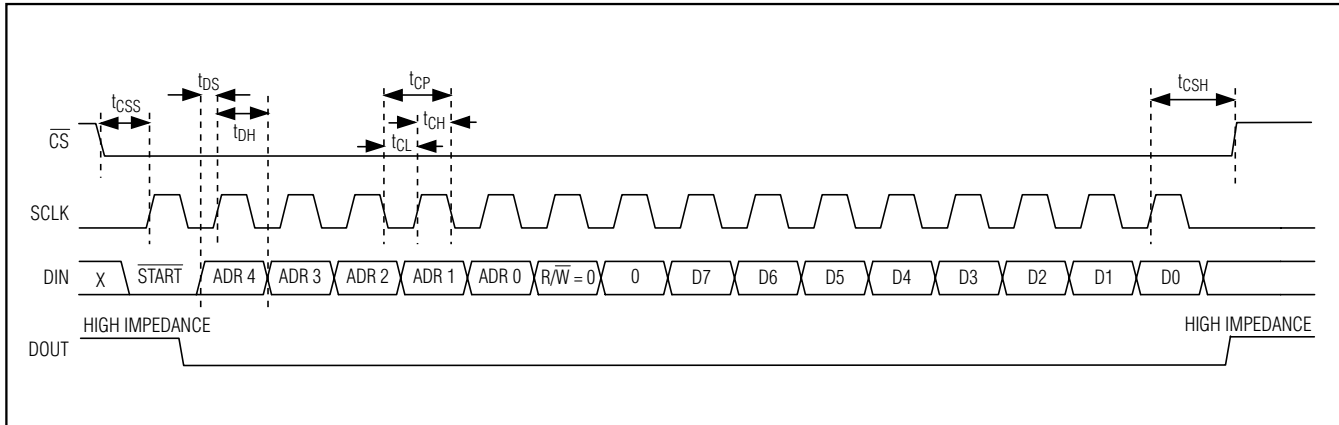

Figure 9. SPI 8-Bit Write Operation

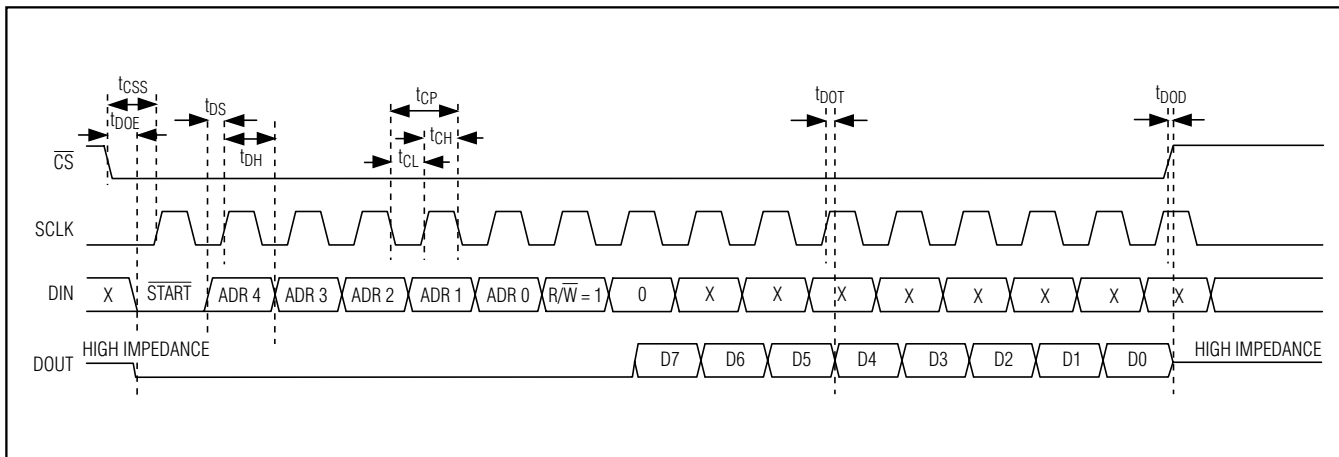

Figure 10. SPI 8-Bit Read Operation

MAX11043

4-Channel, 16-Bit, Simultaneous-Sampling ADCs with PGA, Filter, and 8-/12-Bit Dual-Stage DAC

Register Map

Table 2. SPI Register Map

ADDRESS	REGISTER NAME	FUNCTION	BITS
00h	ADCA	ADC channel A result register	16/24
01h	ADCB	ADC channel B result register	16/24
02h	ADCC	ADC channel C result register	16/24
03h	ADCD	ADC channel D result register	16/24
04h	ADCAB	ADC channels A and B results register	32/48
05h	ADCCD	ADC channels C and D results register	32/48
06h	ADCABCD	ADC channels A, B, C, and D results register	64/96
07h	Status	Status register	8
08h	Configuration	Configures the device	16
09h	DAC	Fine DAC value	16
0Ah	DACSTEP	Step size for DAC increment/decrement function	16
0Bh	DACH/DACL	High and low coarse DAC values	8 + 8
0Ch	ConfigA	ADC channel A configuration	16
0Dh	ConfigB	ADC channel B configuration	16
0Eh	ConfigC	ADC channel C configuration	16
0Fh	ConfigD	ADC channel D configuration	16
10h	Reference/Delay	Sets the operation state of the reference and buffers	16
11h	AGain	Channel A fine gain	16
12h	BGain	Channel B fine gain	16
13h	CGain	Channel C fine gain	16
14h	DGain	Channel D fine gain	16
15h	Filter coefficient address	Selects the filter coefficient to read or write. This autoincrements each time the coefficient data register is accessed.	8
16h	Filter coefficient data out	Coefficient RAMs output data	32
17h	Filter coefficient data in	Filter coefficient data	32
18h	Flash mode	Flash mode selection register	8
19h	Flash addr	Flash address register	16
1Ah	Flash data in	Flash data in register	16
1Bh	Flash data out	Flash data out register	16
1Ch	Reserved	—	—
1Dh	Reserved	—	—
1Eh	Reserved	—	—
1Fh	Reserved	—	—

MAX11043

4-Channel, 16-Bit, Simultaneous-Sampling ADCs with PGA, Filter, and 8-/12-Bit Dual-Stage DAC

Register Functions

ADCA, ADCB, ADCC, and ADCD Result Registers (00h–03h)

The ADC channel A, B, C, and D result registers provide the result data from the 4 ADC channels. \overline{EOC} asserts low when new data is available. Initiate a data read prior to the next rising edge of \overline{EOC} or the result is overwritten. Set bit 5 of the configuration register 08h high to read the data out in 24-bit resolution or set bit 5 low to read the data out in 16-bit resolution.

ADCAB, ADCCD, and ADCABCD Result Registers (04h–06h)

Registers ADCAB, ADCCD, and ADCABCD contain concatenated ADC results ensuring simultaneous results are read. This reduces the risk of reading samples delayed by one cycle from channel to channel.

Set bit 5 of the configuration register 08h high to read the data out in 24-bit resolution or set bit 5 low to read the data out in 16-bit resolution.

Status Register (07h)

BIT 7	BIT 6	BIT 5	BIT 4	BIT 3	BIT 2	BIT 1	BIT 0
X	X	Flash Busy	BOOT	OFLGA	OFLGB	OFLGC	OFLGD

The status register contains the channel overflow flags and POR bits.

X<7:6>: Don't-care bits.

Flash Busy<5>: Do not start a new flash operation until this is 0.

BOOT<4>: Power-on reset flag.

OFLG_<3:0>: Channel overflow flag, one per channel.

Configuration Register (08h)

BIT 15	BIT 14	BIT 13	BIT 12	BIT 11	BIT 10	BIT 9	BIT 8
EXTCLK	CLKDIV1	CLKDIV0	PD	PDA	PDB	PDC	PDD

BIT 7	BIT 6	BIT 5	BIT 4	BIT 3	BIT 2	BIT 1	BIT 0
PDDAC	PDOSC	24BIT	SCHANA	SCHANB	SCHANC	SCHAND	DECSEL

EXTCLK<15>: External clock select.

1 = logic-level clock supplied on OSCIN.

0 = crystal or resonator connected between OSCIN and OSCOUT (default).

CLKDIV1:CLKDIV0<14:13>: Clock divider ratio (EX clock : ADC sample clock).

00 = 1:2 clock divider.

01 = 1:3 clock divider.

10 = 1:4 clock divider.

11 = 1:6 clock divider (default).

PD<12>: Power-down analog circuitry (reference and SPI interface remains active).

1 = low-power mode.

0 = normal operation (default).

PD_<11:8>: ADC power-down for each channel (A, B, C, and D).

1 = powers down analog signal path.

0 = normal operation (default).

PDDAC< 7>: DAC power-down.

1 = fine DAC buffer powered down.

0 = normal operation (default).

PDOSC<6>: Oscillator power-down.

1 = oscillator powered down (disconnects EX clock in EX clock mode).

0 = normal operation (default).

24BIT<5>: ADC output data format.

1 = ADC data output as 24 bits.

0 = ADC data output as 16 bits (default).

Use the 24-bit ADC output in conjunction with external digital filtering to improve signal-to-noise ratio.

MAX11043

4-Channel, 16-Bit, Simultaneous-Sampling ADCs with PGA, Filter, and 8-/12-Bit Dual-Stage DAC

SCHAN_<4:1>: Automatic ADC result output for each channel (A, B, C, and D).

1 = ADC channel data is output on DOUT each time a new result is valid in the sequence, A, B, C, and D.

0 = ADC data is not presented automatically for this channel (default).

When SCHAN_ = 1, the selected ADC channel data is automatically presented on DOUT each time \overline{EOC} asserts low in the sequence A, B, C, and D with the unselected channels omitted. The data transitions on the rising edge of SCLK. Force \overline{CS} low to initiate transmission. \overline{CS} can go high between results. The MSB of the first selected ADC channel outputs immediately

after the falling edge of \overline{EOC} . \overline{EOC} goes high after the last bit of the selected channels clocks out or one clock cycle before the next result is ready. Insufficient SCLK pulses result in truncated data. Extra clock pulses give an undefined output. In scan mode, keep DIN high or write data to the MAX11043 as usual. In scan mode, the MAX11043 ignores requests for data reads.

DECSEL<0>: Decimate select.

1 = decimate by 12.

0 = decimate by 24 (default).

Set DECSEL high to decimate the ADC result by 12, doubling the number of samples. The SPI interface is limited to 40Mbps.

Fine DAC Register (09h)

BIT 15	BIT 14	BIT 13	BIT 12	BIT 11	BIT 10	BIT 9	BIT 8
X	X	X	X	DAC11	DAC10	DAC9	DAC8

BIT 7	BIT 6	BIT 5	BIT 4	BIT 3	BIT 2	BIT 1	BIT 0
DAC7	DAC6	DAC5	DAC4	DAC3	DAC2	DAC1	DAC0

X<15:12>: Don't-care bits.

DAC_<11:0>: Contains current fine DAC output value. When using the DACSTEP input to change the DAC

value, this register updates to the new value on the next rising edge of the system clock following the rising edge of DACSTEP. The power-on default is 0.

DACSTEP Register (0Ah)

BIT 15	BIT 14	BIT 13	BIT 12	BIT 11	BIT 10	BIT 9	BIT 8
X	X	X	X	DACSTEP11	DACSTEP10	DACSTEP9	DACSTEP8

BIT 7	BIT 6	BIT 5	BIT 4	BIT 3	BIT 2	BIT 1	BIT 0
DACSTEP7	DACSTEP6	DACSTEP5	DACSTEP4	DACSTEP3	DACSTEP2	DACSTEP1	DACSTEP0

X<15:12>: Don't-care bits.

DACSTEP11:DACSTEP0<11:0>: Provides the size of the DAC step. The value is positive only and the UP/DWN input is used to set the direction. The value in

the fine DAC register updates on the next rising edge of the system clock following the rising edge of the DACSTEP input. The power-on default is 0.

Coarse DACH/DACL Register (0Bh)

BIT 15	BIT 14	BIT 13	BIT 12	BIT 11	BIT 10	BIT 9	BIT 8
DACH7	DACH6	DACH5	DACH4	DACH3	DACH2	DACH1	DACH0

BIT 7	BIT 6	BIT 5	BIT 4	BIT 3	BIT 2	BIT 1	BIT 0
DACL7	DACL6	DACL5	DACL4	DACL3	DACL2	DACL1	DACL0

DACH7:DACH0<15:8>: High coarse DAC value.

DACL7:DACL0<7:0>: Low coarse DAC value.

Coarse DAC sets high and low references for the fine DAC. The power-on default is 0.

MAX11043

4-Channel, 16-Bit, Simultaneous-Sampling ADCs with PGA, Filter, and 8-/12-Bit Dual-Stage DAC

CONFIG_ Register (0Ch–0Fh)

BIT 15	BIT 14	BIT 13	BIT 12	BIT 11	BIT 10	BIT 9	BIT 8
X	X	X	BDAC3	BDAC2	BDAC1	BDAC0	DIFF

BIT 7	BIT 6	BIT 5	BIT 4	BIT 3	BIT 2	BIT 1	BIT 0
EQ	MODG1	MODG0	PDPGA	FILT	PGAG	ENBIASP	ENBIASN

This register sets the input gain of each ADC channel and selects one of the default filters or EQ function.

X<15:13>: Don't-care bits.

BDAC3:BDAC0<12:9>: Sets the input bias voltage for AC-coupled signals when ENBIAS_ is set to 1.

0000 = 33% of AVDD.

0001 = 35% of AVDD.

0010 = 38% of AVDD.

0011 = 40% of AVDD.

0100 = 42% of AVDD.

0101 = 44% of AVDD.

0110 = 46% of AVDD.

0111 = 48% of AVDD.

1000 = 50% of AVDD.

1001 = 52% of AVDD.

1010 = 54% of AVDD.

1011 = 56% of AVDD.

1100 = 58% of AVDD.

1101 = 60% of AVDD.

1110 = 62% of AVDD.

1111 = 65% of AVDD.

DIFF<8>: Input mode select bit.

1 = normal operation in all modes.

0 = use for a 2x input signal range in LP, gain = 1 mode. Note that THD degrades.

EQ<7>: EQ function.

1 = analog EQ enabled.

0 = analog EQ disabled (default).

MODG1:MODG0<6:5>: ADC modulator gain.

00 = 1 (default).

01 = 2.

10 = 4.

11 = 4.

PDPGA<4>: PGA power-down control.

1 = PGA powered down, gain = 1.

0 = PGA powered, PGA gain set by PGAG (default).

FILT<3>: Programmable filter select.

1 = use preprogrammed LP filter.

0 = use preprogrammed EQ filter (default).

PGAG<2>: High PGA gain setting.

1 = PGA, gain = 16.

0 = PGA, gain = 8 (default).

ENBIASP<1>: Positive input bias enable. Bias voltage set by BDAC3:BDAC0.

1 = selfbiasing enabled.

0 = selfbiasing disabled (default).

ENBIASN<0>: Negative input bias enable. Bias voltage set by BDAC3:BDAC0.

1 = selfbiasing enabled.

0 = selfbiasing disabled (default).

MAX11043

4-Channel, 16-Bit, Simultaneous-Sampling ADCs with PGA, Filter, and 8-/12-Bit Dual-Stage DAC

Reference Register (10h)

BIT 15	BIT 14	BIT 13	BIT 12	BIT 11	BIT 10	BIT 9	BIT 8
0	0	0	PURGE4	PURGE3	PURGE2	PURGE1	PURGE0

BIT 7	BIT 6	BIT 5	BIT 4	BIT 3	BIT 2	BIT 1	BIT 0
EXTREF	EXBUFA	EXBUFB	EXBUFC	EXBUFD	EXBUFDAC	EXBUFDACH	EXBUFDACL

Reserved<15:13>: Reserved. Set to 0.

PURGE4:PURGE0<12:8>: Filter purge interval. Straight binary.

00h = first available sample is presented (default).

1Fh = 31 results are discarded.

Digital filters retain a history of past input data. At power-up and when changing the signal path, old data requires purging before new output data is valid. PURGE4(MSB):PURGE0 determine the number of samples to discard before a new result is valid. Each time CONVRUN is taken high, N results are discarded before \overline{EOC} asserts low (where N is the decimal equivalent of the binary representation of PURGE4:PURGE0). Results prior to N+1 are overwritten. \overline{EOC} asserts for results N+1, N+2, N+3, etc., as long as CONVRUN remains high. Taking CONVRUN low and then high invokes another purge.

Purging of the sinc 5 filter requires five readings if DECSEL (configuration register 08h, bit 0) = 1 and three readings if DECSEL = 0. The minimum total purge interval of the seven cascaded filters is one reading if not used. If the filters are used, the total latency of the programmable filters is the sum of the latency caused by each stage. Set the appropriate delay for filter purging and settling time.

EXTREF<7>: Main reference selection.

1 = external reference applied to REFBP, internal reference buffer powered down.

0 = internal reference, bypass REFBP with 1 μ F to AGND (default).

EXBUF_<6:3>: ADC reference selection for each channel.

1 = external reference applied to REF_ input, internal switch open.

0 = using main internal reference, bypass REF_ with 1 μ F to AGND (default).

EXBUFDAC<2>: Coarse DAC reference selection.

1 = external reference applied to REFDAC, internal reference buffer powered down.

0 = using main internal reference, bypass REFDAC with 1 μ F to AGND (default).

EXBUFDACH<1>: High reference for fine DAC.

1 = external reference applied to REF DACH, internal reference buffer powered down.

0 = using high output from coarse DAC as reference, bypass REF DACH with 1 μ F to AGND (default).

EXBUFDACL<0>: Low reference for fine DAC.

1 = external reference applied to REF DACL, internal reference buffer powered down.

0 = using low output from coarse DAC as reference, bypass REF DACL with 1 μ F to AGND (default).

4-Channel, 16-Bit, Simultaneous-Sampling ADCs with PGA, Filter, and 8-/12-Bit Dual-Stage DAC

Fine Gain A/B/C/D Registers (11h–14h)

Fine gain for each channel is a two's complement binary value (8192 x desired gain).

FINE GAIN REGISTER	GAIN
7FFFh	(4 – 1/8192)
4000h	2
2001h	8193/8192
2000h	1 (default)
1FFFh	8191/8192
1000h	0.5
0800h	0.25

Filter Coefficient Address Register (15h)

BIT 7	BIT 6	BIT 5	BIT 4	BIT 3	BIT 2	BIT 1	BIT 0
CHAN1	CHAN0	ADR5	ADR4	ADR3	ADR2	ADR1	ADR0

CHAN_<7:6>: Channel selection.

00 = channel A (default).

01 = channel B.

10 = channel C.

11 = channel D.

ADR5:ADR0<5:0>: Address pointer for C-RAM containing filter coefficients (default = 0).

Filter Coefficient Data Out Register (16h)

This is a 32-bit register that contains the data from a C-RAM read operation.

Filter Coefficient Data In Register (17h)

This is a 32-bit register that contains the data for a C-RAM write operation. Default = 0.

MAX11043

4-Channel, 16-Bit, Simultaneous-Sampling ADCs with PGA, Filter, and 8-/12-Bit Dual-Stage DAC

Flash Mode Register (18h)

BIT 7	BIT 6	BIT 5	BIT 4	BIT 3	BIT 2	BIT 1	BIT 0
FM2 (Flashmode2)	FM1 (Flashmode1)	FM0 (Flashmode0)	0	X	X	X	Flash busy (read only)

Write allowed only if flash busy bit is zero.

FM2:FM0<7:5>: Flash operation (default 0).

000 = no operation.

001 = write data in flash data in register to flash.

010 = erase data in the selected page.

011 = mass erase the flash.

100 = no operation.

101 = read data from flash into data out register.

110 = transfer data from flash to C-RAM.

111 = no operation.

Reserved<4>: Reserved. Set to 0.

X<3:1>: Don't-care bits.

Flash busy<0>: Flash busy flag.

1 = flash busy.

0 = flash ready.

Flash Address Register (19h)

BIT 15	BIT 14	BIT 13	BIT 12	BIT 11	BIT 10	BIT 9	BIT 8
X	X	X	X	X	PAGE2	PAGE1	PAGE0

BIT 7	BIT 6	BIT 5	BIT 4	BIT 3	BIT 2	BIT 1	BIT 0
ADR7	ADR6	ADR5	ADR5	ADR3	ADR2	ADR1	ADR0

Write allowed only if flash busy bit is zero (18h bit 0 or status register) (default = 0).

X<15:11> : Don't-care bits.

PAGE2:PAGE0<10:8>: Page selection.

000 = page 0 (default).

001 = page 1.

010 = page 2.

011 = page 3.

100 = page 4.

101 = page 5.

110 = page 6.

111 = page 7.

ADR7:ADR0<7:0>: Address pointer flash word containing filter coefficients (default = 0).

4-Channel, 16-Bit, Simultaneous-Sampling ADCs with PGA, Filter, and 8-/12-Bit Dual-Stage DAC

Flash Data In Register (1Ah)

Write allowed only if flash busy bit is zero.

This is a 16-bit register that contains the data for a flash write operation. Default = 0.

Flash Data Out Register (1Bh)

This is a read-only register. Data is valid only if flash busy is zero.

This is a 16-bit register that contains the data for a flash read operation.

Flash and C-RAM Register Map

The flash memory consists of 2048 words by 16 bits. The 3 MSBs of the flash address select one of eight pages of 256 words each. Page zero contains the default filter coefficients for channels A and B. Page one contains the default filter coefficients for channels C and D. Use pages two and three for the coefficients of custom filters. When the first word on page two contains a nonzero value, the MAX11043 loads these pages into C-RAM at power-up instead of the default values from pages zero and one. Flash pages zero and one include trim data. Unique trim data optimizes the performance of each MAX11043. Coefficients for the stage 1 filters and ADC gain are individually programmed at the factory to com-

pensate for manufacturing variations in the analog portion of the IC. These coefficients vary depending on the PGA gain setting and if the analog equalizer is used. To allow for these different modes, several sets of stage 1 coefficients are stored in flash. Bits in the CONGIF register select which set of stage 1 coefficients are used. Table 3 shows the C-RAM addresses used for each CONFIG setting. To maintain optimum performance when using custom filters, copy the trim data from flash pages zero and one to the corresponding locations in flash pages two and three or to C-RAM when writing directly to C-RAM.

For custom filters, use stages 2–7 first, and only change the stage 1 coefficients when all seven stages require customization.

To load the coefficients directly to C-RAM, create a 32-bit data word by concatenating the data in adjacent flash locations as shown in Table 3. The C-RAM addresses below are for channel A; for channel B add 40h, for channel C add 80h, and for channel D add C0h.

Multiple addresses exist for some stage 1 filter coefficients as shown in Table 4. The address accessed by the filter depends on the configuration bits as shown in Table 3.

Table 3. Stage 1 Filter Selection

STAGE 1 COEFFICIENT ADDRESS	EQ	PDPGA	MODG	PGAG
EQ filter stage 1 (C-RAM address 03h–05h)	1	0	XX	X
LP filter for ADC gain of 1, 2, and 4; stage 1 (C-RAM address 1Dh–1Fh)	X	1	XX	X
LP filter for ADC gain of 8; stage 1 (C-RAM address 3Dh–3Fh)	0	0	00	0
LP filter for ADC gain of 16; stage 1 (C-RAM address 23h–25h)	0	0	XX	1

Table 4. C-RAM and Flash Memory Map for Channel A Flash Page One*

C-RAM ADDRESS	FLASH ADDRESS	MSB FOR C-RAM	LSB FOR C-RAM
00h	00h	—	Not used
	01h*	EQ gain trim for gain = 1	—
01h	02h	—	Not used
	03h	User trim for EQ gain, default = 2000h	—
02h	04h	—	Not used
	05h	Not used	—
03h	06h*	—	EQ filter gain for filter stage 1
	07h*	EQ filter coefficient -A2 for filter stage 1	—

*For channel B add 80h, for channel C add 100h, and for channel D add 180h. To write to pages two and three of flash, add 200h to these values.

MAX11043

4-Channel, 16-Bit, Simultaneous-Sampling ADCs with PGA, Filter, and 8-/12-Bit Dual-Stage DAC

Table 4. C-RAM and Flash Memory Map (continued)

C-RAM ADDRESS	FLASH ADDRESS	MSB FOR C-RAM	LSB FOR C-RAM
04h	08h	—	Not used
	09h*	EQ filter coefficient -A3 for filter stage 1	—
05h	0Ah*	—	EQ filter coefficient B3 and rectify bit for filter stage 1
	0Bh*	EQ filter coefficient B2 for filter stage 1	—
06h	0Ch	—	EQ filter gain for filter stage 2
	0Dh	EQ filter coefficient -A2 for filter stage 2	—
07h	0Eh	—	Not used
	0Fh	EQ filter coefficient -A3 for filter stage 2	—
08h	10h	—	EQ filter coefficient B3 and rectify bit for filter stage 2
	11h	EQ filter coefficient B2 for filter stage 2	—
09h	12h	—	EQ filter gain for filter stage 3
	13h	EQ filter coefficient -A2 for filter stage 3	—
0Ah	14h	—	Not used
	15h	EQ filter coefficient -A3 for filter stage 3	—
0Bh	16h	—	EQ filter coefficient B3 and rectify bit for filter stage 3
	17h	EQ filter coefficient B2 for filter stage 3	—
0Ch	18h	—	EQ filter gain for filter stage 4
	19h	EQ filter coefficient -A2 for filter stage 4	—
0Dh	1Ah	—	Not used
	1Bh	EQ filter coefficient -A3 for filter stage 4	—
0Eh	1Ch	—	EQ filter coefficient B3 and rectify bit for filter stage 4
	1Dh	EQ filter coefficient B2 for filter stage 4	—
0Fh	1Eh	—	EQ filter gain for filter stage 5
	1Fh	EQ filter coefficient -A2 for filter stage 5	—
10h	20h	—	Not used
	21h	EQ filter coefficient -A3 for filter stage 5	—
11h	22h	—	EQ filter coefficient B3 and rectify bit for filter stage 5
	23h	EQ filter coefficient B2 for filter stage 5	—
12h	24h	—	EQ filter gain for filter stage 6
	25h	EQ filter coefficient -A2 for filter stage 6	—
13h	26h	—	Not used
	27h	EQ filter coefficient -A3 for filter stage 6	—
14h	28h	—	EQ filter coefficient B3 and rectify bit for filter stage 6
	29h	EQ filter coefficient B2 for filter stage 6	—
15h	2Ah	—	EQ filter gain for filter stage 7
	2Bh	EQ filter coefficient -A2 for filter stage 7	—
16h	2Ch	—	Not used
	2Dh	EQ filter coefficient -A3 for filter stage 7	—

4-Channel, 16-Bit, Simultaneous-Sampling ADCs with PGA, Filter, and 8-/12-Bit Dual-Stage DAC

Table 4. C-RAM and Flash Memory Map (continued)

C-RAM ADDRESS	FLASH ADDRESS	MSB FOR C-RAM	LSB FOR C-RAM
17h	2Eh	—	EQ filter coefficient B3 and rectify bit for filter stage 7
	2Fh	EQ filter coefficient B2 for filter stage 7	—
18h	30h	—	Not used
	31h*	ADC gain trim for gain = 1	—
19h	32h	—	Not used
	33h*	ADC gain trim for gain = 2	—
1Ah	34h	—	Not used
	35h*	ADC gain trim for gain = 4	—
1Bh	36h	—	Not used
	37h*	EQ gain trim for gain = 2	—
1Ch	38h	—	Not used
	39h*	EQ gain trim for gain = 4	—
1Dh	3Ah*	—	LP filter gain for filter stage 1, gain = 1, 2, or 4
	3Bh*	LP filter coefficient -A2 for filter stage 1, gain = 1, 2, or 4	—
1Eh	3Ch	—	Not used
	3Dh*	LP filter coefficient -A3 for filter stage 1, gain = 1, 2, or 4	—
1Fh	3Eh*	—	LP filter coefficient B3 and rectify bit for filter stage 1, gain = 1, 2, or 4
	3Fh*	LP filter coefficient B2 for filter stage 1, gain = 1, 2, or 4	—
20h	40h	—	Not used
	41h*	ADC gain trim for gain = 16	—
21h	42h	—	Not used
	43h	User trim for ADC gain, default = 2000h	—
22h	44h	—	Not used
	45h	Not used	—
23h	46h*	—	LP filter gain for filter stage 1, gain = 16
	47h*	LP filter coefficient -A2 for filter stage 1, gain = 16	—
24h	48h	—	Not used
	49h*	LP filter coefficient -A3 for filter stage 1, gain = 16	—
25h	4Ah*	—	LP filter coefficient B3 and rectify bit for filter stage 1, gain = 16
	4Bh*	LP filter coefficient B2 for filter stage 1, gain = 16	—
26h	4Ch	—	LP filter gain for filter stage 2
	4Dh	LP filter coefficient -A2 for filter stage 2	—

MAX11043

4-Channel, 16-Bit, Simultaneous-Sampling ADCs with PGA, Filter, and 8-/12-Bit Dual-Stage DAC

Table 4. C-RAM and Flash Memory Map (continued)

C-RAM ADDRESS	FLASH ADDRESS	MSB FOR C-RAM	LSB FOR C-RAM
27h	4Eh	—	Not used
	4Fh	LP filter coefficient -A3 for filter stage 2	—
28h	50h	—	LP filter coefficient B3 and rectify bit for filter stage 2
	51h	LP filter coefficient B2 for filter stage 2	—
29h	52h	—	LP filter gain for filter stage 3
	53h	LP filter coefficient -A2 for filter stage 3	—
2Ah	54h	—	Not used
	55h	LP filter coefficient -A3 for filter stage 3	—
2Bh	56h	—	LP filter coefficient B3 and rectify bit for filter stage 3
	57h	LP filter coefficient B2 for filter stage 3	—
2Ch	58h	—	LP filter gain for filter stage 4
	59h	LP filter coefficient -A2 for filter stage 4	—
2Dh	5Ah	—	Not used
	5Bh	LP filter coefficient -A3 for filter stage 4	—
2Eh	5Ch	—	LP filter coefficient B3 and rectify bit for filter stage 4
	5Dh	LP filter coefficient B2 for filter stage 4	—
2Fh	5Eh	—	LP filter gain for filter stage 5
	5Fh	LP filter coefficient -A2 for filter stage 5	—
30h	60h	—	Not used
	61h	LP filter coefficient -A3 for filter stage 5	—
31h	62h	—	LP filter coefficient B3 and rectify bit for filter stage 5
	63h	LP filter coefficient B2 for filter stage 5	—
32h	64h	—	LP filter gain for filter stage 6
	65h	LP filter coefficient -A2 for filter stage 6	—
33h	66h	—	Not used
	67h	LP filter coefficient -A3 for filter stage 6	—
34h	68h	—	LP filter coefficient B3 and rectify bit for filter stage 6
	69h	LP filter coefficient B2 for filter stage 6	—
35h	6Ah	—	LP filter gain for filter stage 7
	6Bh	LP filter coefficient -A2 for filter stage 7	—
36h	6Ch	—	Not used
	6Dh	LP filter coefficient -A3 for filter stage 7	—
37h	6Eh	—	LP filter coefficient B3 and rectify bit for filter stage 7
	6Fh	LP filter coefficient B2 for filter stage 7	—
38h	70h	—	Not used
	71h	Not used	—
39h	72h	—	Not used
	73h	Not used	—
3Ah	74h	—	Not used
	75h*	ADC gain trim for gain = 8	—

4-Channel, 16-Bit, Simultaneous-Sampling ADCs with PGA, Filter, and 8-/12-Bit Dual-Stage DAC

Table 4. C-RAM and Flash Memory Map (continued)

C-RAM ADDRESS	FLASH ADDRESS	MSB FOR C-RAM	LSB FOR C-RAM
3Bh	76h	—	Not used
	77h*	ADC gain trim for gain = 32	—
3Ch	78h	—	Not used
	79h*	ADC gain trim for gain = 64	—
3Dh	7Ah*	—	LP filter gain for filter stage 1, gain = 8
	7Bh*	LP filter coefficient -A2 for filter stage 1, gain = 8	—
3Eh	7Ch	—	Not used
	7Dh*	LP filter coefficient -A3 for filter stage 1, gain = 8	—
3Fh	7Eh*	—	LP filter coefficient B3 and rectify bit for filter stage 1, gain = 8
	7Fh*	LP filter coefficient B2 for filter stage 1, gain = 8	—

*Recommended copy to C-RAM or flash for optimum custom-filter performance.

Flash Erase and Programming

When erasing or programming the flash, maintain the system clock between 14MHz and 27MHz to satisfy flash timing requirements and ensure CONVRUN = 0. The system clock used for all digital timing is twice the ADC sample clock (2 x EX clock/divider).

Always erase the flash page before writing new data.

The procedure for flash mass erase is as follows:

- 1) Read the flash mode register (18h); proceed when the LSB is zero.
- 2) Write 0000h to the flash address register (19h).
- 3) Write 60h to the flash mode register (18h).
- 4) Wait 200ms for erase to complete.
- 5) FFFFh = flash erased state.

The procedure for flash single page erase is as follows:

- 1) Read the flash mode register (18h); proceed when the LSB is zero.
- 2) Write page address, set word address to 00h in the flash address register (19h).
- 3) Write 40h to the flash mode register (18h).
- 4) Wait 20ms for page erase to complete.
- 5) FFFFh = flash erased state.

The procedure for flash single word write is as follows:

- 1) Read the flash mode register (18h); proceed when the LSB is zero.

- 2) Write page and word address to the flash address register (19h).

- 3) Write the data to the flash data in register (1Ah).

- 4) Write 20h to the flash mode register (18h).

- 5) Read the flash mode register (18h); proceed when the LSB is zero (approx. 40µs).

The procedure for flash single word read is as follows:

- 1) Read the flash mode register (18h); proceed when the LSB is zero.

- 2) Write page and word address to the flash address register (19h).

- 3) Write A0h to the flash mode register (18h).

- 4) Read the flash mode register (18h); proceed when the LSB is zero (approx. 1µs).

- 5) Read the data from the flash data out register (1Bh).

The procedure for flash to C-RAM transfer is as follows:

- 1) Read the flash mode register (18h); proceed when the LSB is zero.

- 2) Write C0h to the flash mode register (18h).

- 3) Read the flash mode register (18h); proceed when the LSB is zero (approx. 1ms).

- 4) The content of flash is transferred to C-RAM.

MAX11043

4-Channel, 16-Bit, Simultaneous-Sampling ADCs with PGA, Filter, and 8-/12-Bit Dual-Stage DAC

Digital Filter Coefficients

Table 5. Typical Filter Coefficients Register Map (LP Filter Channel A, Stage 3)

COEFFICIENT FLASH ADDRESS	FUNCTION
52h	Gain for channel A, stage 3
53h	A2 coefficient for channel A, stage 3
54h	Not used; set to 0
55h	A3 coefficient for channel A, stage 3
56h	B3 coefficient and rectify flag (RECT) for channel A, stage 3
57h	B2 coefficient for channel A, stage 3

Format for Filter Stage Gain (52h)

BIT 15	BIT 14	BIT 13	BIT 12	BIT 11	BIT 10	BIT 9	BIT 8
X	GAIN2	GAIN1	GAIN0	X	X	X	X

BIT 7	BIT 6	BIT 5	BIT 4	BIT 3	BIT 2	BIT 1	BIT 0
X	X	X	X	X	X	X	X

X<15>: Don't-care bit. Not used.

GAIN2:GAIN0<14:12>: Filter gain.

000 = $2^4 = 16$.

001 = $2^2 = 4$.

010 = $2^0 = 1$.

011 = $2^{-2} = 0.25$.

100 = $2^{-4} = 0.0625$.

101 = $2^{-6} = 0.015625$.

110 = $2^{-8} = 0.00390625$.

111 = $2^{-10} = 0.0009765625$.

X<11:0>: Don't-care bits. Not used.

MAX11043

4-Channel, 16-Bit, Simultaneous-Sampling ADCs with PGA, Filter, and 8-/12-Bit Dual-Stage DAC

A2, A3, and B2 Filter Coefficient Format (52h, 54h, 56h)

Filter coefficients A2, A3, and B2 are stored as 16-bit two's complement values in the -4 to $(4 - 2^{-13})$ range.

The transfer function equation is as follows:

$$A2 = \text{int}(N \times 2^{13})$$

where N is the decimal coefficient value.

The following are two examples of the transfer function equation:

Example 1:

$$N = 2.381$$

$$A2 = \text{int}(2.381 \times 2^{13})$$

$$A2 = \text{int}(19505.152)$$

$$A2 = 19505 = 4C31\text{h (two's complement)}$$

Example 2:

$$N = -2.381$$

$$A2 = \text{int}(-2.381 \times 2^{13})$$

$$A2 = \text{int}(-19505.152)$$

$$A2 = -19505 = B3CF\text{h (two's complement)}$$

B3 Coefficient (56h)

BIT 15	BIT 14	BIT 13	BIT 12	BIT 11	BIT 10	BIT 9	BIT 8
B31	B30	RECT	X	X	X	X	X

BIT 7	BIT 6	BIT 5	BIT 4	BIT 3	BIT 2	BIT 1	BIT 0
X	X	X	X	X	X	X	X

B31:B30<15:14>: Filter coefficient B3.

11 = -1.

00 = 0.

01 = 1.

10 = 0.

X<13>: Don't-care bit. Not used.

RECT<12>: Rectify bit.

0 = bipolar output.

1 = output rectified. All samples positive.

X<11:0>: Don't-care bits. Not used.

Power Supplies, Layout, and Bypassing Considerations

For best performance, use PCBs with ground planes. Ensure that digital and analog signal lines are separated from each other. Do not run analog and digital lines parallel to one another (especially clock lines), and do not run digital lines underneath the MAX11043 package. Use a single-point analog ground (star ground

point) at AGND, separate from the logic ground. Connect all other analog grounds and DGND to this star ground point. Do not connect other digital system grounds to this single-point analog ground. The ground return to the power supply for this ground should be low impedance and as short as possible for noise-free operation. Bypass all supplies to ground with high quality capacitors as close as possible to the device.

MAX11043

4-Channel, 16-Bit, Simultaneous-Sampling ADCs with PGA, Filter, and 8-/12-Bit Dual-Stage DAC

Typical Operating Circuit

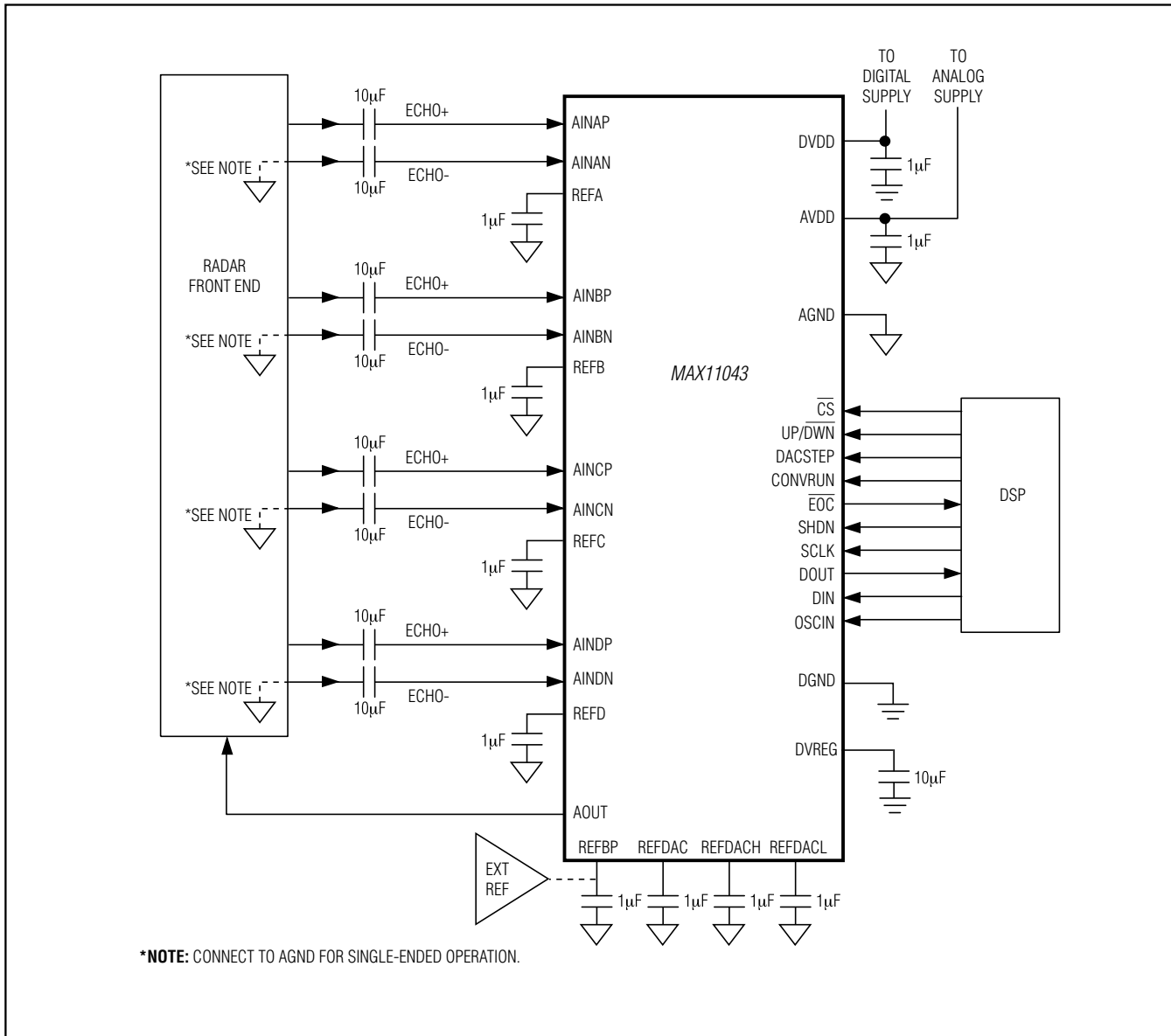

Chip Information

PROCESS: BiCMOS

Package Information

For the latest package outline information and land patterns (footprints), go to www.maximintegrated.com/packages. Note that a "+", "#", or "-" in the package code indicates RoHS status only. Package drawings may show a different suffix character, but the drawing pertains to the package regardless of RoHS status.

PACKAGE TYPE	PACKAGE CODE	OUTLINE NO.	LAND PATTERN NO.
40 TQFN-EP	T4066+5	21-0141	90-0055

MAX11043

4-Channel, 16-Bit, Simultaneous-Sampling ADCs with PGA, Filter, and 8-/12-Bit Dual-Stage DAC

Revision History

REVISION NUMBER	REVISION DATE	DESCRIPTION	PAGES CHANGED
0	8/08	Initial release	—
1	3/10	Updated <i>Ordering Information</i> with automotive grade information and clarified/amended data sheet	1, 2-7, 12-15, 21, 25, 30
2	3/11	Updated the <i>Flash Erase and Programming</i> section	29
3	11/12	Released the MAX11043ATL/V+	1



Maxim Integrated cannot assume responsibility for use of any circuitry other than circuitry entirely embodied in a Maxim Integrated product. No circuit patent licenses are implied. Maxim Integrated reserves the right to change the circuitry and specifications without notice at any time. The parametric values (min and max limits) shown in the Electrical Characteristics table are guaranteed. Other parametric values quoted in this data sheet are provided for guidance.