

AC/DC Converter

# PWM Type DC/DC Converter IC with Integrated Switching MOSFET

**BM2P0361K-Z**

**General Description**

The PWM type DC/DC converter for AC/DC provides an optimal system for all products that require an electrical outlet. This IC supports both isolated and non-isolated devices and enables simpler designs of various types of low power consumption electrical converters.

The built-in 800 V startup circuit contributes to low power consumption.

Power supplies can be designed flexibly by connecting a current detection resistor for the switching externally. Current is restricted in each cycle and excellent performances are demonstrated in a bandwidth and transient response since a current mode control is utilized. The switching frequency is 65 kHz by a fixed method. At light load, the frequency is reduced, and high efficiency is achieved. A built-in frequency hopping function also contributes to low EMI. A built-in 800 V switching MOSFET makes designs easy.

**Features**

- PWM Current Mode Method
- Frequency Hopping Function
- Burst Operation at Light Load
- Frequency Reduction Function
- Built-in 800 V Startup Circuit
- Built-in 800 V Switching MOSFET
- VCC UVLO (Under Voltage Lockout)
- VCC OVP (Over Voltage Protection)
- Soft Start Function
- FB OLP (Overload Protection)
- Over Current Detection Function per Cycle
- Over Current Detection AC Voltage Compensation Function
- SOURCE Pin Open Protection Function
- SOURCE Pin Short Protection Function
- SOURCE Pin Leading Edge Blanking Function

**Key Specifications**

- Operating Power Supply Voltage Range  
VCC Pin: 8.9 V to 26.0 V  
DRAIN Pin: 800 V (Max)
- Current at Switching Operation: 0.70 mA (Typ)
- Current at Burst Operation: 0.30 mA (Typ)
- Switching Frequency: 65 kHz (Typ)
- Operating Temperature Range: -40 °C to +105 °C
- MOSFET ON Resistance: 3.5 Ω (Typ)

**Package**

DIP7K

**W (Typ) x D (Typ) x H (Max)**

9.27 mm x 6.35 mm x 8.63 mm  
Pitch: 2.54 mm

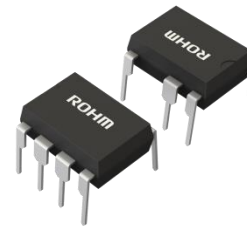

**Applications**

AC Adapters, Various Household Appliances (Such as Vacuum Cleaners, Humidifiers, Air Cleaners, Air Conditioners, IH Cooking Heaters and Rice Cookers)

**Typical Application Circuit**

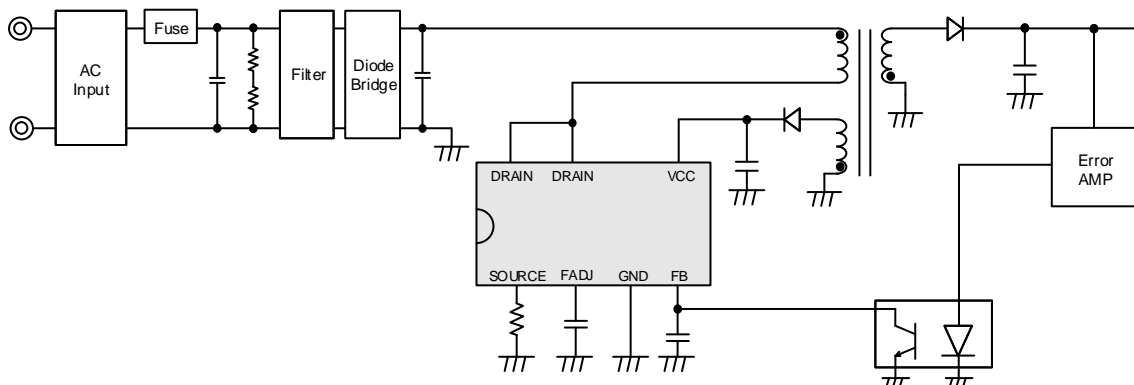

○Product structure : Silicon integrated circuit ○This product has no designed protection against radioactive rays.

Pin Configuration

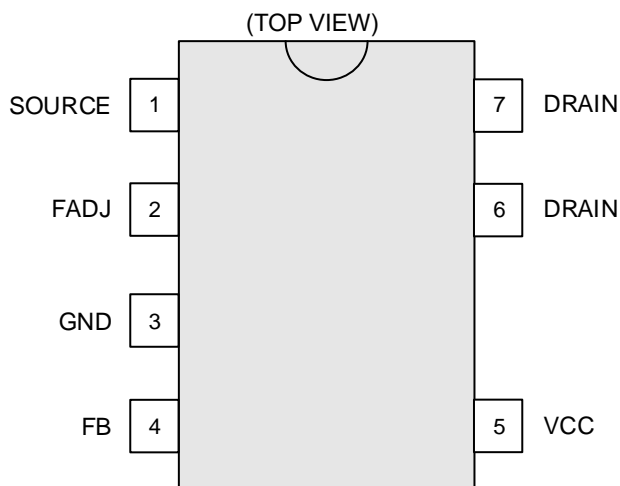

Pin Descriptions

Pin No.	Pin Name	I/O	Function	ESD Diode	
				VCC	GND
1	SOURCE	I/O	MOSFET SOURCE pin	○	○
2	FADJ	I	Burst frequency setting pin	○	○
3	GND	I/O	GND pin	○	-
4	FB	I	Feedback signal input pin	○	○
5	VCC	I	Power supply input pin	-	○
6	DRAIN	I/O	MOSFET DRAIN pin	-	-
7	DRAIN	I/O	MOSFET DRAIN pin	-	-

Block Diagram

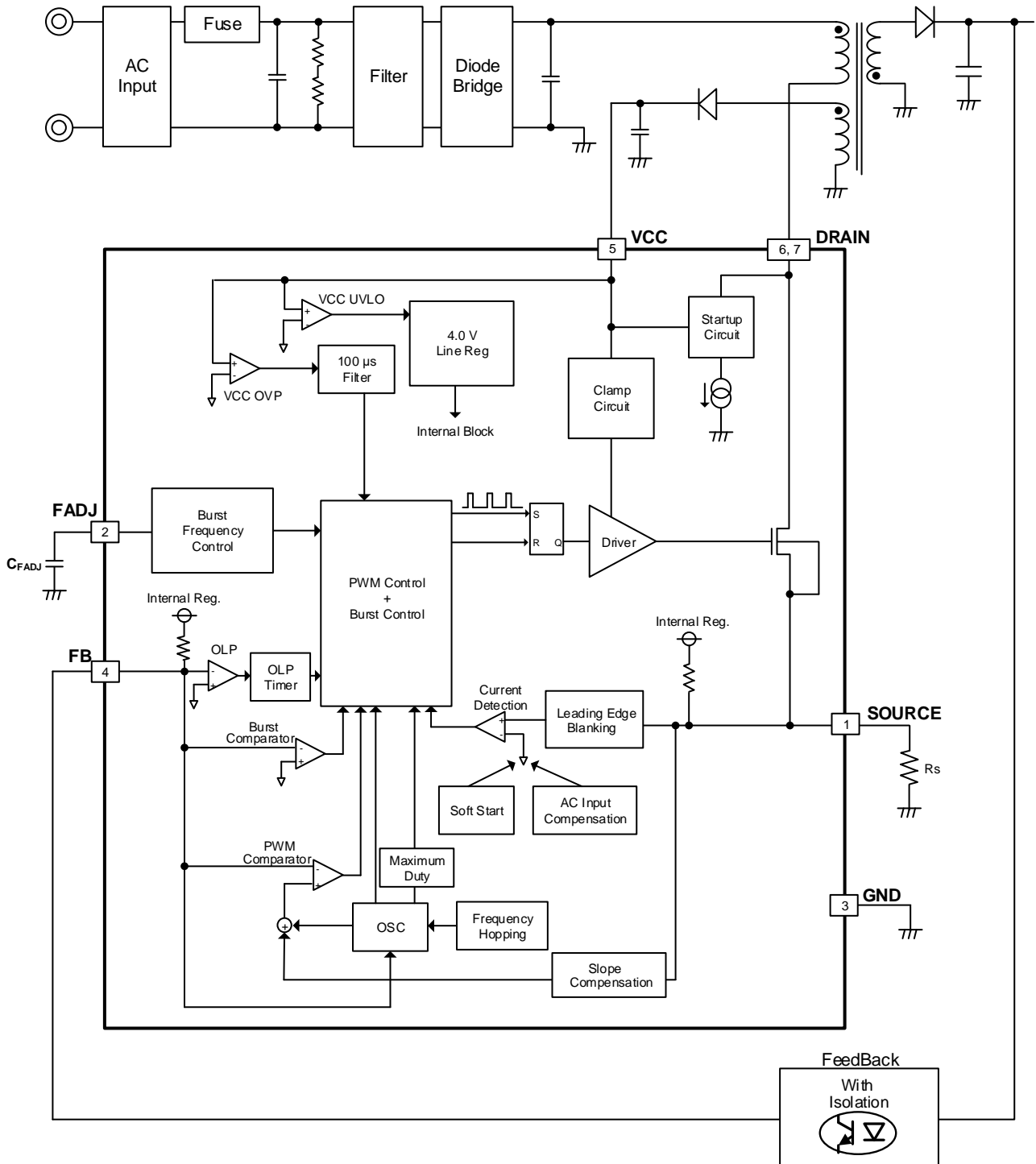

Description of Blocks

1 Startup Circuit

This IC has a built-in startup circuit. It enables low standby electricity and high-speed startup. The current consumption after startup is only OFF current  $I_{START3}$ . Reference values of startup time are shown in Figure 3. When  $C_{VCC} = 10 \mu\text{F}$ , it can start in 0.1 s or less.

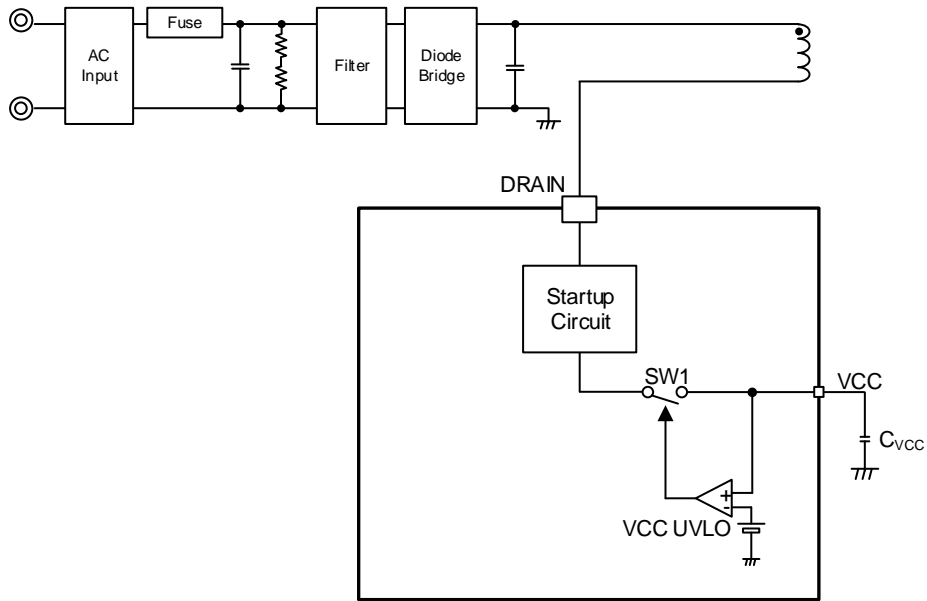

Figure 1. Block Diagram of Startup Circuit

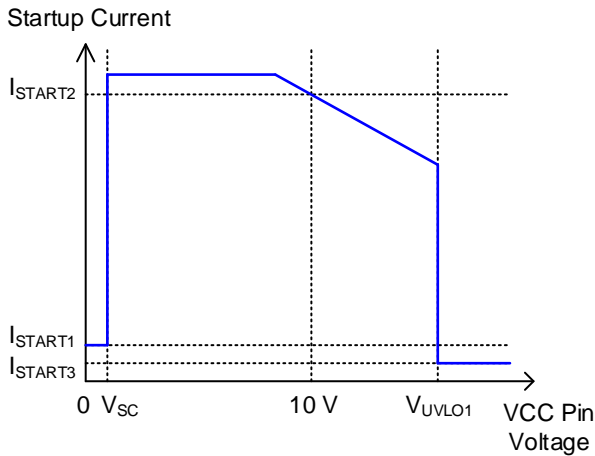

Figure 2. Startup Current vs VCC Pin Voltage

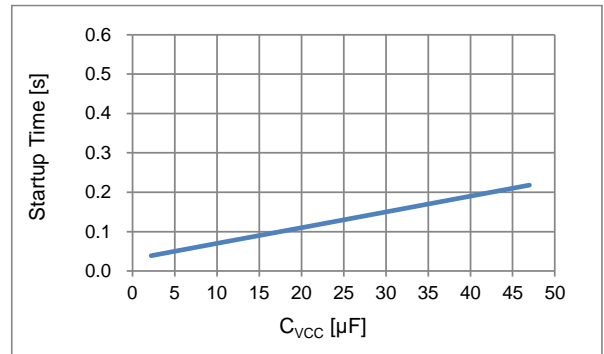

Figure 3. Startup Time vs  $C_{VCC}$

Description of Blocks - continued

2 Startup Sequences

Startup sequences are shown in Figure 4. See the sections below for detailed descriptions.

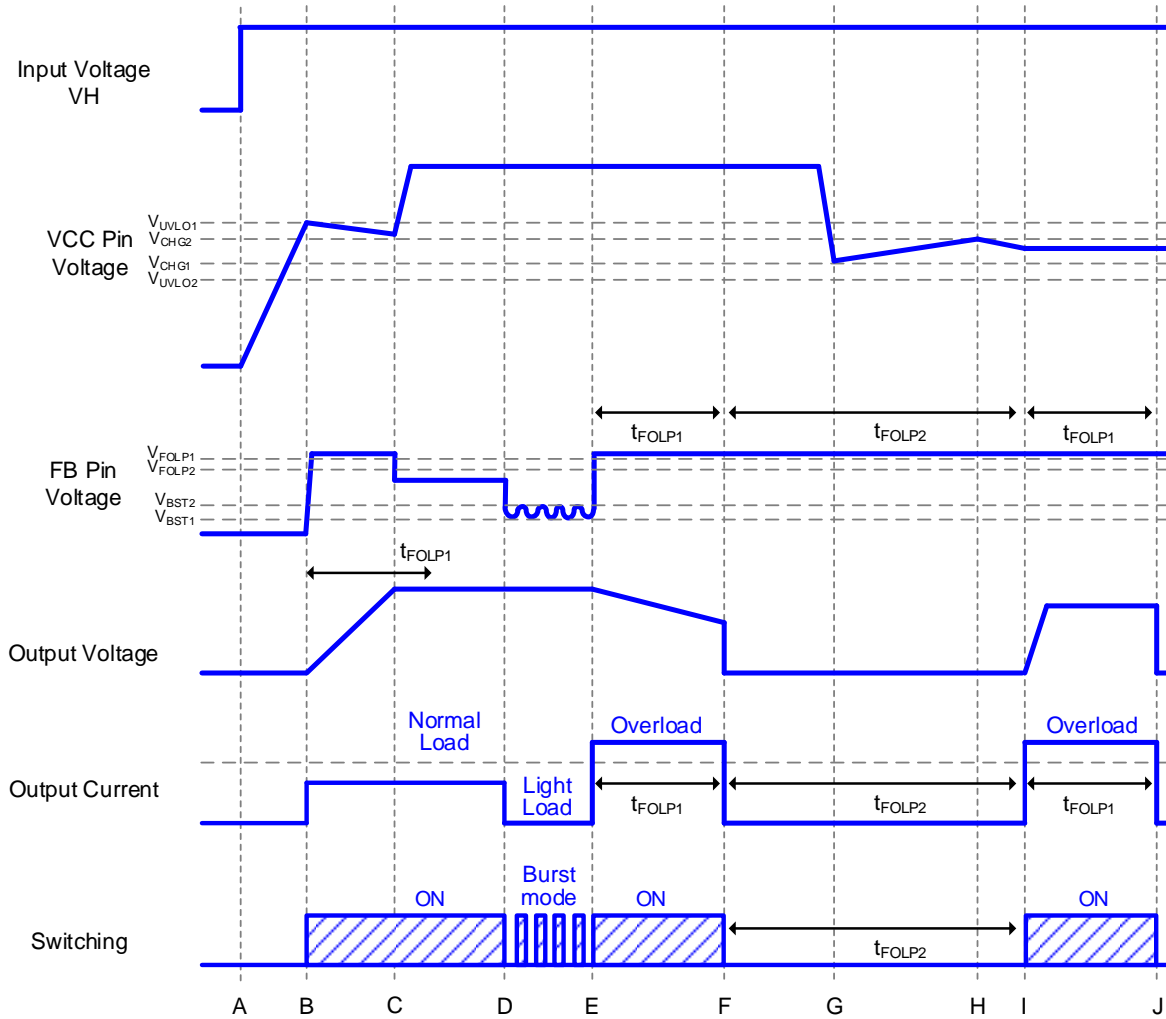

Figure 4. Startup Sequences Timing Chart

- A: The input voltage  $V_H$  is applied and the VCC pin voltage rises.
- B: If the VCC pin voltage becomes more than  $V_{UVLO1}$ , the IC starts to operate. And if the IC judges the other protection functions as normal condition, it starts the switching operation. The soft start function limits the over current detection voltage to prevent any excessive voltage or current rising. When the switching operation starts, the output voltage rises. Until the output voltage becomes a constant value or more from startup, the VCC pin voltage drops by the VCC pin current consumption. Also, after the switching operation starts, it is necessary that the output voltage is set to become the rated voltage within  $t_{FOLP1}$ .
- C: The output voltage becomes constant.
- D: At light load, the burst operation starts to reduce the power consumption if the FB pin voltage becomes less than  $V_{BST1}$ .
- E: When the FB pin voltage becomes more than  $V_{FOLP1}$ , the IC starts the overload operation.
- F: When the condition that the FB pin voltage more than  $V_{FOLP1}$  continues for  $t_{FOLP1}$ , the switching stops for  $t_{FOLP2}$  period by FB OLP. (If the FB pin voltage becomes less than  $V_{FOLP2}$ , FB OLP detection timer  $t_{FOLP1}$  is reset.)
- G: When the VCC pin voltage becomes less than  $V_{CHG1}$ , the VCC recharge function operates.
- H: When the VCC pin voltage becomes more than  $V_{CHG2}$ , the VCC recharge function stops operating.
- I: After  $t_{FOLP2}$  period from F, the switching operation starts.
- J: Same as F.

## Description of Blocks – continued

## 3 VCC Pin Protection Function

This IC has the internal protection functions at the VCC pin as shown below.

## 3.1 VCC UVLO/VCC OVP

VCC UVLO and VCC OVP are the auto recovery type comparator having voltage hysteresis.

## 3.2 VCC Recharge Function

If the VCC pin voltage drops to less than  $V_{CHG1}$  after once the VCC pin becomes more than  $V_{UVLO1}$  and the IC starts to operate, the VCC recharge function operates. At this time, the VCC pin is recharged from the DRAIN pin through the startup circuit. When the VCC pin voltage becomes more than  $V_{CHG2}$ , this recharge is stopped.

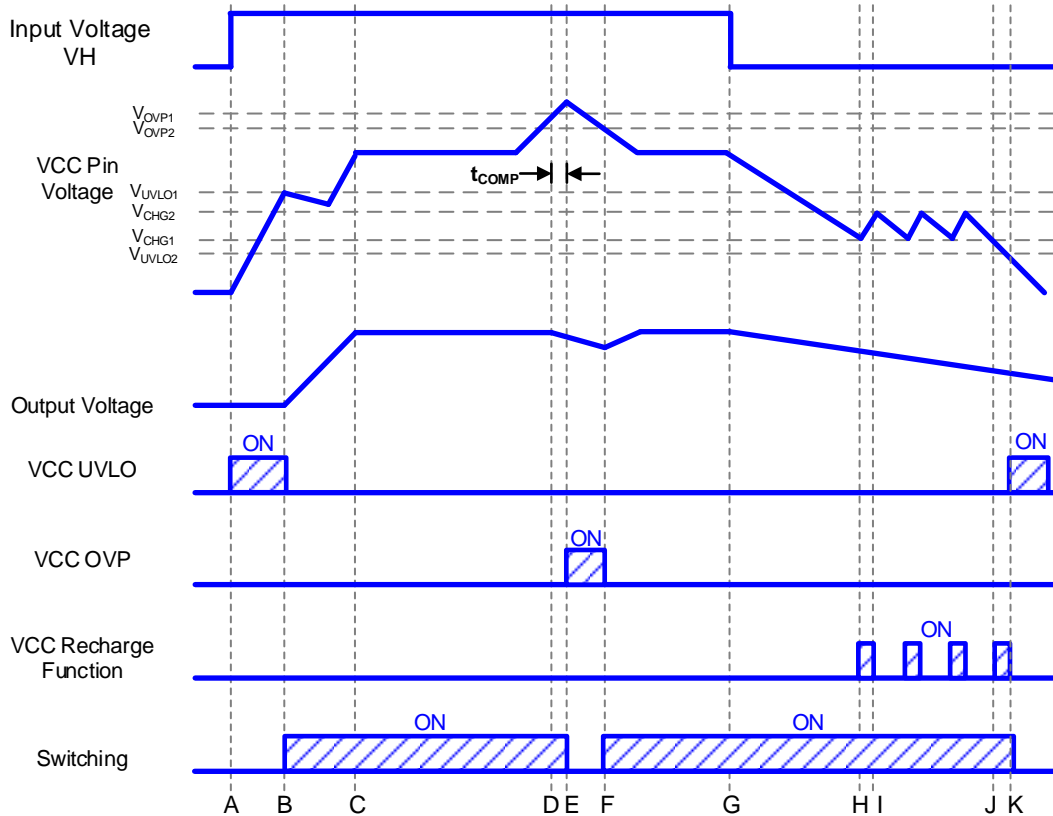

Figure 5. VCC UVLO/VCC OVP/VCC Recharge Function Timing Chart

- A: The input voltage  $V_H$  is applied and the VCC pin voltage rises.
- B: When the VCC pin voltage becomes more than  $V_{UVLO1}$ , the IC starts operating. And if the IC judges the other protection functions as normal condition, it starts switching operation. The soft start function limits the over current detection voltage value to prevent any excessive voltage or current rising. When the switching operation starts, the output voltage rises.
- C: The output voltage finishes startup. The VCC pin voltage is stabilized by being recharged from the auxiliary winding.
- D: When the VCC pin voltage becomes more than  $V_{OVP1}$ , VCC OVP timer operates.
- E: When the condition that the VCC pin voltage is more than  $V_{OVP1}$  lasts for  $t_{COMP}$ , VCC OVP operates and stops switching operation.
- F: When the VCC pin voltage becomes less than  $V_{OVP2}$ , VCC OVP is released and the switching operation restarts.
- G: When the input voltage  $V_H$  becomes OPEN, the VCC pin voltage drops.
- H: When the VCC pin voltage becomes less than  $V_{CHG1}$ , the VCC recharge function operates.
- I: When the VCC pin voltage becomes more than  $V_{CHG2}$ , the VCC recharge function stops its operation.
- J: When the VCC pin voltage becomes less than  $V_{CHG1}$ , the VCC recharge function operates. However, the current supply to the VCC pin decreases and the VCC pin voltage continues to drop because of the low input voltage  $V_H$ .
- K: When the VCC pin voltage becomes less than  $V_{UVLO2}$ , VCC UVLO operates.

3 VCC Pin Protection Function – continued

3.3 TSD (Thermal Shutdown)

TSD stops the switching operation if the junction temperature becomes more than  $T_{SD1}$ . When the junction temperature becomes less than  $T_{SD2}$ , the IC restarts the switching operation.

4 DC/DC Driver Block

This IC performs a current mode PWM control and it has the following characteristics.

- The switching frequency is fixed at  $f_{SW1}$  by an internal oscillator. It has a built-in frequency hopping function and it makes the switching frequency fluctuate as shown in Figure 6. The hopping fluctuation cycle is  $f_{CH}$ .
- Maximum duty is fixed at  $D_{MAX}$  and minimum ON time is fixed at  $t_{MIN}$ .
- In the current mode control, a sub-harmonic oscillation may occur when the duty cycle exceeds 50 %. As a countermeasure, this IC has a built-in slope compensation circuit.
- It has a built-in burst mode and frequency reduction circuits to achieve lower power consumption at light load.
- The FB pin is pulled up to the internal power supply by  $R_{FB}$ .
- The FB pin voltage is changed by the secondary output voltage. This IC monitors this and changes a switching operation status.

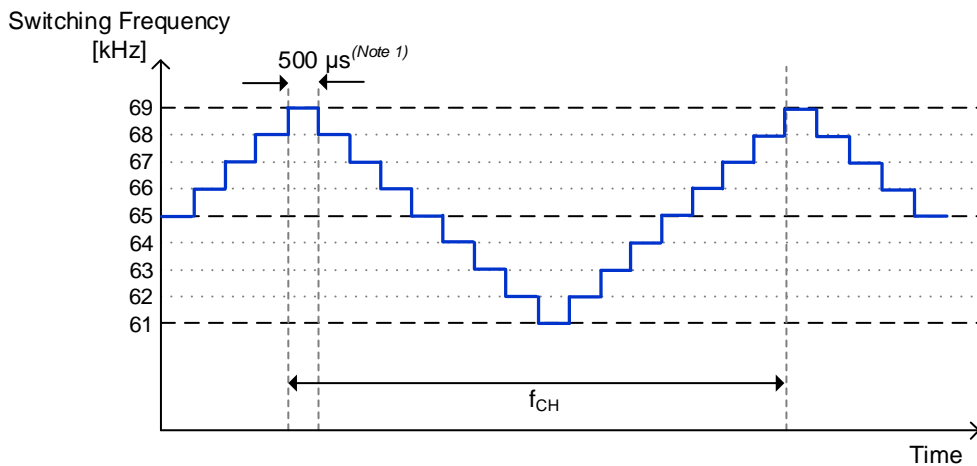

(Note 1) This is the value calculated as  $f_{CH}$  is typical value.

Figure 6. Frequency Hopping Function

4 DC/DC Driver Block – continued

4.1 Frequency Circuit and Setting Burst Frequency

This IC fixes the burst frequency by connecting a capacitor to the FADJ pin and it reduces the sound noise at the burst operation. The correlation between the capacitor connected to the FADJ pin and the FADJ pin maximum burst frequency is shown in the Figure 9.

- mode 1: Burst Operation
- mode 2: Frequency Modulation Operation
- mode 3: Fixed Frequency Operation
- mode 4: Overload Operation

- (The intermittent operation starts.)
- (It modulates the frequency.)
- (It operates in the maximum frequency.)
- (The intermittent operation starts.)

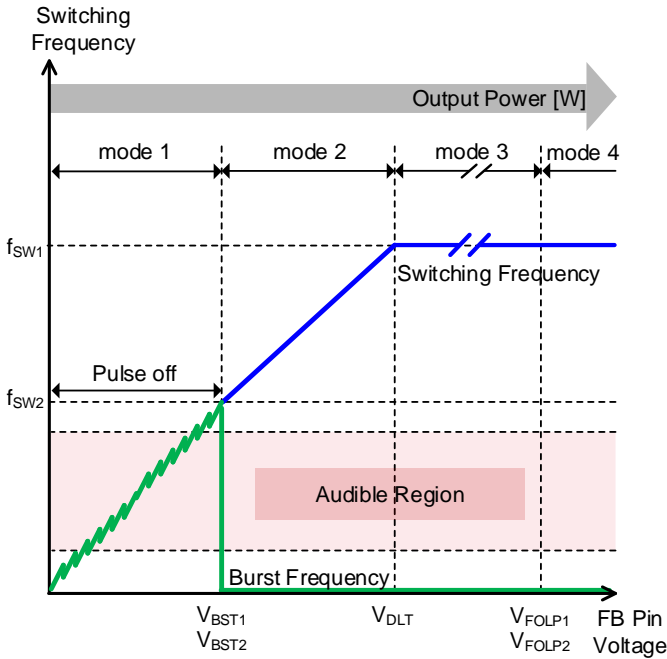

Figure 7. Without Connecting the Capacitor to the FADJ Pin

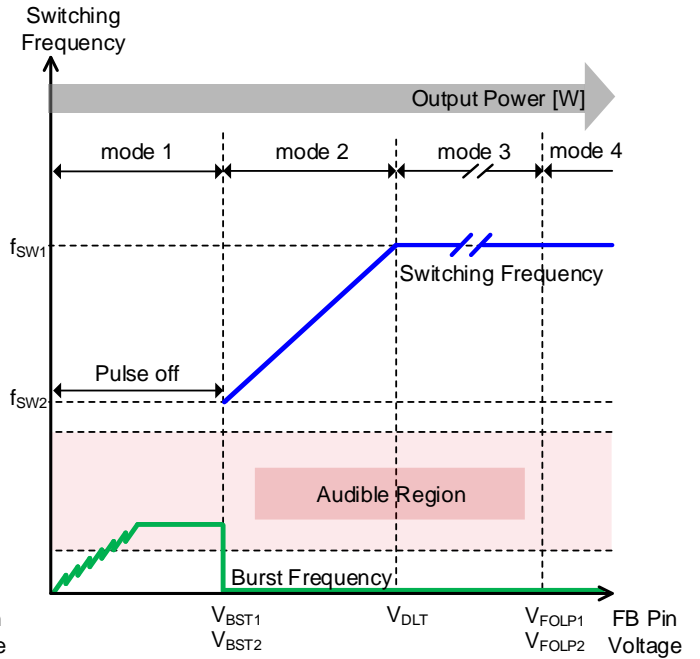

Figure 8. Connect the Capacitor to the FADJ Pin

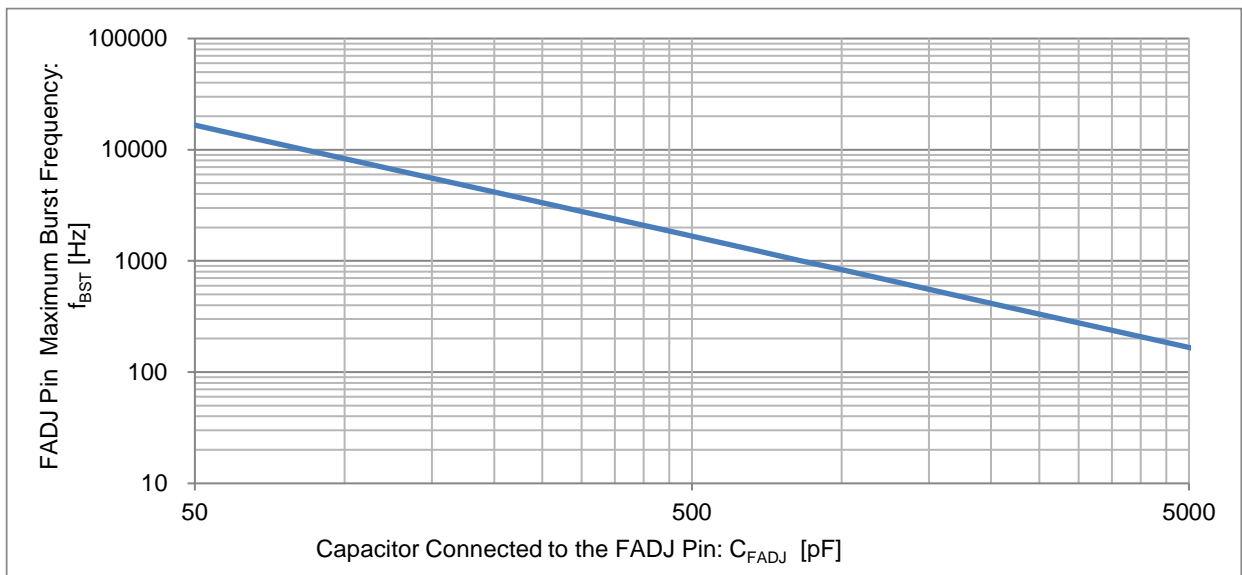

Figure 9. FADJ Pin Maximum Burst Frequency vs Capacitor Connected to the FADF Pin



4 DC/DC Driver Block – continued

4.2 Soft Start Function

At startup, this function controls the over current detection voltage in order to prevent any excessive voltage or current rising. This IC enables the soft start operation by changing the over current detection voltage with time.

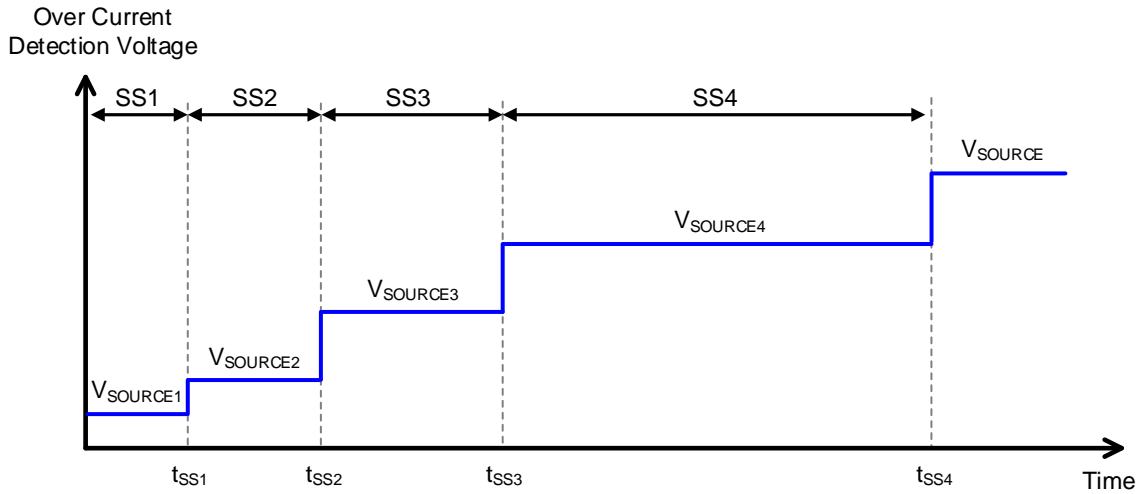

Figure 10. Soft Start Function

4.3. FB OLP (Overload Protection)

FB OLP is the function that monitors the secondary output load status at the FB pin voltage and stops the switching operation at the overload status.

At the overload status, the FB pin voltage rises because current does not flow to the photocoupler because of a drop of the output voltage. When the condition that the FB pin voltage  $> V_{FOLP1}$  continues for longer than  $t_{FOLP1}$ , it is judged as the overload status and the switching operation stops. If the FB pin voltage falls to less than  $V_{FOLP2}$  within  $t_{FOLP1}$  from the status that the FB pin voltage  $> V_{FOLP1}$ , FB OLP ON detection timer is reset.

At startup, the FB pin is pulled up to the IC's internal voltage, so the operation starts from the voltage more than  $V_{FOLP1}$ . Therefore, it is necessary to set the startup time so that the FB pin voltage becomes less than  $V_{FOLP1}$  within  $t_{FOLP1}$ .

Recovery from the detection of overload status is after  $t_{FOLP2}$ .

Description of Blocks – continued

5 Over Current Detection Block

5.1 Over Current Detection Function

This IC has a built-in over current detection function per switching cycle. If the SOURCE pin voltage becomes  $V_{SOURCE}$  ( $V_{SOURCE1}$  to  $V_{SOURCE4}$  in the case of SS1 to SS4) or more, the switching operation stops. It also has a built-in over current detection AC voltage compensation function. This function makes  $I_{PEAK}$  (DC) increase with time.

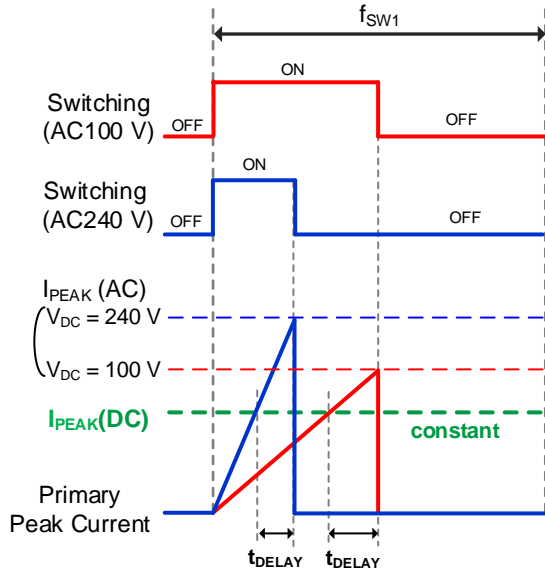

Figure 11. Without the AC Voltage Compensation Function

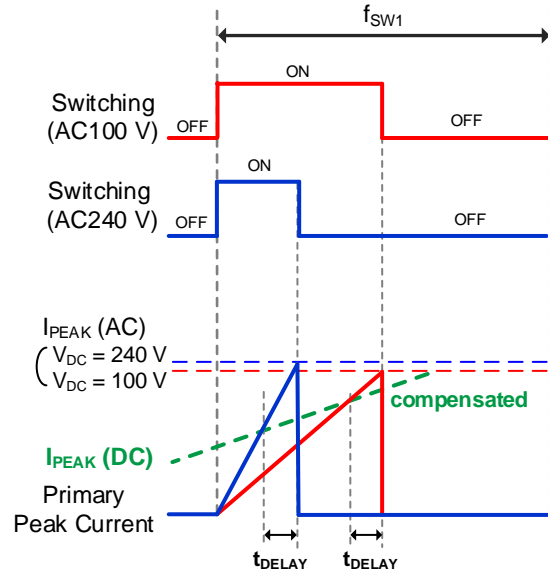

Figure 12. With the AC Voltage Compensation Function

Primary peak current entering overload mode is calculated by the following formula.

$$I_{PEAK} = \frac{V_{SOURCE}}{R_S} + \frac{V_{DC}}{L_p} \times t_{DELAY} \quad [A]$$

where:

- $I_{PEAK}$  is the primary peak current.
- $V_{SOURCE}$  is the over current detection voltage inside the IC.
- $R_S$  is the current detection resistor.
- $V_{DC}$  is the input DC voltage.
- $L_p$  is the primary transformer L value.
- $t_{DELAY}$  is the delay time after the over current detection.

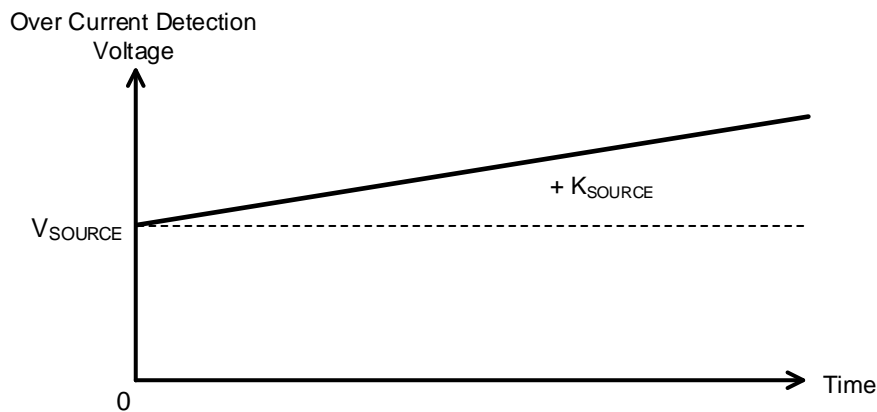

Figure 13. Over Current Detection Voltage

5 Over Current Detection Block – continued

5.2 SOURCE Pin Leading Edge Blanking Function

Normally, when the MOSFET for driver is turned ON, surge current is generated at each capacitor component, drive current and so on. At this time, detection errors may occur in the over current detection circuit because the SOURCE pin voltage rises. To prevent these errors, Leading Edge Blanking function is built in this IC. This function masks the SOURCE pin voltage for  $t_{LEB}$  from the time the DRAIN pin voltage switches H to L.

5.3 SOURCE Pin Short Protection Function

When the SOURCE pin is shorted, excessive heat may destroy the IC. To prevent this, this IC has a built-in short protection function (auto recovery).

5.4 SOURCE Pin Open Protection Function

When the SOURCE pin is opened, excessive heat by such as noise may destroy the IC. To prevent this, this IC has a built-in open protection function (auto recovery).

6 Operation Mode of Protection Functions

The operation modes of each protection function are shown in Table 1.

Table 1. Operation Modes of Protection Functions

	VCC UVLO	VCC OVP	TSD	FB OLP
Detection Conditions	VCC pin voltage < $V_{UVLO2}$ (at voltage dropping)	VCC pin voltage > $V_{OVP1}$ (at voltage rising)	Junction temperature > $T_{SD1}$ (at temperature rising)	FB pin voltage > $V_{FOLP1}$ (at voltage rising)
Release Conditions	VCC pin voltage > $V_{UVLO1}$ (at voltage rising)	VCC pin voltage < $V_{OVP2}$ (at voltage dropping)	Junction temperature < $T_{SD2}$ (at temperature dropping) or VCC UVLO detection	FB pin voltage < $V_{FOLP2}$ (at voltage falling) or VCC UVLO detection
Detection Timer	–	$t_{COMP}$	$t_{COMP}$	$t_{FOLP1}$
Release Timer	–	–	–	$t_{FOLP2}$
Auto Recovery or Latch	Auto recovery	Auto recovery	Auto recovery	Auto recovery

**Absolute Maximum Ratings (Ta = 25 °C)**

Parameter	Symbol	Rating	Unit	Conditions
Maximum Applied Voltage 1	V <sub>MAX1</sub>	-0.3 to +32	V	VCC pin voltage
Maximum Applied Voltage 2	V <sub>MAX2</sub>	-0.3 to +6.5	V	SOURCE and FB and FADJ pins voltage
Maximum Applied Voltage 3	V <sub>MAX3</sub>	-0.3 to +800	V	DRAIN pin voltage
DRAIN Pin Current (Pulse)	I <sub>DP</sub>	4.8	A	P <sub>W</sub> = 10 μs, Duty cycle = 1 %
Power Dissipation	Pd	1.00	W	(Note 1)
Maximum Junction Temperature	T <sub>jmax</sub>	150	°C	
Storage Temperature Range	T <sub>stg</sub>	-55 to +150	°C	

**Caution 1:** Operating the IC over the absolute maximum ratings may damage the IC. The damage can either be a short circuit between pins or an open circuit between pins and the internal circuitry. Therefore, it is important to consider circuit protection measures, such as adding a fuse, in case the IC is operated over the absolute maximum ratings.

**Caution 2:** Should by any chance the maximum junction temperature rating be exceeded the rise in temperature of the chip may result in deterioration of the properties of the chip. In case of exceeding this absolute maximum rating, design a PCB with power dissipation taken into consideration by increasing board size and copper area so as not to exceed the maximum junction temperature rating.

(Note 1) At mounted on a glass epoxy single layer PCB (74.2 mm x 74.2 mm, 1.6 mm). Derate by 8 mW/°C if the IC is used in the ambient temperature Ta 25 °C or above.

**Thermal Dissipation**

Make the thermal design so that the IC operates in the following conditions.  
(Because the following temperature is guarantee value, it is necessary to consider margin.)

1. The ambient temperature Ta must be 105 °C or less.
2. The IC's loss must be the power dissipation Pd or less.

The thermal abatement characteristic is as follows.  
(At mounting on a glass epoxy single layer PCB which size is 74.2 mm x 74.2 mm x 1.6 mm)

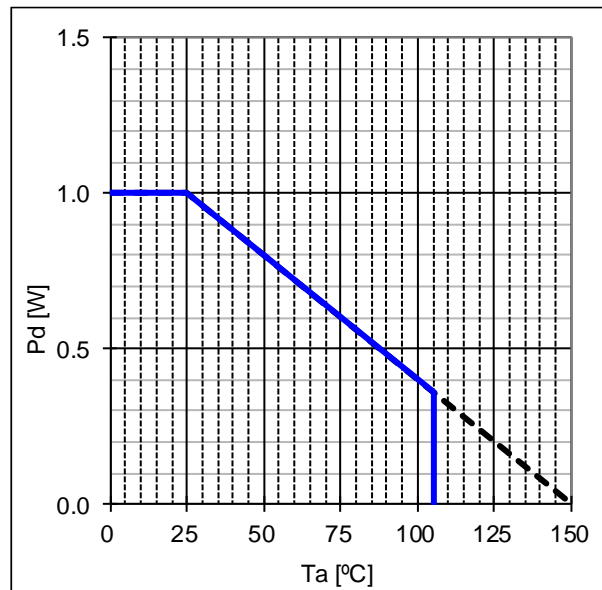

Figure 14. DIP7K Thermal Dissipation Characteristic

**Recommended Operating Conditions**

Parameter	Symbol	Min	Typ	Max	Unit	Conditions
Operating Power Supply Voltage Range 1	V <sub>CC</sub>	8.9	-	26.0	V	V <sub>CC</sub> pin voltage
Operating Power Supply Voltage Range 2	V <sub>DRAIN</sub>	-	-	800	V	DRAIN pin voltage
Operating Temperature	T <sub>opr</sub>	-40	-	+105	°C	

**Electrical Characteristics in MOSFET Part**(Unless otherwise noted, Ta = 25 °C, V<sub>CC</sub> = 15 V)

Parameter	Symbol	Min	Typ	Max	Unit	Conditions
Voltage between DRAIN and SOURCE Pins	V <sub>(BR)DDS</sub>	800	-	-	V	I <sub>D</sub> = 1 mA, V <sub>GS</sub> = 0 V
DRAIN Pin Leak Current	I <sub>DSS</sub>	-	-	100	μA	V <sub>DS</sub> = 800 V, V <sub>GS</sub> = 0 V
On Resistance	R <sub>DS(ON)</sub>	-	3.5	4.2	Ω	I <sub>D</sub> = 1.5 A, V <sub>GS</sub> = 10 V

**Electrical Characteristics in Startup Circuit Part**(Unless otherwise noted, Ta = 25 °C, V<sub>CC</sub> = 15 V)

Parameter	Symbol	Min	Typ	Max	Unit	Conditions
Startup Current 1	I <sub>START1</sub>	0.100	0.500	1.000	mA	V <sub>CC</sub> pin voltage = 0 V
Startup Current 2	I <sub>START2</sub>	1.00	3.00	6.00	mA	V <sub>CC</sub> pin voltage = 10 V
OFF Current	I <sub>START3</sub>	-	10	20	μA	Inflow current from the DRAIN pin after UVLO is released (at MOSFET OFF)
Startup Current Switching Voltage	V <sub>SC</sub>	0.800	1.500	2.100	V	

**Electrical Characteristics in Control IC Part**(Unless otherwise noted, Ta = 25 °C, V<sub>CC</sub> = 15 V)

Parameter	Symbol	Min	Typ	Max	Unit	Conditions
Circuit Current						
Current at Switching Operation	I <sub>ON1</sub>	0.35	0.70	1.05	mA	FB pin voltage = 2.0 V (pulse operation)
Current at Burst Operation	I <sub>ON2</sub>	0.20	0.30	0.45	mA	FB pin voltage = 0.0 V
VCC Pin Protection Function						
VCC UVLO Voltage 1	V <sub>UVLO1</sub>	12.50	13.50	14.50	V	At VCC pin voltage rising
VCC UVLO Voltage 2	V <sub>UVLO2</sub>	7.50	8.20	8.90	V	At VCC pin voltage falling
VCC UVLO Voltage Hysteresis	V <sub>UVLO3</sub>	-	5.30	-	V	V <sub>UVLO3</sub> = V <sub>UVLO1</sub> - V <sub>UVLO2</sub>
VCC OVP Voltage 1	V <sub>OVP1</sub>	26.0	27.5	29.0	V	At VCC pin voltage rising
VCC OVP Voltage 2	V <sub>OVP2</sub>	22.0	23.5	25.0	V	At VCC pin voltage falling
VCC OVP Voltage Hysteresis	V <sub>OVP3</sub>	-	4.0	-	V	V <sub>OVP3</sub> = V <sub>OVP1</sub> - V <sub>OVP2</sub>
VCC Recharge Start Voltage	V <sub>CHG1</sub>	7.70	8.70	9.70	V	
VCC Recharge Stop Voltage	V <sub>CHG2</sub>	12.00	13.00	14.00	V	
TSD Temperature 1	T <sub>SD1</sub>	120	145	170	°C	At temperature rising <sup>(Note 1)</sup>
TSD Temperature 2	T <sub>SD2</sub>	90	115	140	°C	At temperature falling <sup>(Note 1)</sup>
VCC OVP/TSD Timer	t <sub>COMP</sub>	50	100	150	μs	

(Note 1) Not 100 % tested.

## Electrical Characteristics in Control IC Part – continued

(Unless otherwise noted, Ta = 25 °C, VCC = 15 V)

Parameter	Symbol	Min	Typ	Max	Unit	Conditions
DC/DC Driver Block						
Switching Frequency 1	f <sub>SW1</sub>	60	65	70	kHz	FB pin voltage = 2.00 V
Switching Frequency 2	f <sub>SW2</sub>	20	25	30	kHz	FB pin voltage = 0.30 V
Frequency Hopping Width	f <sub>DEL</sub>	-	4.0	-	kHz	FB pin voltage = 2.0 V
Hopping Fluctuation Cycle	f <sub>CH</sub>	75	125	175	Hz	
FADJ Pin Current	I <sub>FADJ</sub>	0.80	1.00	1.20	μA	FADJ pin voltage = 0.0 V
FADJ Pin Comparator Voltage	V <sub>FADJ</sub>	1.13	1.20	1.27	V	
FADJ Pin Maximum Burst Frequency	f <sub>BST</sub>	-	0.833	-	kHz	C <sub>FADJ</sub> = 1000 pF
Soft Start Time 1	t <sub>SS1</sub>	0.30	0.50	0.70	ms	
Soft Start Time 2	t <sub>SS2</sub>	0.60	1.00	1.40	ms	
Soft Start Time 3	t <sub>SS3</sub>	1.20	2.00	2.80	ms	
Soft Start Time 4	t <sub>SS4</sub>	3.20	4.00	4.80	ms	
Maximum Duty	D <sub>MAX</sub>	68.0	75.0	82.0	%	
Minimum ON Time	t <sub>MIN</sub>	150	400	650	ns	(Note 1)
FB Pin Pull-up Resistance	R <sub>FB</sub>	23	30	37	kΩ	
ΔFB Pin/ΔSOURCE Pin Voltage Gain	Gain	3.00	4.00	7.00	V/V	
FB Pin Burst Voltage 1	V <sub>BST1</sub>	0.220	0.280	0.340	V	At FB pin voltage falling
FB Pin Burst Voltage 2	V <sub>BST2</sub>	0.260	0.320	0.380	V	At FB pin voltage rising
FB Pin Burst Voltage Hysteresis	V <sub>BST3</sub>	-	0.040	-	V	V <sub>BST3</sub> = V <sub>BST2</sub> - V <sub>BST1</sub>
FB Pin Voltage at Starting Frequency Reduction	V <sub>DLT</sub>	1.100	1.250	1.400	V	
FB OLP Voltage 1	V <sub>FOLP1</sub>	2.60	2.80	3.00	V	At overload detection (at FB pin voltage rising)
FB OLP Voltage 2	V <sub>FOLP2</sub>	2.40	2.60	2.80	V	At overload detection (at FB pin voltage falling)
FB OLP ON Detection Timer	t <sub>FOLP1</sub>	80	128	176	ms	
FB OLP OFF Timer	t <sub>FOLP2</sub>	332	512	692	ms	
Over Current Detection Block						
Over Current Detection Voltage	V <sub>SOURCE</sub>	0.375	0.400	0.425	V	t <sub>ON</sub> = 0 μs
Over Current Detection Voltage 1	V <sub>SOURCE1</sub>	0.050	0.100	0.150	V	(Note 1) (Note 2)
Over Current Detection Voltage 2	V <sub>SOURCE2</sub>	0.080	0.150	0.220	V	(Note 1) (Note 2)
Over Current Detection Voltage 3	V <sub>SOURCE3</sub>	0.130	0.200	0.270	V	(Note 1) (Note 2)
Over Current Detection Voltage 4	V <sub>SOURCE4</sub>	0.230	0.300	0.370	V	(Note 1) (Note 2)
Over Current Detection AC Voltage Compensation Factor	K <sub>SOURCE</sub>	12	20	28	mV/μs	
Leading Edge Blanking Time	t <sub>LEB</sub>	120	250	380	ns	(Note 1)
SOURCE Pin Short Protection Voltage	V <sub>SOURCESHT</sub>	0.020	0.050	0.080	V	
SOURCE Pin Short Protection Time	t <sub>SOURCESHT</sub>	1.80	3.00	4.20	μs	

(Note 1) Not 100 % tested.

(Note 2) Refer to Figure 10.

Typical Performance Curves  
(Reference Data)

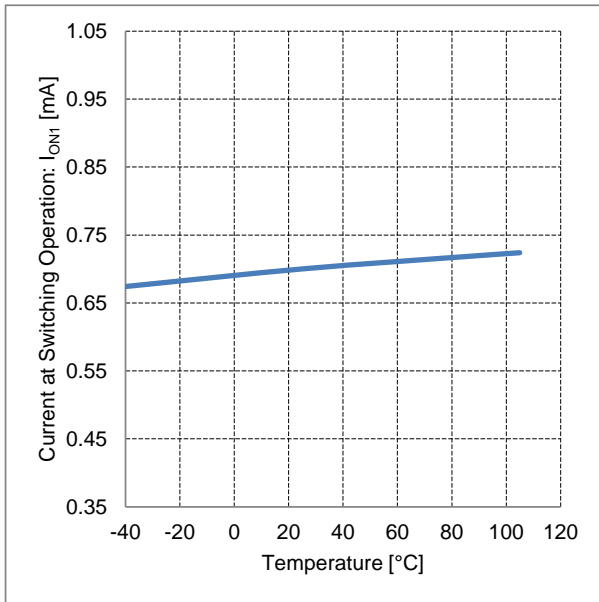

Figure 15. Current at Switching Operation vs Temperature

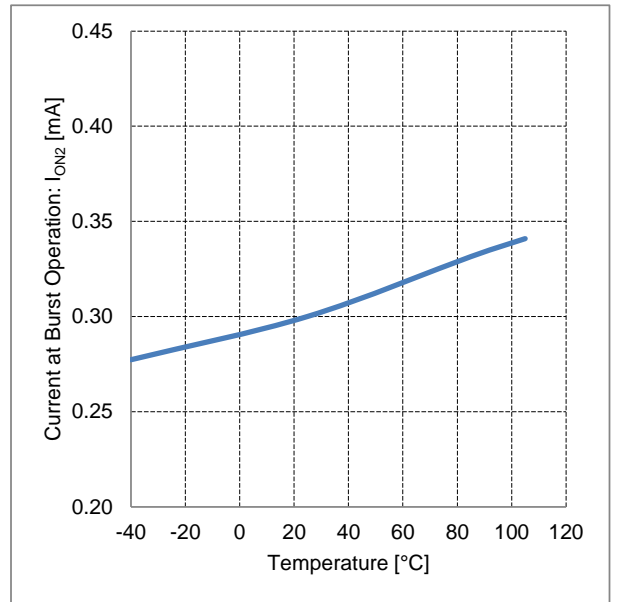

Figure 16. Current at Burst Operation vs Temperature

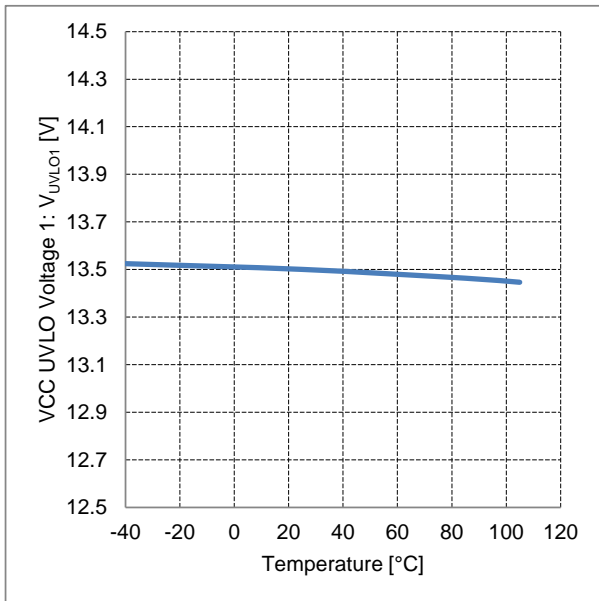

Figure 17. VCC UVLO Voltage 1 vs Temperature

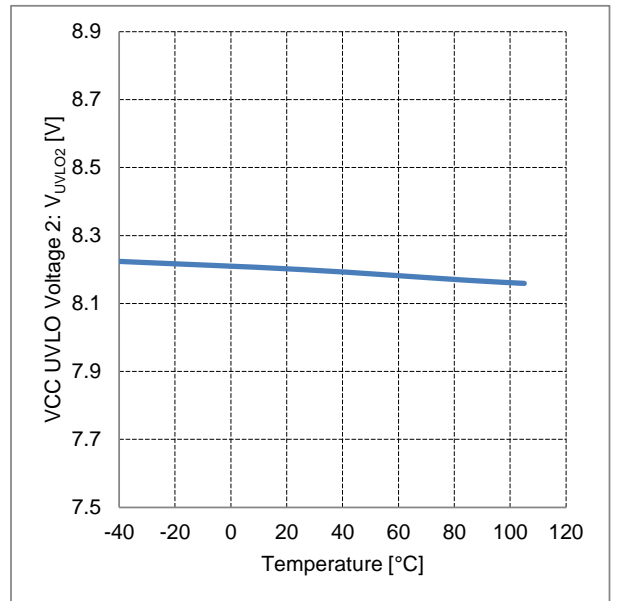

Figure 18. VCC UVLO Voltage 2 vs Temperature

Typical Performance Curves – continued  
(Reference Data)

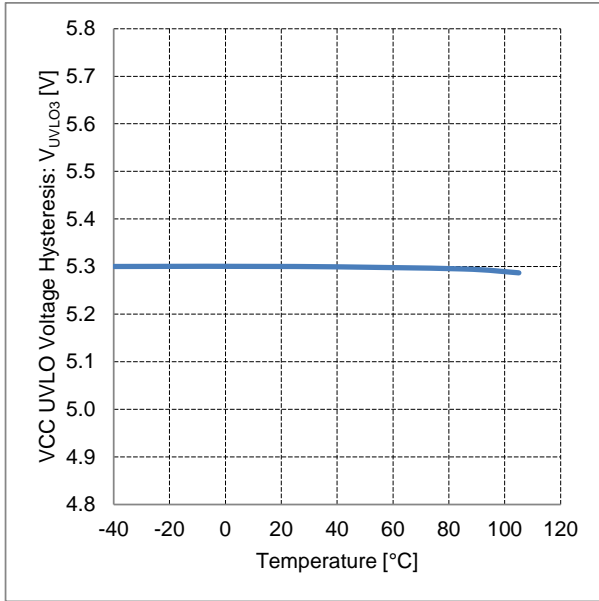

Figure 19. VCC UVLO Voltage Hysteresis vs Temperature

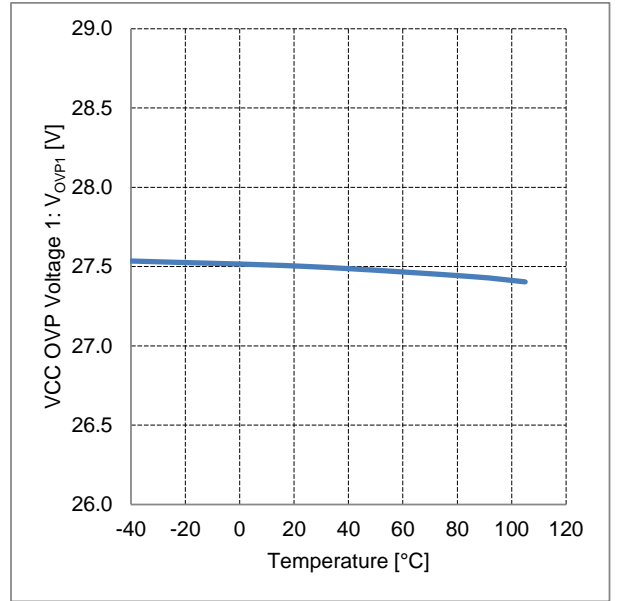

Figure 20. VCC OVP Voltage 1 vs Temperature

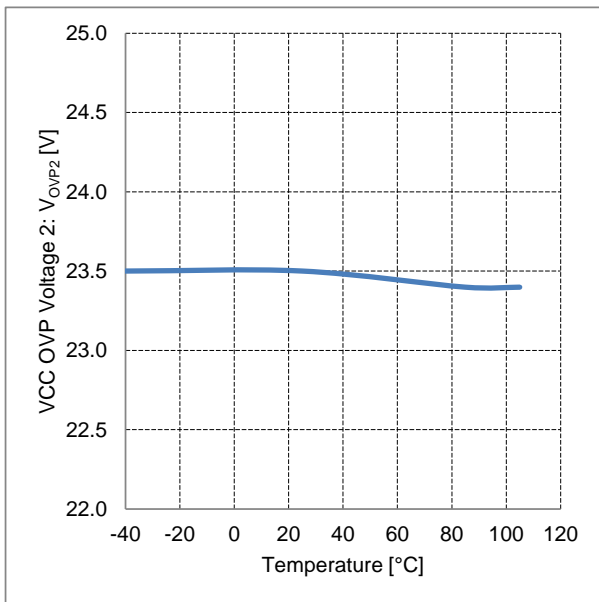

Figure 21. VCC OVP Voltage 2 vs Temperature

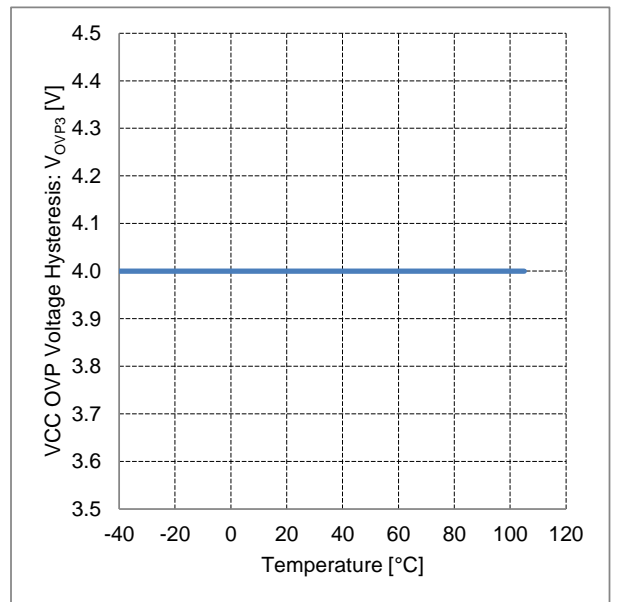

Figure 22. VCC OVP Voltage Hysteresis vs Temperature



Typical Performance Curves – continued  
(Reference Data)

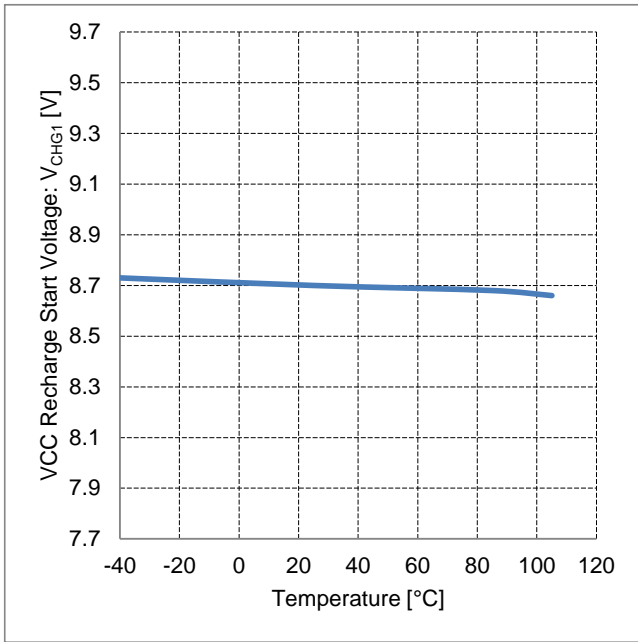

Figure 23. VCC Recharge Start Voltage vs Temperature

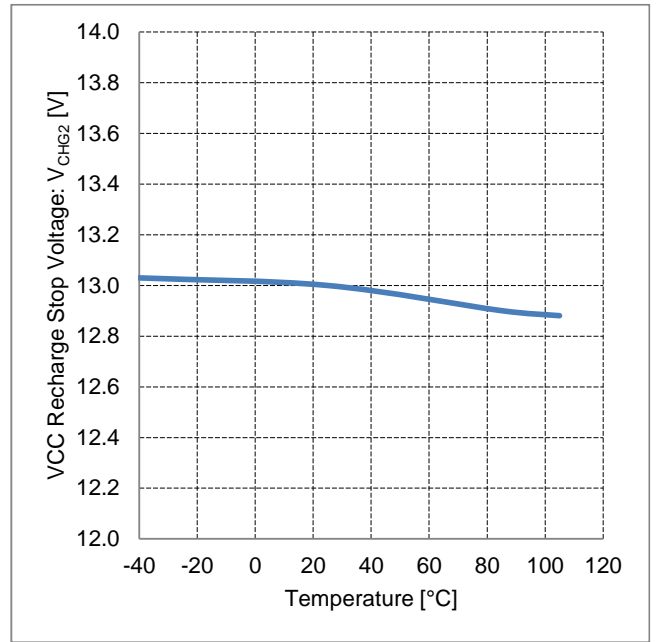

Figure 24. VCC Recharge Stop Voltage vs Temperature

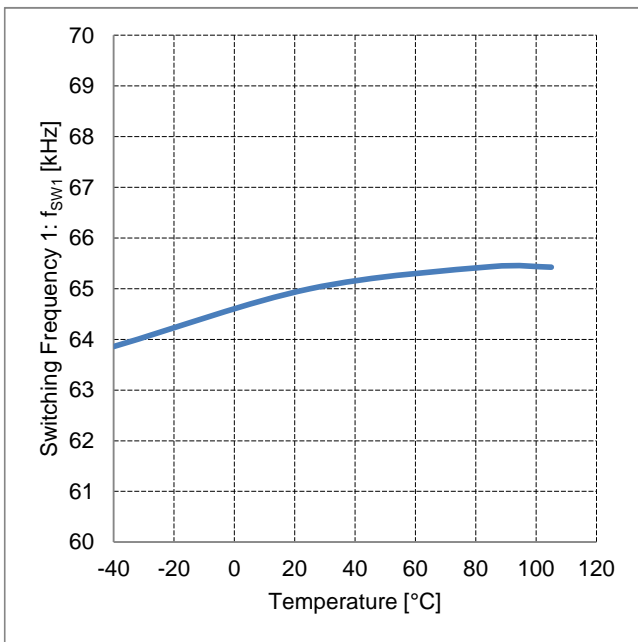

Figure 25. Switching Frequency 1 vs Temperature

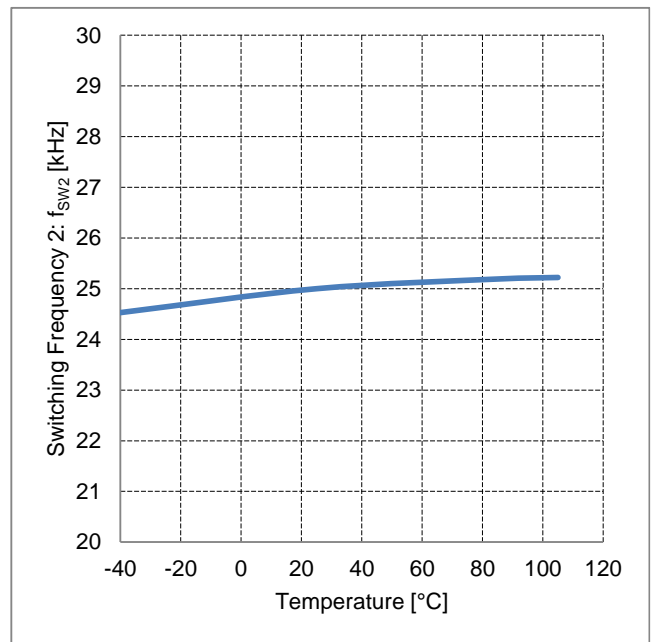

Figure 26. Switching Frequency 2 vs Temperature

Typical Performance Curves – continued  
(Reference Data)

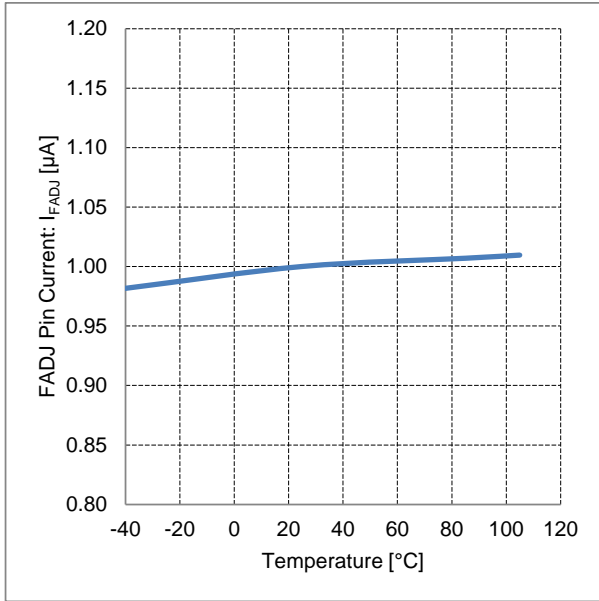

Figure 27. FADJ Pin Current vs Temperature

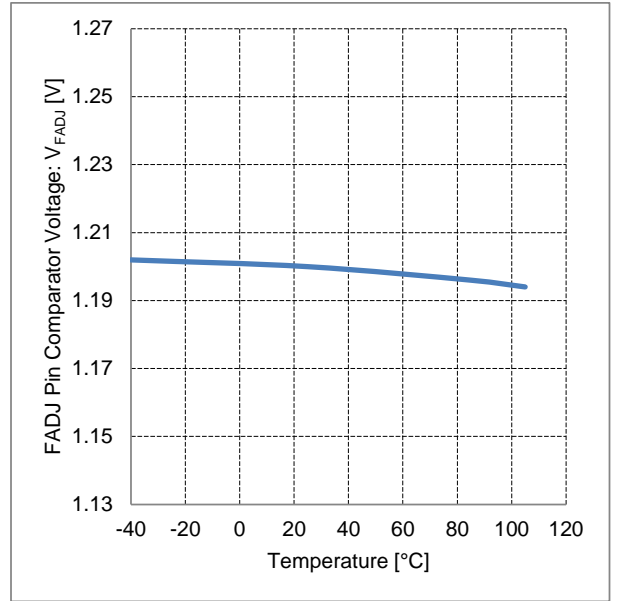

Figure 28. FADJ Pin Comparator Voltage vs Temperature

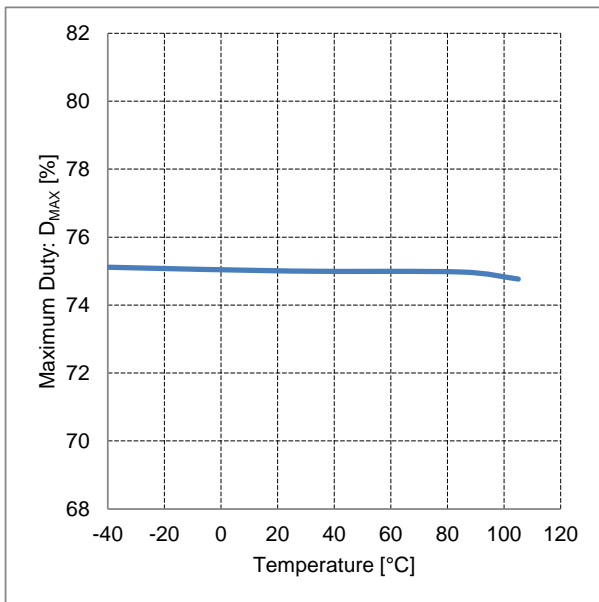

Figure 29. Maximum Duty vs Temperature

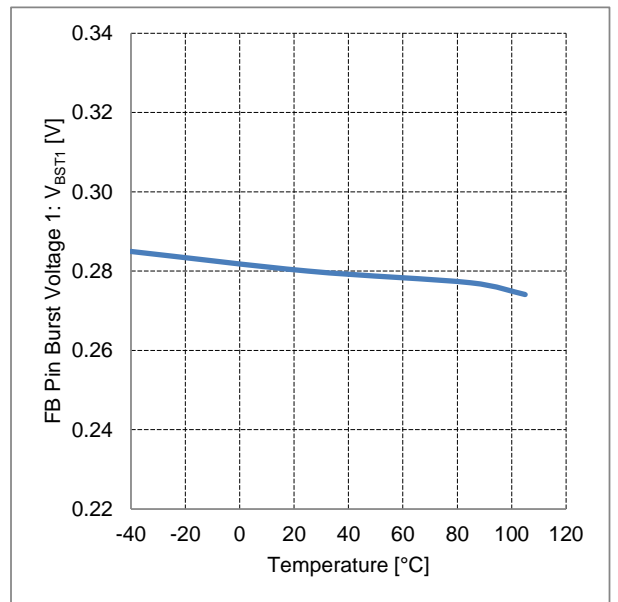

Figure 30. FB Pin Burst Voltage 1 vs Temperature

Typical Performance Curves – continued  
(Reference Data)

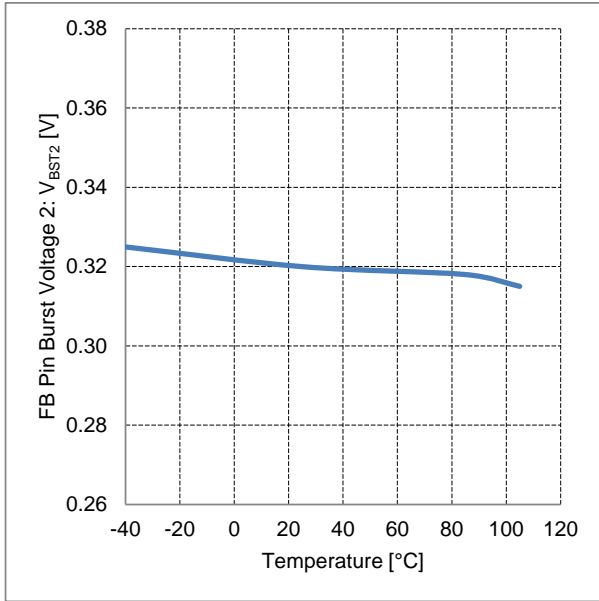

Figure 31. FB Pin Burst Voltage 2 vs Temperature

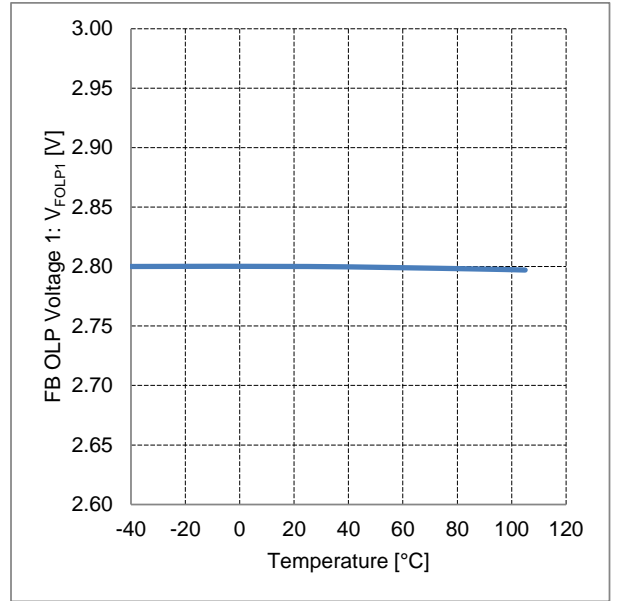

Figure 32. FB OLP Voltage 1 vs Temperature

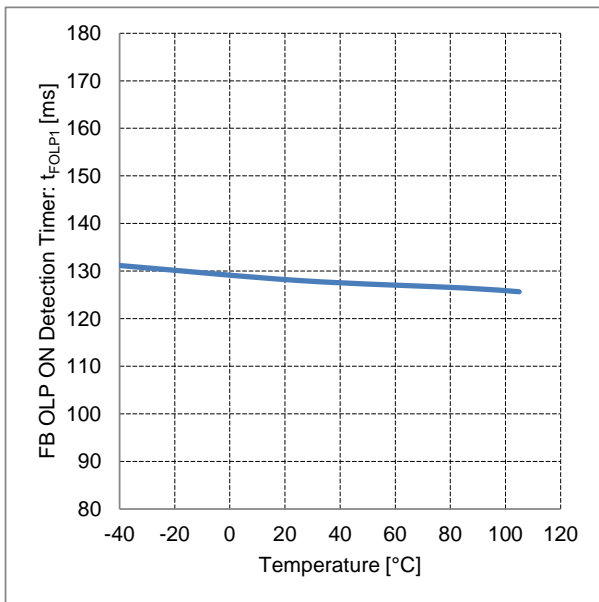

Figure 33. FB OLP ON Detection Timer vs Temperature

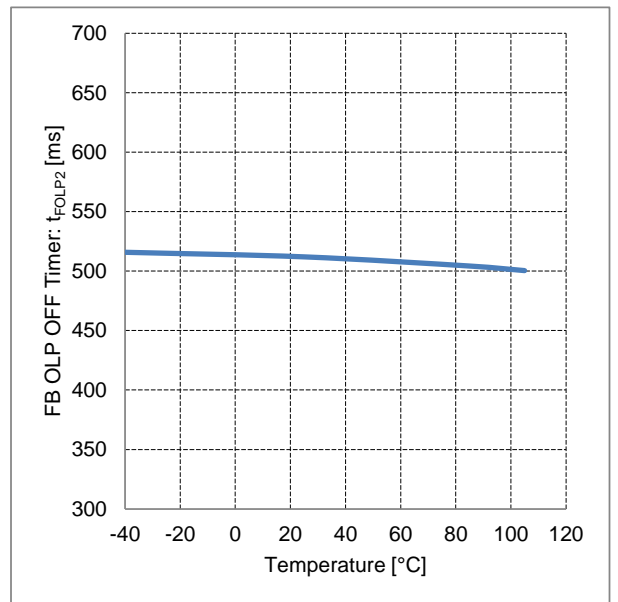

Figure 34. FB OLP OFF Timer vs Temperature

Typical Performance Curves – continued  
(Reference Data)

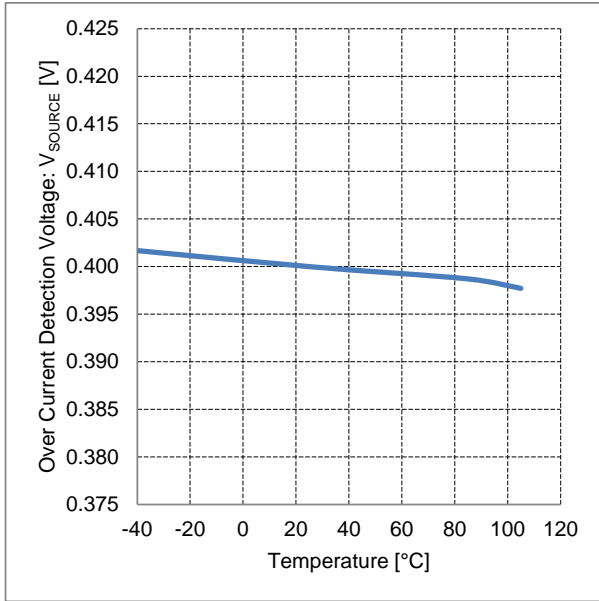

Figure 35. Over Current Detection Voltage vs Temperature

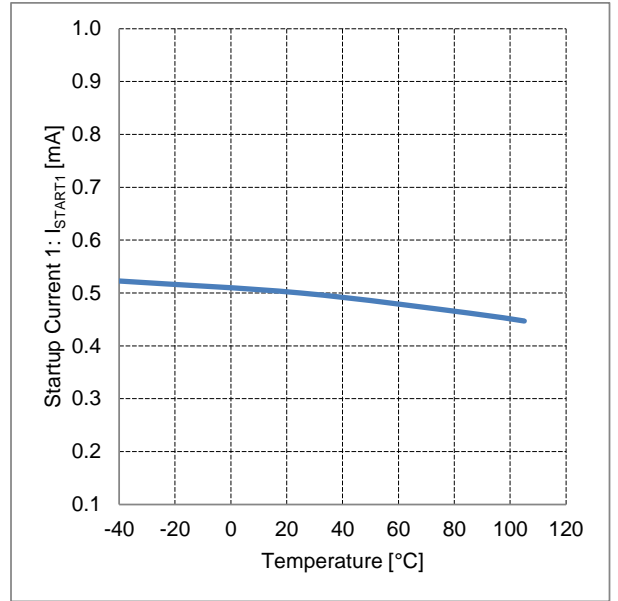

Figure 36. Startup Current 1 vs Temperature

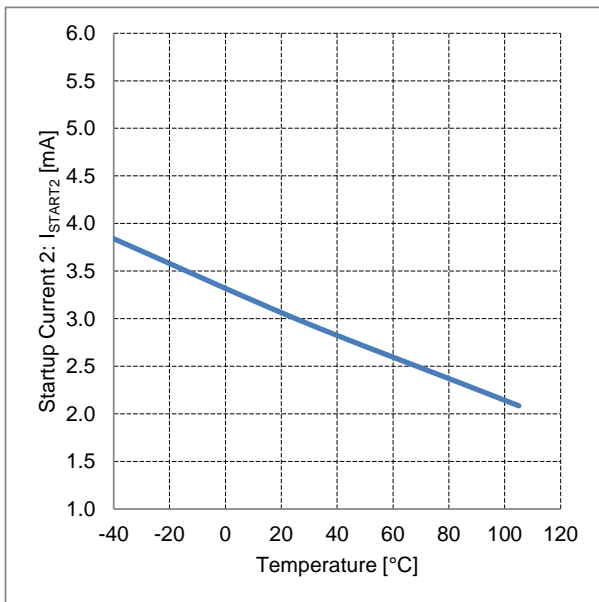

Figure 37. Startup Current 2 vs Temperature

I/O Equivalence Circuit

1	SOURCE	2	FADJ	3	GND	4	FB
5	VCC	-	-	6	DRAIN	7	DRAIN
		-					

## Operational Notes

### 1. Reverse Connection of Power Supply

Connecting the power supply in reverse polarity can damage the IC. Take precautions against reverse polarity when connecting the power supply, such as mounting an external diode between the power supply and the IC's power supply pins.

### 2. Power Supply Lines

Design the PCB layout pattern to provide low impedance supply lines. Furthermore, connect a capacitor to ground at all power supply pins. Consider the effect of temperature and aging on the capacitance value when using electrolytic capacitors.

### 3. Ground Voltage

Ensure that no pins are at a voltage below that of the ground pin at any time, even during transient condition.

### 4. Ground Wiring Pattern

When using both small-signal and large-current ground traces, the two ground traces should be routed separately but connected to a single ground at the reference point of the application board to avoid fluctuations in the small-signal ground caused by large currents. Also ensure that the ground traces of external components do not cause variations on the ground voltage. The ground lines must be as short and thick as possible to reduce line impedance.

### 5. Recommended Operating Conditions

The function and operation of the IC are guaranteed within the range specified by the recommended operating conditions. The characteristic values are guaranteed only under the conditions of each item specified by the electrical characteristics.

### 6. Inrush Current

When power is first supplied to the IC, it is possible that the internal logic may be unstable and inrush current may flow instantaneously due to the internal powering sequence and delays, especially if the IC has more than one power supply. Therefore, give special consideration to power coupling capacitance, power wiring, width of ground wiring, and routing of connections.

### 7. Testing on Application Boards

When testing the IC on an application board, connecting a capacitor directly to a low-impedance output pin may subject the IC to stress. Always discharge capacitors completely after each process or step. The IC's power supply should always be turned off completely before connecting or removing it from the test setup during the inspection process. To prevent damage from static discharge, ground the IC during assembly and use similar precautions during transport and storage.

### 8. Inter-pin Short and Mounting Errors

Ensure that the direction and position are correct when mounting the IC on the PCB. Incorrect mounting may result in damaging the IC. Avoid nearby pins being shorted to each other especially to ground, power supply and output pin. Inter-pin shorts could be due to many reasons such as metal particles, water droplets (in very humid environment) and unintentional solder bridge deposited in between pins during assembly to name a few.

### 9. Unused Input Pins

Input pins of an IC are often connected to the gate of a MOS transistor. The gate has extremely high impedance and extremely low capacitance. If left unconnected, the electric field from the outside can easily charge it. The small charge acquired in this way is enough to produce a significant effect on the conduction through the transistor and cause unexpected operation of the IC. So unless otherwise specified, unused input pins should be connected to the power supply or ground line.

Operational Notes – continued

10. Regarding the Input Pin of the IC

This IC contains P+ isolation and P substrate layers between adjacent elements in order to keep them isolated. P-N junctions are formed at the intersection of the P layers with the N layers of other elements, creating a parasitic diode or transistor. For example (refer to figure below):

When GND > Pin A and GND > Pin B, the P-N junction operates as a parasitic diode.  
 When GND > Pin B, the P-N junction operates as a parasitic transistor.

Parasitic diodes inevitably occur in the structure of the IC. The operation of parasitic diodes can result in mutual interference among circuits, operational faults, or physical damage. Therefore, conditions that cause these diodes to operate, such as applying a voltage lower than the GND voltage to an input pin (and thus to the P substrate) should be avoided.

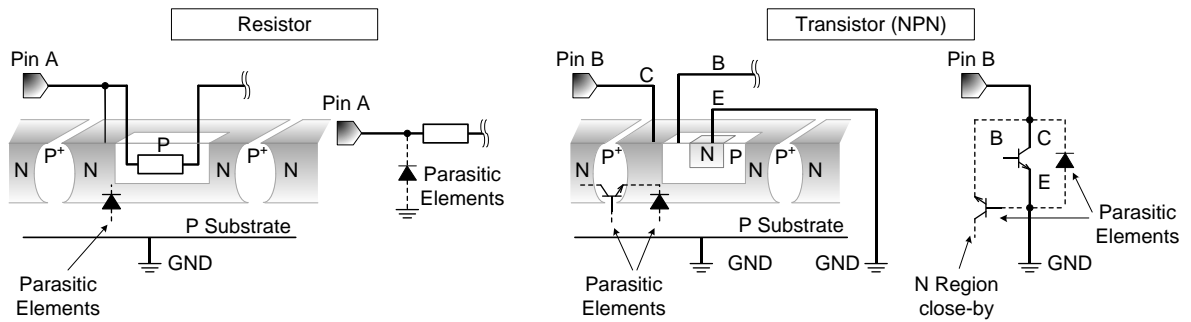

Figure 38. Example of IC Structure

11. Ceramic Capacitor

When using a ceramic capacitor, determine a capacitance value considering the change of capacitance with temperature and the decrease in nominal capacitance due to DC bias and others.

12. Thermal Shutdown Circuit (TSD)

This IC has a built-in thermal shutdown circuit that prevents heat damage to the IC. Normal operation should always be within the IC's maximum junction temperature rating. If however the rating is exceeded for a continued period, the junction temperature (T<sub>j</sub>) will rise which will activate the TSD circuit that will turn OFF power output pins. When the T<sub>j</sub> falls below the TSD threshold, the circuits are automatically restored to normal operation.

Note that the TSD circuit operates in a situation that exceeds the absolute maximum ratings and therefore, under no circumstances, should the TSD circuit be used in a set design or for any purpose other than protecting the IC from heat damage.

13. Over Current Protection Circuit (OCP)

This IC incorporates an integrated overcurrent protection circuit that is activated when the load is shorted. This protection circuit is effective in preventing damage due to sudden and unexpected incidents. However, the IC should not be used in applications characterized by continuous operation or transitioning of the protection circuit.

Ordering Information

B M 2 P 0 3 6 1 K - Z

Marking Diagram

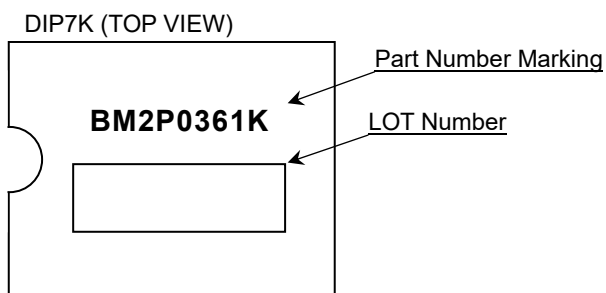



Physical Dimension and Packing Information

Package Name	DIP7K
--------------	-------

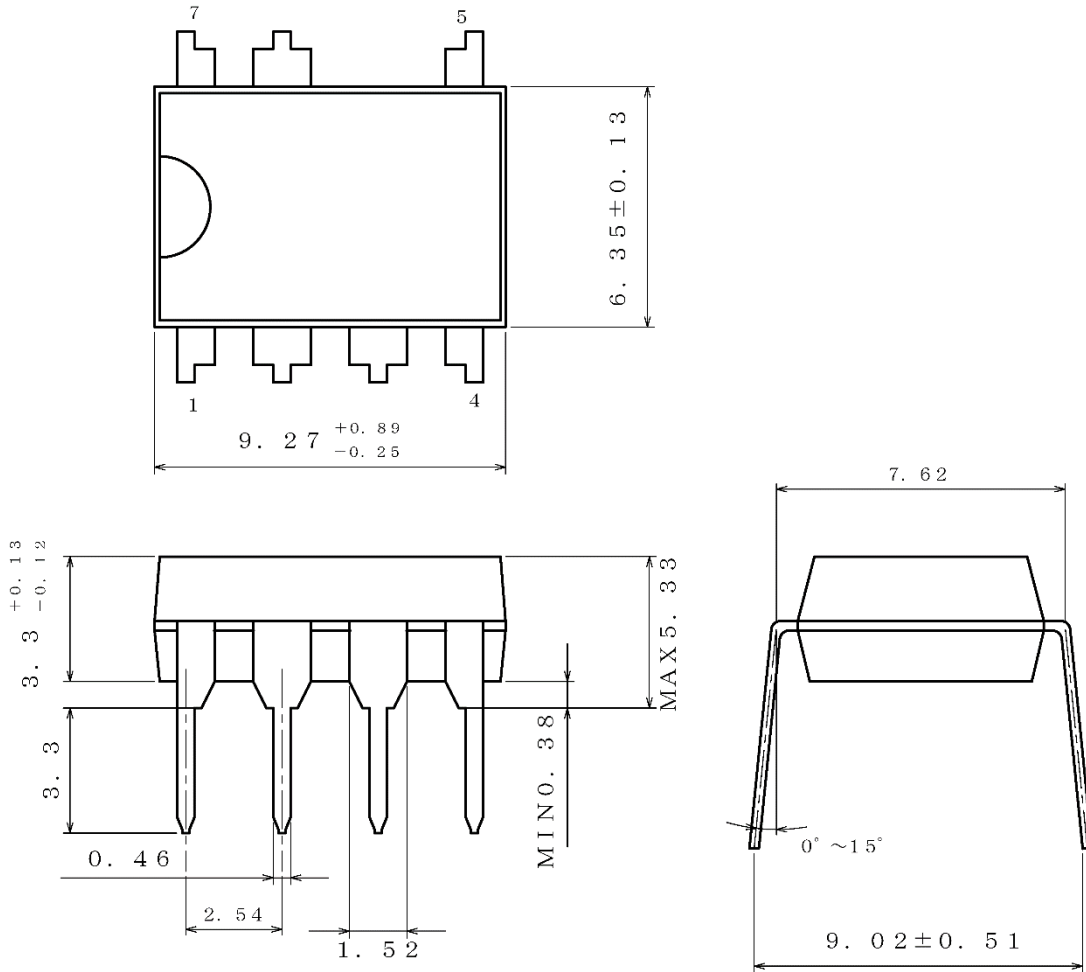

(UNIT : mm)  
 PKG : DIP7K  
 Drawing No. EX001-0076

< Container Information >

Container	Tube
Quantity	2000pcs
Direction of feed	Packing orientation is same in tube

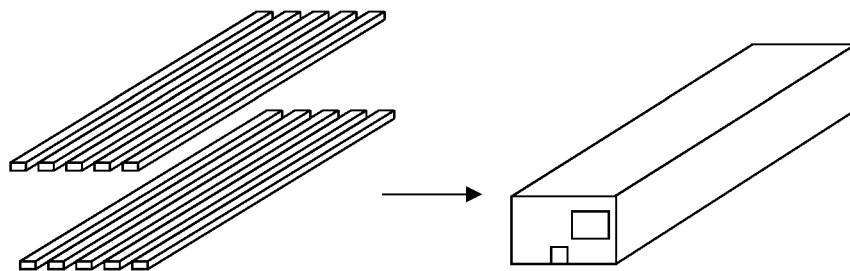

Revision History

Date	Revision	Changes
18.May.2021	001	New Release

# Notice

## Precaution on using ROHM Products

- Our Products are designed and manufactured for application in ordinary electronic equipment (such as AV equipment, OA equipment, telecommunication equipment, home electronic appliances, amusement equipment, etc.). If you intend to use our Products in devices requiring extremely high reliability (such as medical equipment <sup>(Note 1)</sup>, transport equipment, traffic equipment, aircraft/spacecraft, nuclear power controllers, fuel controllers, car equipment including car accessories, safety devices, etc.) and whose malfunction or failure may cause loss of human life, bodily injury or serious damage to property ("Specific Applications"), please consult with the ROHM sales representative in advance. Unless otherwise agreed in writing by ROHM in advance, ROHM shall not be in any way responsible or liable for any damages, expenses or losses incurred by you or third parties arising from the use of any ROHM's Products for Specific Applications.

(Note1) Medical Equipment Classification of the Specific Applications

JAPAN	USA	EU	CHINA
CLASS III	CLASS III	CLASS II b	CLASS III
CLASS IV		CLASS III	

- ROHM designs and manufactures its Products subject to strict quality control system. However, semiconductor products can fail or malfunction at a certain rate. Please be sure to implement, at your own responsibilities, adequate safety measures including but not limited to fail-safe design against the physical injury, damage to any property, which a failure or malfunction of our Products may cause. The following are examples of safety measures:
  - Installation of protection circuits or other protective devices to improve system safety
  - Installation of redundant circuits to reduce the impact of single or multiple circuit failure
- Our Products are designed and manufactured for use under standard conditions and not under any special or extraordinary environments or conditions, as exemplified below. Accordingly, ROHM shall not be in any way responsible or liable for any damages, expenses or losses arising from the use of any ROHM's Products under any special or extraordinary environments or conditions. If you intend to use our Products under any special or extraordinary environments or conditions (as exemplified below), your independent verification and confirmation of product performance, reliability, etc. prior to use, must be necessary:
  - Use of our Products in any types of liquid, including water, oils, chemicals, and organic solvents
  - Use of our Products outdoors or in places where the Products are exposed to direct sunlight or dust
  - Use of our Products in places where the Products are exposed to sea wind or corrosive gases, including Cl<sub>2</sub>, H<sub>2</sub>S, NH<sub>3</sub>, SO<sub>2</sub>, and NO<sub>2</sub>
  - Use of our Products in places where the Products are exposed to static electricity or electromagnetic waves
  - Use of our Products in proximity to heat-producing components, plastic cords, or other flammable items
  - Sealing or coating our Products with resin or other coating materials
  - Use of our Products without cleaning residue of flux (Exclude cases where no-clean type fluxes is used. However, recommend sufficiently about the residue.) ; or Washing our Products by using water or water-soluble cleaning agents for cleaning residue after soldering
  - Use of the Products in places subject to dew condensation
- The Products are not subject to radiation-proof design.
- Please verify and confirm characteristics of the final or mounted products in using the Products.
- In particular, if a transient load (a large amount of load applied in a short period of time, such as pulse, is applied, confirmation of performance characteristics after on-board mounting is strongly recommended. Avoid applying power exceeding normal rated power; exceeding the power rating under steady-state loading condition may negatively affect product performance and reliability.
- De-rate Power Dissipation depending on ambient temperature. When used in sealed area, confirm that it is the use in the range that does not exceed the maximum junction temperature.
- Confirm that operation temperature is within the specified range described in the product specification.
- ROHM shall not be in any way responsible or liable for failure induced under deviant condition from what is defined in this document.

## Precaution for Mounting / Circuit board design

- When a highly active halogenous (chlorine, bromine, etc.) flux is used, the residue of flux may negatively affect product performance and reliability.
- In principle, the reflow soldering method must be used on a surface-mount products, the flow soldering method must be used on a through hole mount products. If the flow soldering method is preferred on a surface-mount products, please consult with the ROHM representative in advance.

For details, please refer to ROHM Mounting specification

### Precautions Regarding Application Examples and External Circuits

1. If change is made to the constant of an external circuit, please allow a sufficient margin considering variations of the characteristics of the Products and external components, including transient characteristics, as well as static characteristics.
2. You agree that application notes, reference designs, and associated data and information contained in this document are presented only as guidance for Products use. Therefore, in case you use such information, you are solely responsible for it and you must exercise your own independent verification and judgment in the use of such information contained in this document. ROHM shall not be in any way responsible or liable for any damages, expenses or losses incurred by you or third parties arising from the use of such information.

### Precaution for Electrostatic

This Product is electrostatic sensitive product, which may be damaged due to electrostatic discharge. Please take proper caution in your manufacturing process and storage so that voltage exceeding the Products maximum rating will not be applied to Products. Please take special care under dry condition (e.g. Grounding of human body / equipment / solder iron, isolation from charged objects, setting of Ionizer, friction prevention and temperature / humidity control).

### Precaution for Storage / Transportation

1. Product performance and soldered connections may deteriorate if the Products are stored in the places where:
  - [a] the Products are exposed to sea winds or corrosive gases, including Cl<sub>2</sub>, H<sub>2</sub>S, NH<sub>3</sub>, SO<sub>2</sub>, and NO<sub>2</sub>
  - [b] the temperature or humidity exceeds those recommended by ROHM
  - [c] the Products are exposed to direct sunshine or condensation
  - [d] the Products are exposed to high Electrostatic
2. Even under ROHM recommended storage condition, solderability of products out of recommended storage time period may be degraded. It is strongly recommended to confirm solderability before using Products of which storage time is exceeding the recommended storage time period.
3. Store / transport cartons in the correct direction, which is indicated on a carton with a symbol. Otherwise bent leads may occur due to excessive stress applied when dropping of a carton.
4. Use Products within the specified time after opening a humidity barrier bag. Baking is required before using Products of which storage time is exceeding the recommended storage time period.

### Precaution for Product Label

A two-dimensional barcode printed on ROHM Products label is for ROHM's internal use only.

### Precaution for Disposition

When disposing Products please dispose them properly using an authorized industry waste company.

### Precaution for Foreign Exchange and Foreign Trade act

Since concerned goods might be fallen under listed items of export control prescribed by Foreign exchange and Foreign trade act, please consult with ROHM in case of export.

### Precaution Regarding Intellectual Property Rights

1. All information and data including but not limited to application example contained in this document is for reference only. ROHM does not warrant that foregoing information or data will not infringe any intellectual property rights or any other rights of any third party regarding such information or data.
2. ROHM shall not have any obligations where the claims, actions or demands arising from the combination of the Products with other articles such as components, circuits, systems or external equipment (including software).
3. No license, expressly or implied, is granted hereby under any intellectual property rights or other rights of ROHM or any third parties with respect to the Products or the information contained in this document. Provided, however, that ROHM will not assert its intellectual property rights or other rights against you or your customers to the extent necessary to manufacture or sell products containing the Products, subject to the terms and conditions herein.

### Other Precaution

1. This document may not be reprinted or reproduced, in whole or in part, without prior written consent of ROHM.
2. The Products may not be disassembled, converted, modified, reproduced or otherwise changed without prior written consent of ROHM.
3. In no event shall you use in any way whatsoever the Products and the related technical information contained in the Products or this document for any military purposes, including but not limited to, the development of mass-destruction weapons.
4. The proper names of companies or products described in this document are trademarks or registered trademarks of ROHM, its affiliated companies or third parties.

**General Precaution**

1. Before you use our Products, you are requested to carefully read this document and fully understand its contents. ROHM shall not be in any way responsible or liable for failure, malfunction or accident arising from the use of any ROHM's Products against warning, caution or note contained in this document.
2. All information contained in this document is current as of the issuing date and subject to change without any prior notice. Before purchasing or using ROHM's Products, please confirm the latest information with a ROHM sales representative.
3. The information contained in this document is provided on an "as is" basis and ROHM does not warrant that all information contained in this document is accurate and/or error-free. ROHM shall not be in any way responsible or liable for any damages, expenses or losses incurred by you or third parties resulting from inaccuracy or errors of or concerning such information.