

Design Example Report

Title	<i>60 W Power Supply Using InnoSwitch™3-CP PowiGaN™ INN3270C-H203</i>
Specification	100 VAC – 132 VAC Input; 5 V / 6.5 A, 9 V / 5 A, 15 V / 3 A, 20 V / 3 A Outputs
Application	USB Wall Outlet, Power Strip with USB Charging Ports
Author	Applications Engineering Department
Document Number	DER-917
Date	July 20, 2022
Revision	1.1

Summary and Features

- 60 W low profile compact power supply for high power USB Type-A/C port charging
- >94% Full Load Efficiency at nominal Input
- Component temperatures <100 °C with up to 50 °C ambient temperature operation
- <40 mW system no-load input power
- PowiGaN-based InnoSwitch3-CP benefits
 - Highly integrated switcher IC with integrated high-voltage MOSFET, synchronous rectification and FluxLink™ feedback
 - GAN-based Integrated MOSFET enables heat sink-less design
 - Fast instantaneous transient response with 0%-100%-0% load step
 - Constant Power (CP) profile minimizes charging time with continuous adjustment of output current and voltage
- Low components count (40 pcs)
- Easily meets DOE6 efficiency requirements
- Integrated protection and reliability features
 - Output short-circuit protection
 - OVP, OCP and OTP protection
- Meets 2.0 kV differential surge and EN55022 conducted EMI

Power Integrations

5245 Hellyer Avenue, San Jose, CA 95138 USA.
Tel: +1 408 414 9200 Fax: +1 408 414 9201
www.power.com

PATENT INFORMATION

The products and applications illustrated herein (including transformer construction and circuits external to the products) may be covered by one or more U.S. and foreign patents, or potentially by pending U.S. and foreign patent applications assigned to Power Integrations. A complete list of Power Integrations' patents may be found at www.power.com. Power Integrations grants its customers a license under certain patent rights as set forth at <https://www.power.com/company/intellectual-property-licensing/>.



Table of Contents

1	Introduction.....	6
2	Power Supply Specification.....	8
3	Schematic.....	9
4	Circuit Description	10
4.1	Input EMI Filter and Rectifier	10
4.2	InnoSwitch3-CP Primary-Side Control	10
4.3	InnoSwitch3-CP Secondary-Side Control	11
5	PCB Layout.....	12
6	Bill of Materials	13
6.1	Electrical Parts.....	13
6.2	Mechanical Parts.....	13
7	Power Transformer Specification (T1)	14
7.1	Electrical Diagram.....	14
7.2	Electrical Specifications	14
7.3	Material List	15
7.4	Transformer Build Diagram.....	15
7.5	Winding Illustrations	16
8	Transformer (T1) Spreadsheet	23
9	Performance Data	27
9.1	System Full Load Efficiency.....	28
9.2	Energy Efficiency	29
9.2.1	System Average Efficiency	29
9.2.2	Efficiency at 10% Load	30
9.3	Efficiency vs. Load	31
9.4	No-Load Input Power	35
9.5	Output Voltage Load Regulation.....	36
9.6	VI Characteristic Curve.....	40
9.7	Test Data.....	44
9.7.1	Electrical Test Data at Full Load.....	44
9.7.2	Energy Efficiency Test Data.....	45
9.7.3	Electrical Test Data at 20 V / 3 A.....	46
9.7.4	Electrical Test Data at 15 V / 3 A.....	47
9.7.5	Electrical Test Data at 9 V / 5 A.....	48
9.7.6	Electrical Test Data at 5 V / 6.5 A.....	49
9.8	Output Ripple Voltage	50
9.8.1	Output Ripple Voltage vs. Load at 100 VAC.	51
9.8.2	Output Ripple Voltage vs. Load at 132 VAC	52
10	Thermal Performance.....	53
10.1	Thermal Scan at 25 °C Ambient.....	53
10.1.1	Thermal Scan Summary.....	53
10.1.2	100 VAC Input 20 V / 3 A	54
10.1.3	132 VAC Input 20 V / 3 A	55
10.1.4	100 VAC Input 15 V / 3 A	56



10.1.5	132 VAC Input 15 V / 3 A	57
10.1.6	100 VAC Input 9 V / 5 A	58
10.1.7	132 VAC Input 9 V / 5 A	59
10.1.8	100 VAC Input 5 V / 6.5 A	60
10.1.9	132 VAC Input 5 V / 6.5 A	61
10.2	Thermal Performance at 50 °C Ambient	62
10.2.1	Set-up Picture.....	62
10.2.2	Thermal Test Summary at 50 °C Ambient	62
10.2.3	Thermal Data at 50 °C Ambient	63
11	Waveforms.....	69
11.1	Primary Drain Voltage and Current Waveform	69
11.2	SR FET Drain Voltage Waveform.....	71
11.3	Start-up Profile.....	72
11.4	Transient Load Response	74
11.4.1	Transient Load at $V_{OUT} = 20$ V	74
11.4.2	Transient Load at $V_{OUT} = 15$ V	74
11.4.3	Transient Load at $V_{OUT} = 9$ V.....	75
11.4.4	Transient Load at $V_{OUT} = 5$ V.....	75
11.5	Output Ripple Voltage Waveforms.....	76
11.5.1	Output Ripple Voltage at $V_{OUT} = 20$ VDC / 3 A	76
11.5.2	Output Ripple Voltage at $V_{OUT} = 15$ VDC / 3 A	76
11.5.3	Output Ripple Voltage at $V_{OUT} = 9$ VDC / 3 A	77
11.5.4	Output Ripple Voltage at $V_{OUT} = 5$ VDC / 3 A	77
11.6	Output Short-Circuit.....	78
11.6.1	Output Short-Circuit	78
11.6.2	Start Up with Output Shorted.....	79
12	Conducted EMI.....	80
12.1	Test Set-up.....	80
12.2	Equipment and Load Used.....	80
12.3	Conducted EMI at $V_{OUT} = 20$ V Full Load with Output Floating	81
12.3.1	Output Load: 6.7Ω (20 V / 3 A) fixed resistor	81
12.4	Conducted EMI at $V_{OUT} = 15$ V Full Load with Output Floating	82
12.4.1	Output Load: 5Ω (15 V / 3 A) fixed resistor	82
12.5	Conducted EMI at $V_{OUT} = 9$ V Full Load with Output Floating	83
12.5.1	Output Load: 1.8Ω (9 V / 5 A) fixed resistor	83
12.6	Conducted EMI at $V_{OUT} = 5$ V Full Load with Output Floating	84
12.6.1	Output Load: 0.78Ω (5 V / 6.5 A) fixed resistor	84
13	Line Immunity	85
13.1	Differential Surge Test Results.....	85
13.2	Ring Wave Surge Test Results	86
14	ESD	87
14.1	ESD Discharge at the End of the Output Cable	87
15	Brown-Out / Brown-Out Recovery Test	88
16	Revision History.....	89



Important Note: Although this board is designed to satisfy safety isolation requirements, the engineering prototype has not been agency approved. Therefore, all testing should be performed using an isolation transformer to provide the AC input to the prototype board.



1 Introduction

This engineering report describes an off-line 60 W isolated flyback power supply designed to operate at an input voltage range from 100 VAC to 132 VAC within its 4 selectable output ranges (20 V / 3 A, 15 V / 3 A, 9 V / 5 A and 5 V / 6.5 A). The power supply circuitry is controlled by InnoSwitch3-CP PowiGaN INN3370C-H203.

PowiGaN InnoSwitch3-CP ICs are low profile, highly integrated, quasi-resonant flyback switcher ICs with constant power regulation profile that is essential for fast charging applications. It integrates a high-voltage switch, primary and secondary-side control and FluxLink feedback which dramatically simplifies the development of isolated flyback power supply, particularly those in compact enclosures.

DER-917 offers a high low-line efficiency, low component count and heat sink-less design to meet increasing demands for power savings and small form factor enclosures.

The document contains the power supply specification, schematic, bill of materials, transformer documentation, printed circuit layout, design spreadsheet, and performance data.

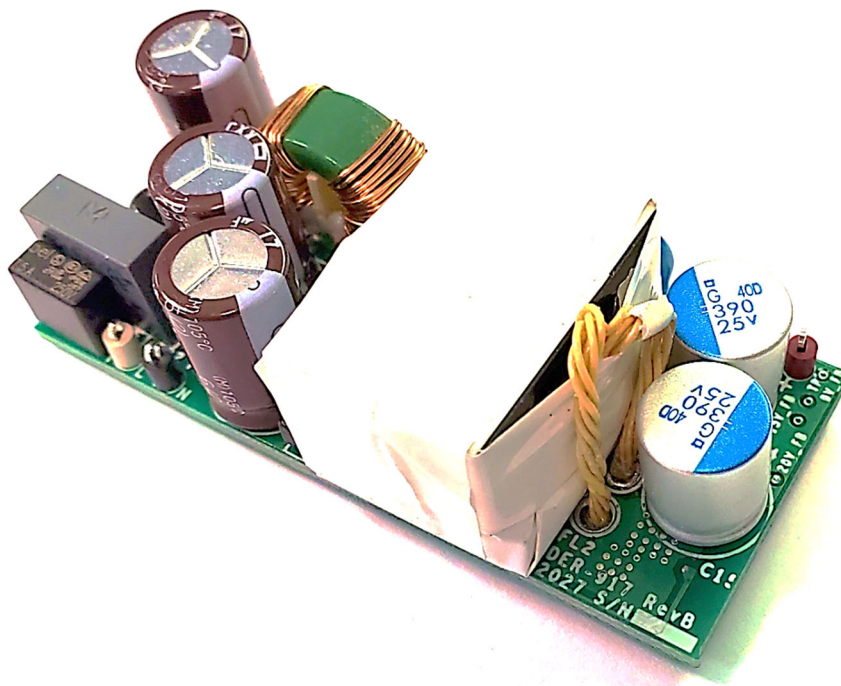

Figure 1 – Populated Circuit Board.

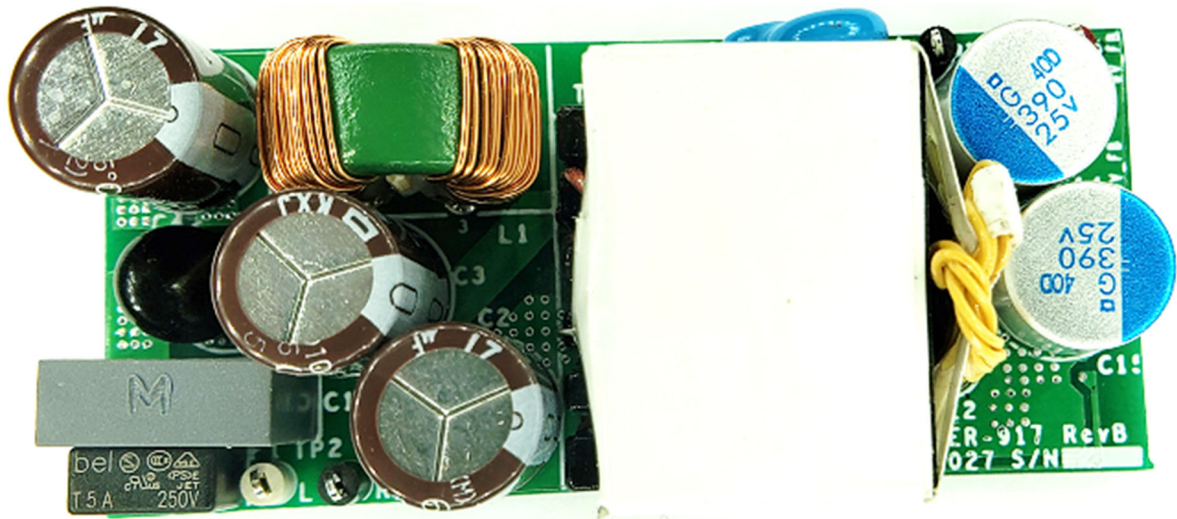

Figure 2 – Populated Circuit Board, Top View.

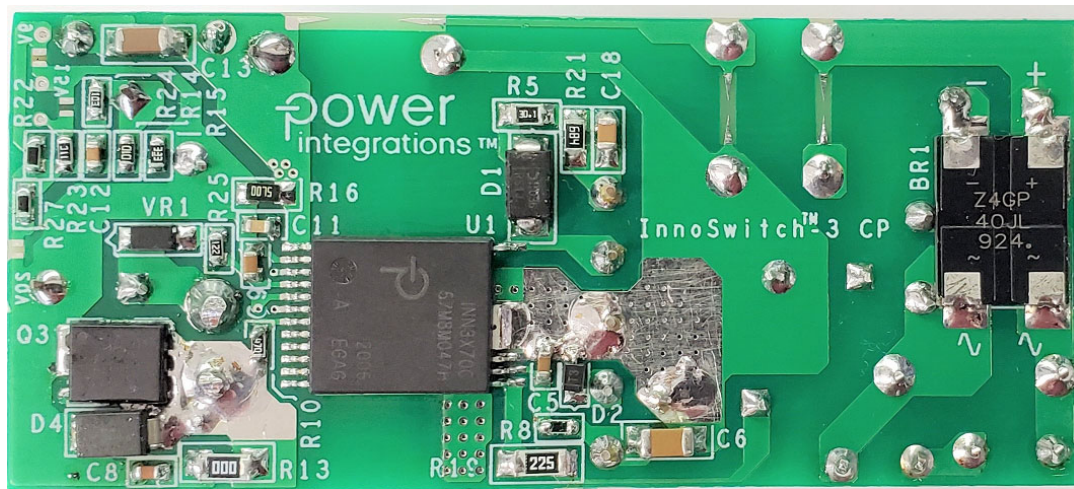

Figure 3 – Populated Circuit Board, Bottom View.

2 Power Supply Specification

The table below represents the minimum acceptable performance of the design. Actual performance is listed in the results section.

Description	Symbol	Min	Typ	Max	Units	Comment
Input						
Voltage	V_{IN}	100	115	132	VAC	2 Wire – no P.E.
Frequency	f_{LINE}	47	60	63	Hz	
No-load Input Power (115 VAC)			40		mW	Measured at 115 VAC, 5V Output
5 V Output						
Output Voltage	V_{OUT}		5		V	$\pm 3\%$
Output Ripple Voltage	V_{RIPPLE}			150	mV	At End of Cable. Cable Needs a Resistance of 100 m Ω .
Output Current	I_{OUT}			6.5	A	20 MHz Bandwidth.
Efficiency	η		91		%	Measured at 115 VAC.
9 V Output						
Output Voltage	V_{OUT}		9		V	$\pm 5\%$
Output Ripple Voltage	V_{RIPPLE}			150	mV	At End of Cable. Cable Needs a Resistance of 100 m Ω .
Output Current	I_{OUT}			5	A	20 MHz Bandwidth.
Efficiency	η		93		%	Measured at 115 VAC.
15 V Output						
Output Voltage	V_{OUT}		15		V	$\pm 5\%$
Output Ripple Voltage	V_{RIPPLE}			150	mV	At End of Cable. Cable Needs a Resistance of 100 m Ω .
Output Current	I_{OUT}			3	A	20 MHz Bandwidth.
Efficiency	η		94		%	Measured at 115 VAC.
20 V Output						
Output Voltage	V_{OUT}		20		V	$\pm 5\%$
Output Ripple Voltage	V_{RIPPLE}			200	mV	At End of Cable. Cable Needs a Resistance of 100 m Ω .
Output Current	I_{OUT}			3	A	20 MHz Bandwidth.
Efficiency	η		94		%	Measured at 115 VAC.

For extended output load requirement at 15 V and 9 V output.

9 V Output						
Output Voltage	V_{OUT}		9		V	$\pm 5\%$
Output Ripple Voltage	V_{RIPPLE}			200	mV	At End of Cable. Cable Needs a Resistance of 100 m Ω .
Output Current	I_{OUT}			6	A	20 MHz Bandwidth.
Efficiency	η		92		%	Measured at 115 VAC.
15 V Output						
Output Voltage	V_{OUT}		15		V	$\pm 5\%$
Output Ripple Voltage	V_{RIPPLE}			200	mV	At End of Cable. Cable Needs a Resistance of 100 m Ω .
Output Current	I_{OUT}			4	A	20 MHz Bandwidth.
Efficiency	η		93		%	Measured at 115 VAC.



3 Schematic

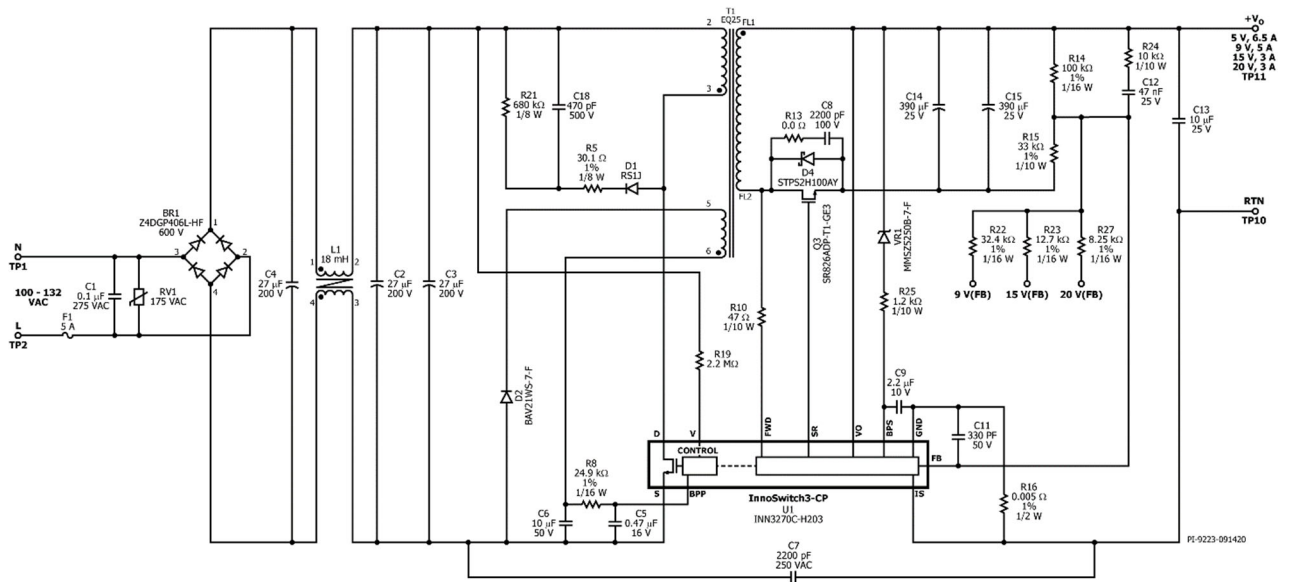

Figure 4 – Main Board Schematic.

4 Circuit Description

The circuit is an isolated quasi-resonant flyback power supply with synchronous rectification controlled by a PowiGaN InnoSwitch3-CP controller IC. The IC incorporates primary-side controller, secondary-side controller and FluxLink feedback along with a high-voltage PowiGaN power MOSFET in one single package. Please see the product data sheet for more details on the functional descriptions.

4.1 *Input EMI Filter and Rectifier*

The input fuse (F1) provides safety protection from component failures. Metal oxide varistor (RV1) help prevents component failure in the event of high-voltage input line surge. The AC input voltage is full wave rectified by the bridge rectifier (BR1) and then filtered by the bulk capacitors (C4, C2 and C3) to provide a smooth DC input voltage supply to the flyback circuitry. Input common mode choke (L1) is connected between C4 and C2 to provide common mode noise filtering and at the same time forms an LC filter circuit with its leakage inductance for differential mode noise filtering. A low ESR electrolytic capacitor is recommended for the bulk capacitors (C4, C2 and C3) for better differential mode noise filtering and higher efficiency. Y capacitor (C7) bypass common mode noise back to the primary power ground. X capacitor (C1) helps reduce the differential mode EMI noise.

4.2 *InnoSwitch3-CP Primary-Side Control*

The power transformer (T1) is designed for flyback power conversion. For a better EMI shielding, the primary winding start terminal (pin 3) must be connected to the noisy DRAIN pin of the power MOSFET inside the InnoSwitch3-CP IC and the finish terminal (pin 2) is connected to the positive terminal of the bulk capacitor (C1). RCD snubber (D1, R5, R21 and C18) cut down leakage voltage spike and help minimize the voltage stress across the primary MOSFET internal to the IC. Fast recovery diode is recommended for D1 and RC values must be optimized to achieved better efficiency and standby power.

The InnoSwitch3-CP internal bypass regulator charge the PRIMARY BYPASS (BPP) pin decoupling capacitor (C5) when AC is first applied. The BPP pin capacitor (C5) allows the user to program the current limit (I_{LIM}) setting through the selection of capacitance value (0.47 μ F and 4.7 μ F for standard and increased I_{LIM} settings respectively). In this design, 0.47 μ F (Standard I_{LIM}) was selected for a lower RMS current on primary drain. During normal operation, the primary-side of the IC is powered from the auxiliary winding of transformer (T1). The auxiliary winding voltage is rectified using bias diode (D2) and filtered by the bias capacitor (C4). An RC filter network might be needed to minimize radiated EMI noise.

The V pin resistor (R19) is connected between high-voltage positive bulk capacitor (C2 and C3) and V pin terminal for input line voltage monitoring. The input line voltage is checked to confirm that it is above the brown-in and below the overvoltage shutdown thresholds.

4.3 ***InnoSwitch3-CP Secondary-Side Control***

The secondary winding start terminal (FL1) of the transformer (T1) is connected to the positive terminal of output capacitor C14 and C15 while the finish terminal is connected to the DRAIN pin of the SR FET (Q3). The secondary winding voltage is rectified by the SR FET (Q3) in a quasi-resonant mode switching and then filtered by the output capacitors C14 and C15. Leakage voltage spike and ringing across SR FET drain to source during off time is minimize by the secondary RC snubber (R13 and C18). For high efficiency requirement, shorting R13 will help improve the efficiency. Schottky diode (D4) helps improve full load efficiency specially at 5 V output.

The secondary-side circuitry of the IC is self-powered by the internal regulator which is supplied by either the secondary winding forward voltage (through FW pin) or by the output voltage (through VO pin). Secondary bypass capacitor (C14) connected across the BPS pin and GND pin serves as decoupling capacitor for the 4.4 V internal linear regulator to maintain a smooth DC supply voltage. When the output voltage (VO) falls during constant current mode operation, the secondary-side internal regulator will be supplied by the secondary winding forward voltage through FORWARD (FWD) pin resistor (R10). This will maintain the output current regulation down to the minimum BPS pin auto-restart voltage threshold. Below this level the unit enters auto-restart until the output load is reduced. A 47 Ω resistor is recommended for FWD pin resistor (R10) to ensure sufficient IC supply current.

The forward voltage sensed by FWD pin from secondary winding is also use for both handshaking and quasi-resonant timing for the SR FET (Q3), which is driven by the SYNCHRONOUS RECTIFIER DRIVE (SR) pin. The FWD pin voltage is use to determine when to turn off the SR FET in discontinuous conduction mode operation. This is when the voltage across the $R_{DS(ON)}$ of the SR FET (Q3) drops below zero volts with respect to the GND pin. In continuous conduction mode (CCM) the SR FET is turned off when the feedback pulse is sent to the primary to demand the next switching cycle, providing excellent synchronous operation, free of any overlap for the SR FET turn-off.

Output current is sensed by monitoring the voltage drop across resistor R16 between the IS and SECONDARY GROUND pins. The internal constant current sense threshold is approximately 32 mV. Once the internal current sense threshold is exceeded, the device regulates the number of switch pulses to maintain a fixed output current.

Below the CC threshold, the device operates in constant voltage mode. The external resistor divider network (R14 and R15) is use for output voltage sensing to regulate the output voltage. The rest of the lower voltage divider resistors (R22, R23 and R27) are used to set output voltage from 5 V to 9 V, 15 V and 20 V respectively. The internal voltage comparator reference voltage is V_{FB} (1.265 V). A phase boost RC network (R24 and C12) is added to optimize ripple voltage.

5 PCB Layout

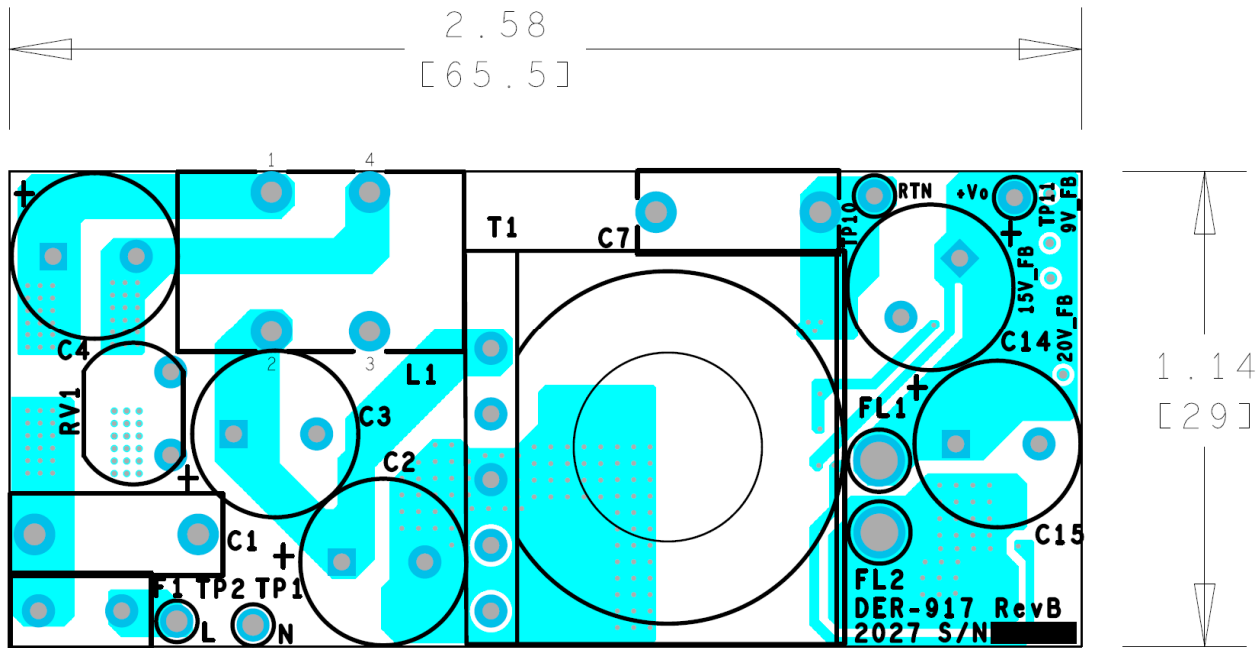

Figure 5 – Top Side.

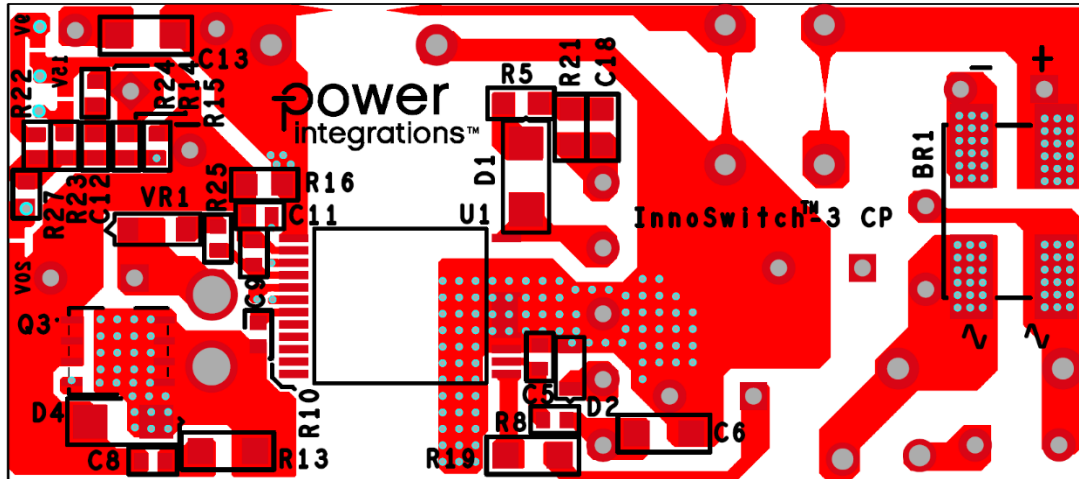

Figure 6 – Bottom Side.

6 Bill of Materials

6.1 Electrical Parts

Item	Qty	Ref Des	Description	Mfg Part Number	Mfg
1	1	BR1	RECT BRIDGE, GP, 600 V, 4 A, Z4-D, -55°C ~ 175°C (TJ)	Z4DGP406L-HF	Comchip
2	1	C1	0.1 μ F, 20%, 275 VAC, 560 VDC, X2, -40°C	R46KF3100DQP1M	KEMET
3	3	C2 C3 C4	27 μ F, 200 V, Electrolytic, (10 x 16),	EKXJ201ELL270MJ16S	Nippon Chemi-Con
4	1	C5	0.47 μ F, 10%, 16V, X7R, 0603	GRM188R71C474KA88D	Murata
5	1	C6	10 μ F, 10%, 50 V, Ceramic, X7R, -55°C ~ 125°C, 1206	CL31B106KBHNNNE	Samsung
6	1	C7	2200 pF, \pm 20%, 250 VAC, X1, Y1,	DE1E3KX222MN4AN01F	Murata
7	1	C8	2200 pF, \pm 10%, 100V, Ceramic, X7R, 0603	C0603C222K1RACTU	KEMET
8	1	C9	2.2 μ F, 10 V, Ceramic, X7R, 0603	GRM188R71A225KE15D	Murata
9	1	C11	330 pF 50 V, Ceramic, X7R, 0603	CC0603KRX7R9BB331	Yageo
10	1	C12	47 nF 25 V, Ceramic, X7R, 0603	CC0603KRX7R8BB473	Yago
11	1	C13	10 μ F, 25 V, Ceramic, X7R, 1206	C3216X7R1E106M160AB	TDK
12	2	C14 C15	390 μ F, 25 V, Al Organic Polymer, Gen. Purpose	APSG250ELL391MJB5S	United Chemi-con
13	1	C18	470 pF, \pm 10%, 500 V, Ceramic, X7R, 0805	C0805C471KCRCTU	Kemet
14	1	D1	600 V, 1 A, Fast Recovery, 250 ns, SMA	RS1J-13-F	Diodes, Inc.
15	1	D2	250 V, 0.2 A, Fast Switching, 50 ns, SOD-323	BAV21WS-7-F	Diodes, Inc.
16	1	D4	100 V, 2 A, Schottky, SMA	STPS2H100AY	ST Micro
17	1	F1	5 A, 250 V, Slow, Long Time Lag, RST	RST 5	Belfuse
18	1	L1	Custom, CMC, 18mH @ 10 kHz, Toroidal	04291-T231	Sumida
19	1	Q3	80 V, 60 A, N-Channel, PowerPAK SO-8	SIR826ADP-T1-GE3	Vishay
20	1	R5	RES, 30.1 Ω , 1%, 1/8 W, Thick Film, 0805	ERJ-6ENF30R1V	Panasonic
21	1	R8	RES, 24.9 k Ω , 1%, 1/16 W, Thick Film, 0603	ERJ-3EKF2492V	Panasonic
22	1	R10	RES, 47 Ω , 5%, 1/10 W, Thick Film, 0603	ERJ-3GEYJ470V	Panasonic
23	1	R13	RES, 0 Ω , 5%, 1/4 W, Thick Film, 1206	ERJ-8GEY0R00V	Panasonic
24	1	R14	RES, 100 k Ω , 1%, 1/16 W, Thick Film, 0603	ERJ-3EKF1003V	Panasonic
25	1	R15	RES, SMD, 33 k Ω , 1%, 1/10W, \pm 100ppm/ $^{\circ}$ C, 0603	RC0603FR-0733KL	Yageo
26	1	R16	RES, 0.005 Ω , \pm 1%, 0.5W, 1/2W, 0805	ERJ-6LWFR005V	Panasonic
27	1	R19	RES, 2.2 M Ω , 5%, 1/4 W, Thick Film, 1206	ERJ-8GEYJ225V	Panasonic
28	1	R21	RES, 680 k Ω , 5%, 1/8 W, Thick Film, 0805	ERJ-6GEYJ684V	Panasonic
29	1	R22	RES, 32.4 k Ω , 1%, 1/16 W, Thick Film, 0603	ERJ-3EKF3242V	Panasonic
30	1	R23	RES, 12.7 k Ω , 1%, 1/16 W, Thick Film, 0603	ERJ-3EKF1272V	Panasonic
31	1	R24	RES, 10 k Ω , 5%, 1/10 W, Thick Film, 0603	ERJ-3GEYJ103V	Panasonic
32	1	R25	RES, 1.2 k Ω , 5%, 1/10 W, Thick Film, 0603	ERJ-3GEYJ122V	Panasonic
33	1	R27	RES, 8.25 k Ω , 1%, 1/16 W, Thick Film, 0603	ERJ-3EKF8251V	Panasonic
34	1	RV1	175 VAC, 17 J, 7 mm, RADIAL	ERZ-V07D271	Panasonic
35	1	T1	Bobbin, EQ25, 6 pins, 6pri, 0sec Transformer	POT-2501 POL-INN054	Shenzhen xin yu jia Premier Magnetics
36	1	U1	InnoSwitch3-CP, InSOP24D	INN3270C-H203	Power Integrations
37	1	VR1	DIODE ZENER 20 V 500 MW SOD123	MMSZ5250B-7-F	Diodes, Inc.

6.2 Mechanical Parts

Item	Qty	Ref Des	Description	Mfg Part Number	Mfg
1	2	TP1 TP10	Test Point, BLK, Miniature THRU-HOLE MOUNT	5001	Keystone
2	1	TP2	Test Point, WHT, Miniature THRU-HOLE MOUNT	5002	Keystone
3	1	TP11	Test Point, RED, Miniature THRU-HOLE MOUNT	5000	Keystone



7 Power Transformer Specification (T1)

7.1 Electrical Diagram

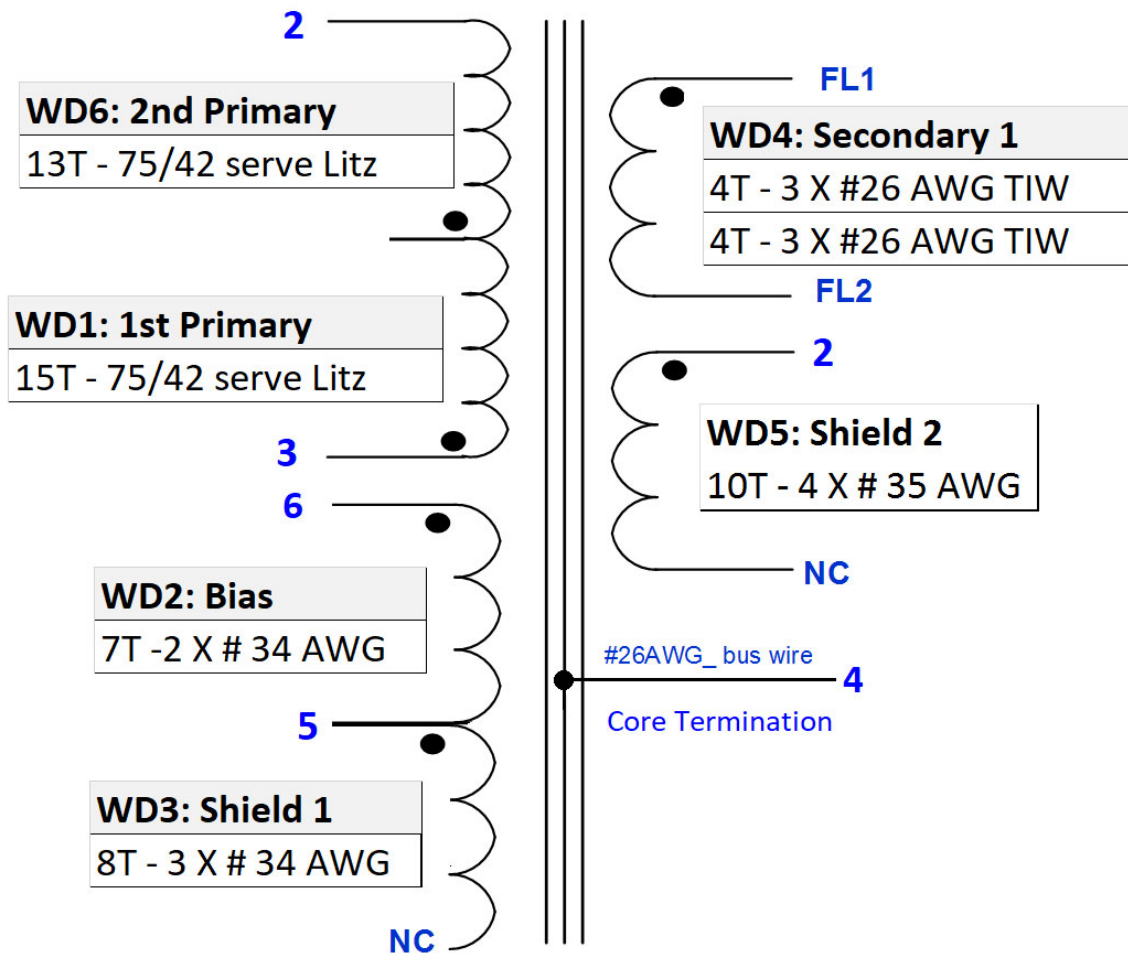

Figure 7 – Transformer Electrical Diagram.

7.2 Electrical Specifications

Parameter	Condition	Spec.
Nominal Primary Inductance	Measured at 1 V _{PK-PK} , 100 kHz switching frequency, between pin 2 and 3, with all other windings open.	400 μH ±5%
Resonant Frequency	Between pin 2 and 3, other windings open.	1,000 kHz (Min.)
Primary Leakage Inductance	Between pin 2 and 3, with pins:FL1-FL2 shorted.	< 6 μH (Max.)

7.3 **Material List**

Item	Description
[1]	Core: EQ25, Ferroxcube: 3C95.
[2]	Bobbin: EQ25-Vert-6pins (6/0); PI#: 25-01136-00.
[3]	Magnet Wire: Served Litz 75/42.
[4]	Magnet Wire: #34 AWG, Double Coated.
[5]	Magnet Wire: #35 AWG, Double Coated.
[6]	Magnet Wire: #26 AWG, Triple Insulated Wire.
[7]	Bus Wire: #26 AWG, Alpha Wire, Tinned Copper.
[8]	Tape: 3M 13450-F, Polyester Film, 1 mil Thickness, 7.5 mm Width.
[9]	Tape: 3M 13450-F, Polyester Film, 1 mil Thickness, 18.2 mm.
[10]	Varnish: Dolph BC-359.

7.4 **Transformer Build Diagram**

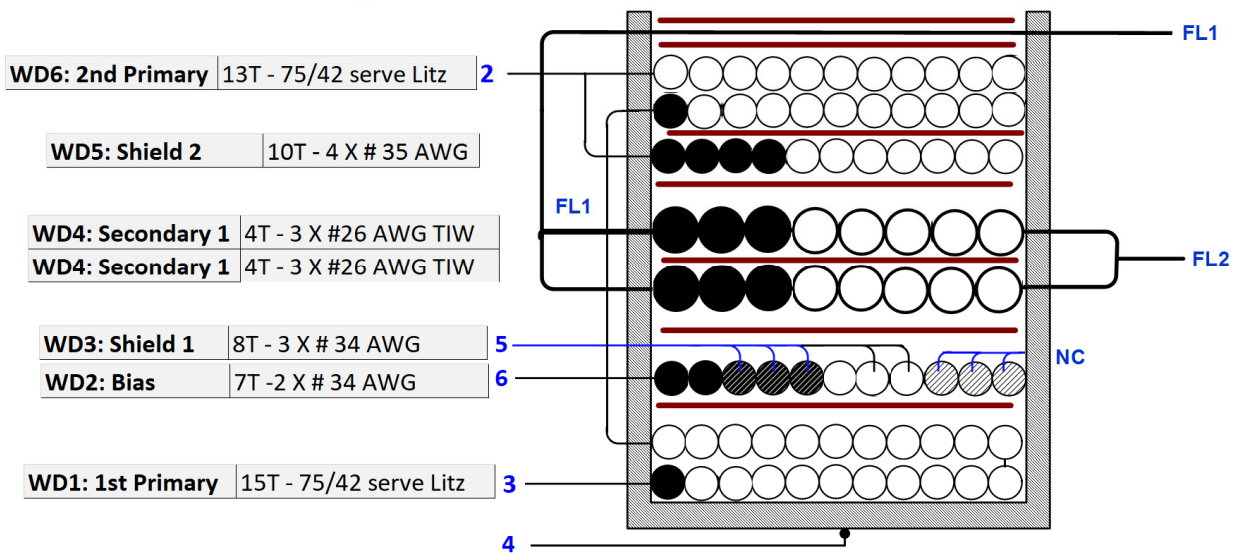
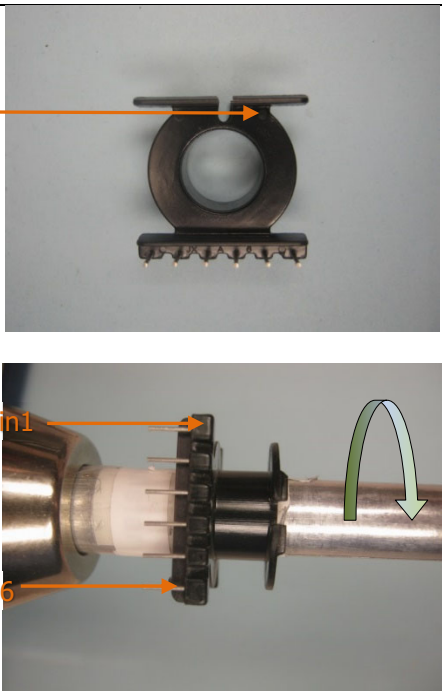
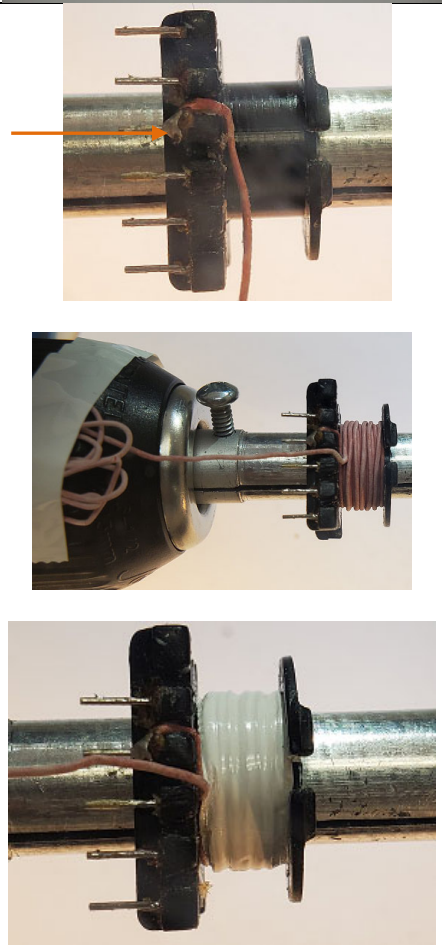

Figure 8 – Transformer Build Diagram.

7.5 **Winding Illustrations**

<p>Bobbin Preparation Make slots with 2.0 mm width on both flanges of secondary-side of bobbin Item [2]. Position the bobbin Item [2] on the mandrel such that the primary-side of the bobbin is on the left side. Winding direction is clock-wise direction for forward direction.</p> <p>Winding Directions Bobbin is oriented on winder jig such that terminal Pin 1- 6 are in the left side facing upward. The winding direction is clockwise.</p>	
<p>Winding 1- 1st Primary Use a 75/42 Litz wire, Item [3]. Start at Pin 3 and wind 15 turns evenly in 2 layers.</p> <p>Set aside an extension on the left side of the bobbin long enough for 13 turns (Winding 6).</p> <p>Apply 1 layer of polyester tape, Item [8] for insulation</p>	

Winding 2 and 3 – Bias and shield 1

Use magnetic wire, Item [4] - AWG#34 for winding 2 and 3. Prepare bifilar wire for winding 2 and three (trifilar) wires for winding 3. For Winding 2, start at pin 6 while for winding 3, start at pin 5.

Wind winding 2 and 3 evenly together for 7 turns from left to right.

For winding 2, Finish the winding back to the left on Pin 5.

For winding 3, add 1 more turn to make it 8 turns and cut the finish terminal as shown in the figure.

Apply 1 layer of polyester tape, Item [8] for insulation

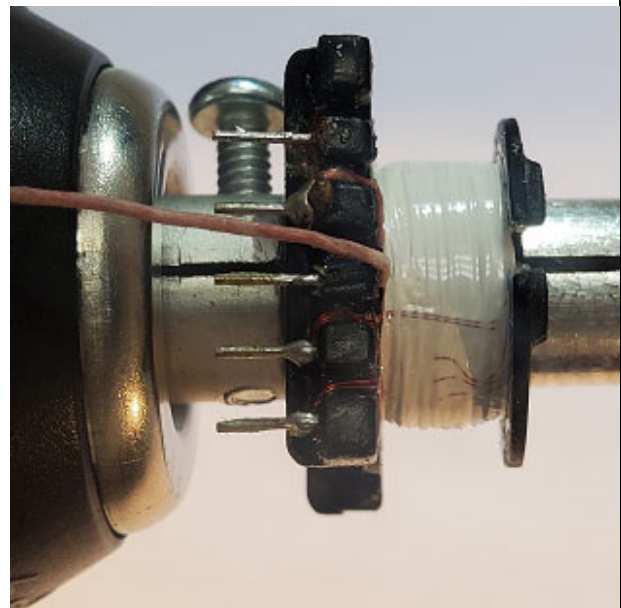
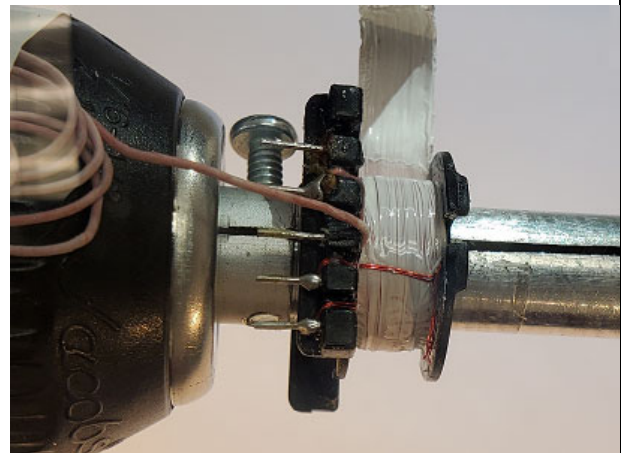
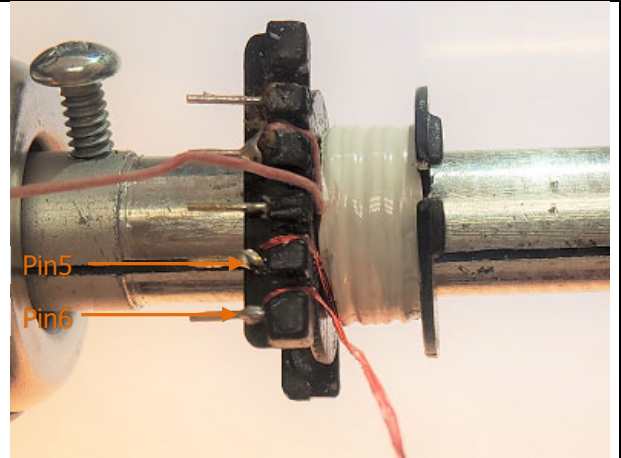

Winding 4- Secondary Winding

Position the bobbin on the other side with the secondary wire slot facing upward. Use TIW wire Item [6] – AWG#26.

First Layer - Prepare 3 (trifilar) wires and secure 70 mm fly lead (FL1) extension on the left side. Wind 4 turns evenly from left to right. Fix the finish fly lead terminal (FL2) on the right side of the jig and cut with around 70mm wire extension

Apply 1 layer of polyester tape, Item [8] for insulation

Second Layer – Same with the first layer, prepare 3 (trifilar) wires and secure 70 mm fly lead (FL1) extension on the left side. Wind 4 turns evenly from left to right. Fix the finish fly lead terminal (FL2) on the right side of the jig and cut with around 70mm wire extension.

Combine fly lead wires from first and second layer and add polarity marking.

Apply 1 layer of polyester tape, Item [8] for insulation

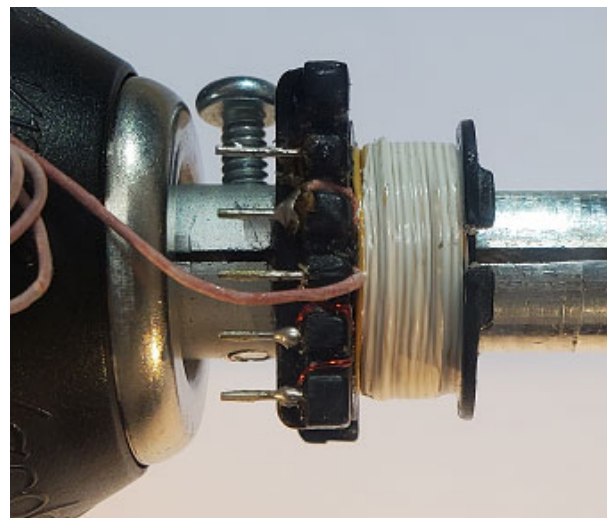
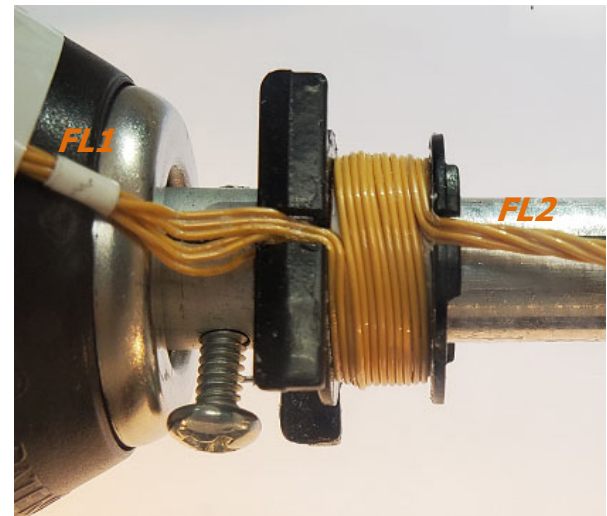
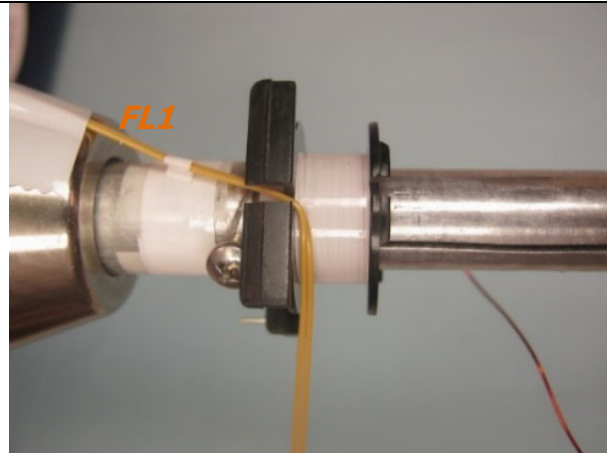

Winding 5- Shield 2

Use magnetic wire, Item 5 - AWG#35. Prepare 4 wires (quadrifilar). Start at Pin 2 and wind 10 turns evenly from left to right for 1 layer.

Finish the winding at the right side of the bobbin and cut the wire as shown in the figure.

Apply 1 layer of polyester tape, Item [8] for insulation

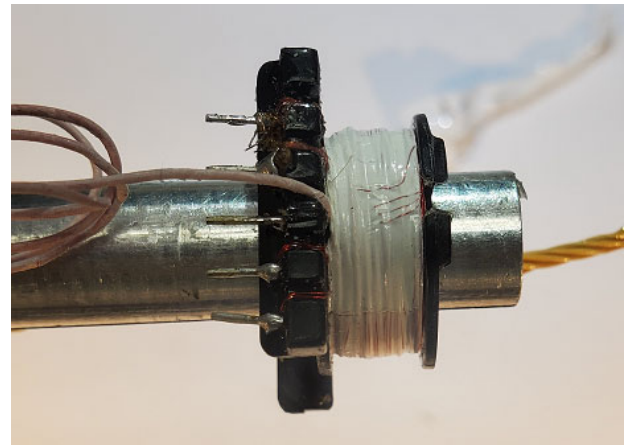
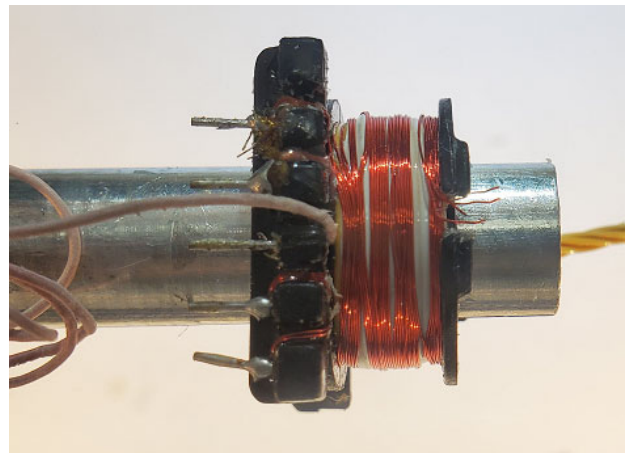
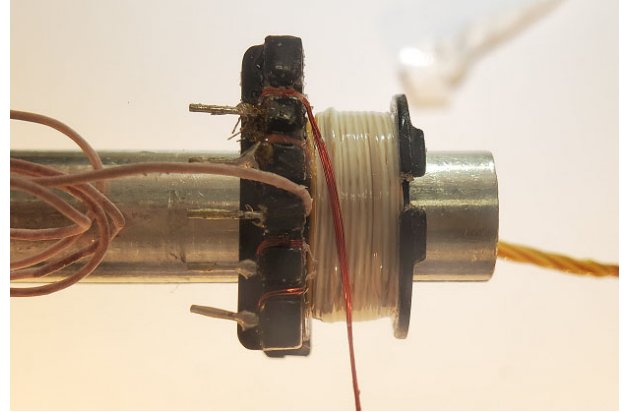

Winding 6- 2nd Primary

Use the remaining wires set aside from winding 1. Start at the middle of the bobbin and wind 13 turns evenly for 2 layers. Finish the winding on Pin 2

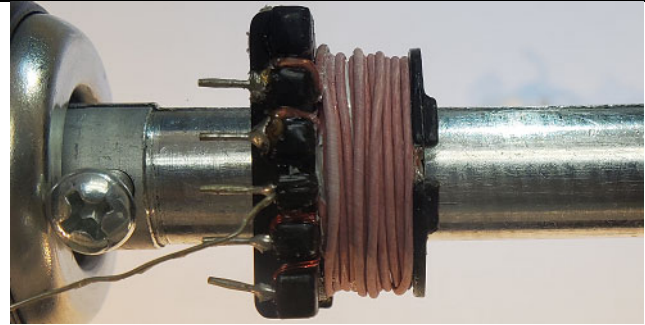

Apply 1 layer of polyester tape, Item [8] for insulation

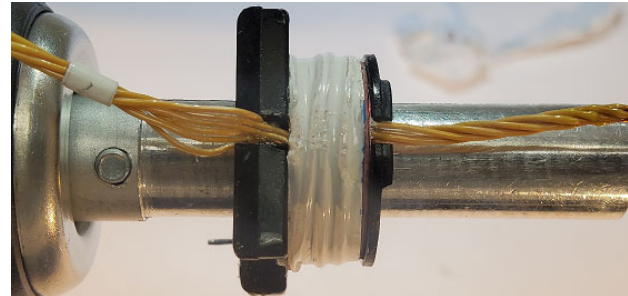

Secondary Wire

Fold the secondary fly lead wires (FL1) from left to right as shown in the figure.

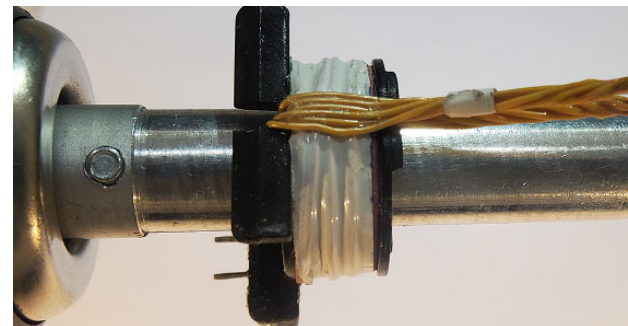

Apply 1 layer of polyester tape, Item [8] for insulation

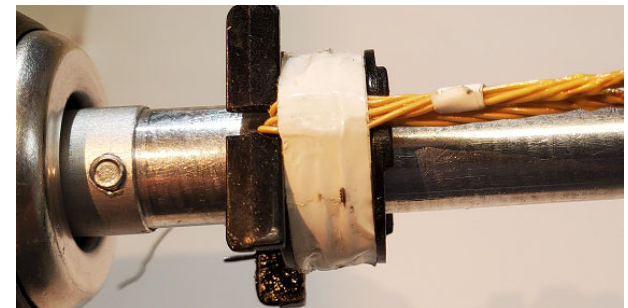

Core Fixing and Varnishing

Prepare a AWG # 26 TIN wire, Item 7. Terminate the wire on Pin 4 and lay it out on top of the core as shown in the figure.

Fix top and bottom core together with the TIN wire with tape, Item (9)

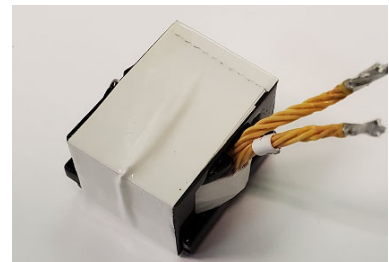
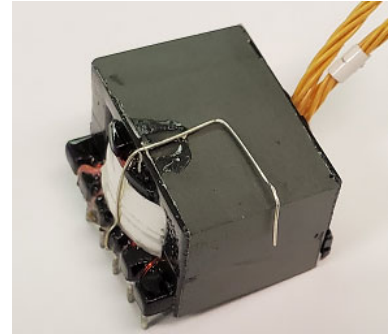
**Safety Insulation Tape**

Add double layer safety Insulation tapes as shown in the figures.



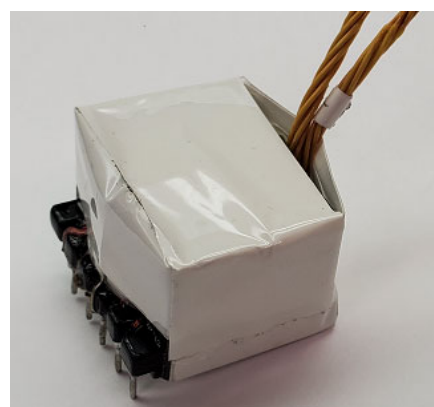
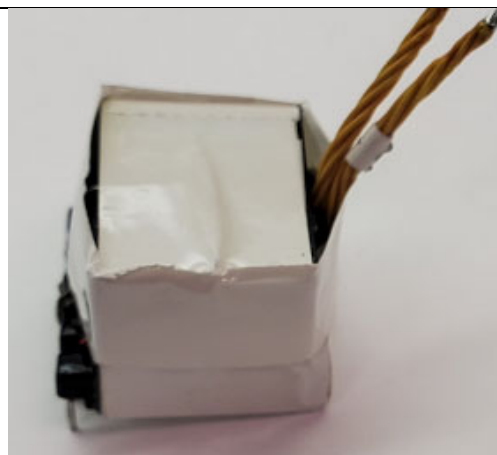

Fly Lead Wires Dimensions

Fly lead wire length is 22mm.

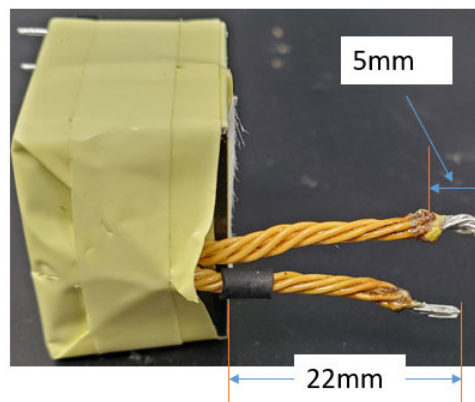

8 Transformer (T1) Spreadsheet

1	ACDC_InnoSwitch3-CP_Flyback_050420; Rev.1.5; Copyright Power Integrations 2020	INPUT	INFO	OUTPUT	UNITS	InnoSwitch3-CP Flyback Design Spreadsheet
2	APPLICATION VARIABLES					
3	VAC_MIN	100		100	V	Minimum AC line voltage
4	VAC_MAX	132		132	V	Maximum AC input voltage
5	VAC_RANGE			LOW LINE		AC line voltage range
6	FLINE			60	Hz	AC line voltage frequency
7	CAP_INPUT	81.0		81.0	uF	Input capacitance
9	SET-POINT 1					
10	VOUT1	20.00		20.00	V	Output voltage 1, should be the highest output voltage required
11	IOUT1	3.000		3.000	A	Output current 1
12	POUT1			60.00	W	Output power 1
13	EFFICIENCY1	0.94		0.94		Converter efficiency for output 1
14	Z_FACTOR1	0.50		0.50		Z-factor for output 1
16	SET-POINT 2					
17	VOUT2	15.00		15.00	V	Output voltage 2
18	IOUT2	3.000		3.000	A	Output current 2
19	POUT2			45.00	W	Output power 2
20	EFFICIENCY2	0.90		0.90		Converter efficiency for output 2
21	Z_FACTOR2	0.50		0.50		Z-factor for output 2
23	SET-POINT 3					
24	VOUT3	9.00		9.00	V	Output voltage 3
25	IOUT3	5.000		5.000	A	Output current 3
26	POUT3			45.00	W	Output power 3
27	EFFICIENCY3	0.90		0.90		Converter efficiency for output 3
28	Z_FACTOR3	0.50		0.50		Z-factor for output 3
30	SET-POINT 4					
31	VOUT4	5.00		5.00	V	Output voltage 4
32	IOUT4	6.500		6.500	A	Output current 4
33	POUT4			32.50	W	Output power 4
34	EFFICIENCY4	0.90		0.90		Converter efficiency for output 4
35	Z_FACTOR4	0.50		0.50		Z-factor for output 4
72	CDC	0		0	mV	Cable drop compensation desired at maximum output current
73	BASE_SETPOINT	4		4		Base SET-POINT voltage to determine the feedback network lower resistor value
77	PRIMARY CONTROLLER SELECTION					
78	ENCLOSURE	OPEN FRAME		OPEN FRAME		Power supply enclosure
79	ILIMIT_MODE	STANDARD		STANDARD		Device current limit mode
80	VDRAIN_BREAKDOWN	750		750	V	Device breakdown voltage
81	DEVICE_GENERIC	INN32X0		INN32X0		Device selection
82	DEVICE_CODE			INN3270C		Device code
83	PDEVICE_MAX			85	W	Device maximum power capability
84	RDSON_25DEG			0.39	Ω	Primary switch on-time resistance at 25°C
85	RDSON_100DEG			0.54	Ω	Primary switch on-time resistance at 100°C
86	ILIMIT_MIN			2.139	A	Primary switch minimum current limit
87	ILIMIT_TYP			2.300	A	Primary switch typical current limit
88	ILIMIT_MAX			2.461	A	Primary switch maximum current limit



89	VDRAIN_ON_PRSW			0.33	V	Primary switch on-time voltage drop
90	VDRAIN_OFF_PRSW			395.248	V	Peak drain voltage on the primary switch during turn-off
94	WORST CASE ELECTRICAL PARAMETERS					
95	FSWITCHING_MAX	76000		76000	Hz	Maximum switching frequency at full load and the valley of the minimum input AC voltage
96	VOR	140.0		140.0	V	Voltage reflected to the primary winding (corresponding to set-point 1) when the primary switch turns off
97	VMIN			101.06	V	Valley of the rectified minimum input AC voltage at full load
98	KP			0.695		Measure of continuous/discontinuous mode of operation
99	MODE_OPERATION			CCM		Mode of operation
100	DUTYCYCLE			0.582		Primary switch duty cycle
101	TIME_ON			9.48	us	Primary switch on-time
102	TIME_OFF			5.51	us	Primary switch off-time
103	LPRIMARY_MIN			378.5	uH	Minimum primary magnetizing inductance
104	LPRIMARY_TYP			398.4	uH	Typical primary magnetizing inductance
105	LPRIMARY_TOL			5.0	%	Primary magnetizing inductance tolerance
106	LPRIMARY_MAX			418.4	uH	Maximum primary magnetizing inductance
108	PRIMARY CURRENT					
109	Iavg_PRIMARY			0.615	A	Primary switch average current
110	IPEAK_PRIMARY			2.312	A	Primary switch peak current
111	IPEDESTAL_PRIMARY			0.587	A	Primary switch current pedestal
112	IRIPPLE_PRIMARY			2.312	A	Primary switch ripple current
113	IRMS_PRIMARY			0.973	A	Primary switch RMS current
115	SECONDARY CURRENT					
116	IPEAK_SECONDARY			16.187	A	Secondary winding peak current
117	IPEDESTAL_SECONDARY			4.109	A	Secondary winding pedestal current
118	IRMS_SECONDARY			8.306	A	Secondary winding RMS current
119	IRIPPLE_CAP_OUT			5.461	A	Output capacitor ripple current
123	TRANSFORMER CONSTRUCTION PARAMETERS					
124	CORE SELECTION					
125	CORE	EQ25	Info	EQ25		The transformer windings may not fit: pick a bigger core or bobbin and refer to the Transformer Parameters tab for fit calculations
126	CORE NAME			EQ25-3C95		Core code
127	AE			100.0	mm ²	Core cross sectional area
128	LE			41.4	mm	Core magnetic path length
129	AL			5710	nH	Ungapped core effective inductance per turns squared
130	VE			4145	mm ³	Core volume
131	BOBBIN NAME			TBI-235-01091.1206		Bobbin name



132	AW			34.8	mm ²	Bobbin window area
133	BW			8.10	mm	Bobbin width
134	MARGIN			0.0	mm	Bobbin safety margin
136	PRIMARY WINDING					
137	NPRIMARY			28		Primary winding number of turns
138	BPEAK			3764	Gauss	Peak flux density
139	BMAX			3411	Gauss	Maximum flux density
140	BAC			1705	Gauss	AC flux density (0.5 x Peak to Peak)
141	ALG			508	nH	Typical gapped core effective inductance per turns squared
142	LG			0.225	mm	Core gap length
143	LAYERS_PRIMARY			2		Primary winding number of layers
144	AWG_PRIMARY			24		Primary wire gauge
145	OD_PRIMARY_INSULATED			0.577	mm	Primary wire insulated outer diameter
146	OD_PRIMARY_BARE			0.511	mm	Primary wire bare outer diameter
147	CMA_PRIMARY			415.1	Cmils/A	Primary winding wire CMA
149	SECONDARY WINDING					
150	NSECONDARY			4		Secondary winding number of turns
151	AWG_SECONDARY			17		Secondary wire gauge
152	OD_SECONDARY_INSULATED			1.454	mm	Secondary wire insulated outer diameter
153	OD_SECONDARY_BARE			1.150	mm	Secondary wire bare outer diameter
154	CMA_SECONDARY			246.6	Cmils/A	Secondary winding wire CMA
156	BIAS WINDING					
157	NBIAS			7		Bias winding number of turns
161	PRIMARY COMPONENTS SELECTION					
162	LINE UNDERVOLTAGE					
163	BROWN-IN REQUIRED	45.00		45.00	V	Required line brown-in threshold
164	RLS			2.26	MΩ	Connect two 1.13 MΩ resistors to the V-pin for the required UV/OV threshold
165	BROWN-IN ACTUAL			45.49	V	Actual brown-in threshold using standard resistors
166	BROWN-OUT ACTUAL			41.16	V	Actual brown-out threshold using standard resistors
168	LINE OVERVOLTAGE					
169	OVERVOLTAGE_LINE			189.03	V	Actual AC RMS line over-voltage threshold
171	BIAS WINDING					
172	VBIAS	8.00	Info	8.00	V	The rectified bias voltage maybe too low to supply the BP pin: Increase the rectified bias voltage to a value higher than 9V
173	VF_BIAS			0.70	V	Bias winding diode forward drop
174	VREVERSE_BIASDIODE			54.31	V	Bias diode reverse voltage (not accounting parasitic voltage ring)
175	CBIAS			22	uF	Bias winding rectification capacitor
176	CBPP			0.47	uF	BPP pin capacitor
180	SECONDARY COMPONENTS SELECTION					
181	RECTIFIER					



182	VDRAIN_OFF_SR FET			46.46	V	Secondary rectifier reverse voltage (not accounting parasitic voltage ring)
183	SR FET	SiR826ADP		SiR826ADP		Secondary rectifier (Logic MOSFET)
184	VBREAKDOWN_SR FET			80	V	Secondary rectifier breakdown voltage
185	RDSON_SR FET			8.7	mΩ	SR FET on time drain resistance at 25degC for VGS=4.4V
187	FEEDBACK COMPONENTS					
188	RFB_UPPER			100.00	kΩ	Upper feedback resistor (connected to the output terminal)
189	RFB_LOWER			34.00	kΩ	Lower feedback resistor required to obtain the output for cable drop compensation
190	CFB_LOWER			330	pF	Lower feedback resistor decoupling capacitor

9 Performance Data

All measurements were performed at room ambient temperature otherwise specified. Please refer to below output voltage selector guide when changing output voltage.

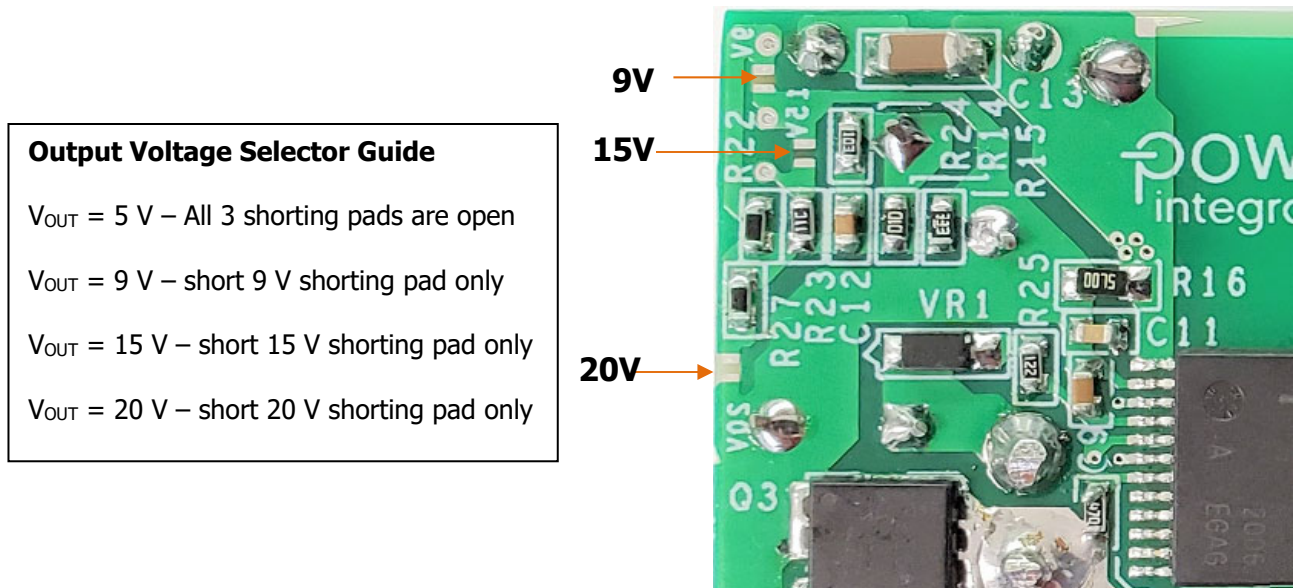

Figure 9 – Output Voltage Selector Guide.

9.1 System Full Load Efficiency

Output voltage was measured at PCB output terminal Pin

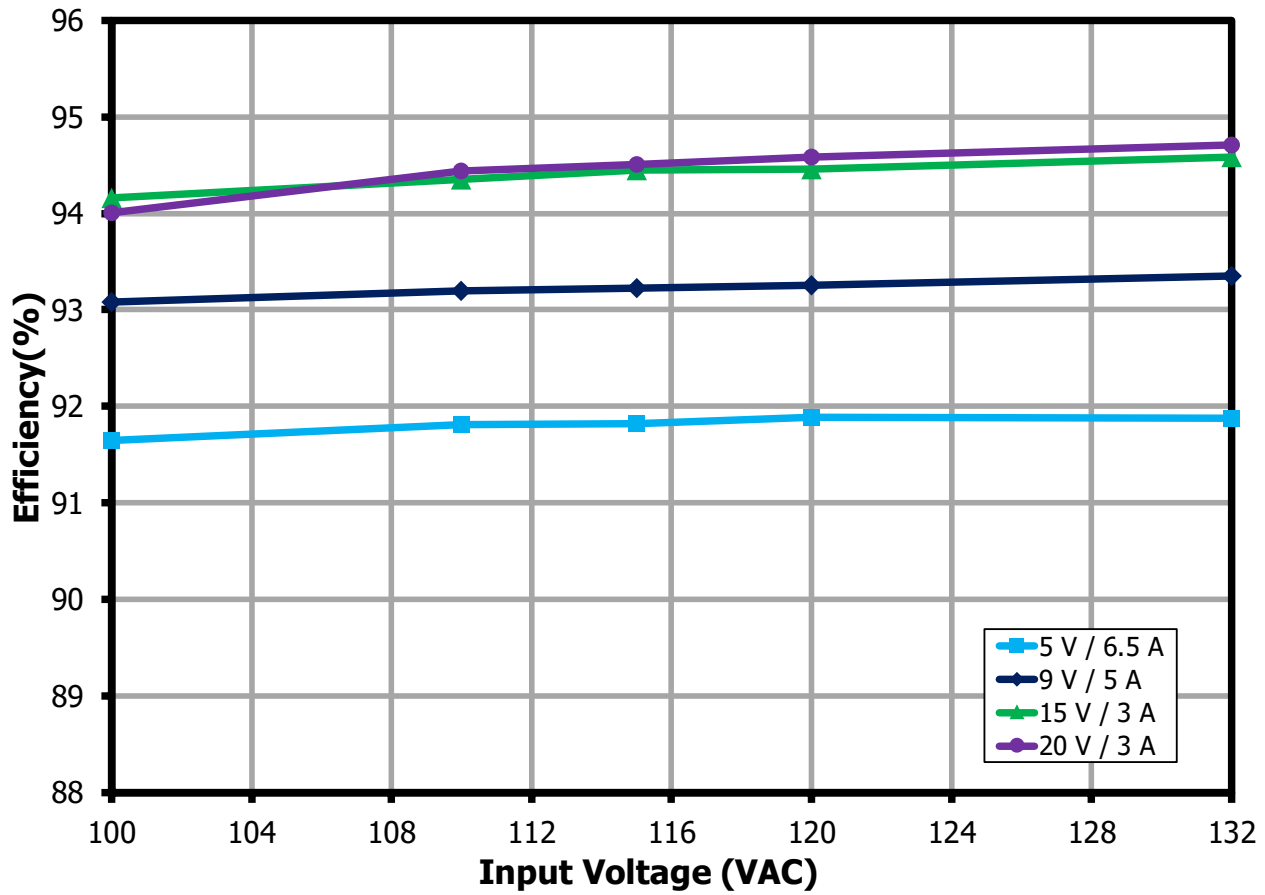

Figure 10 – System Full Load Efficiency vs. Line at 20 VDC.

9.2 Energy Efficiency

9.2.1 System Average Efficiency

Note: Unit tested with with 5 mins soak time and 1 min soak time per load step.

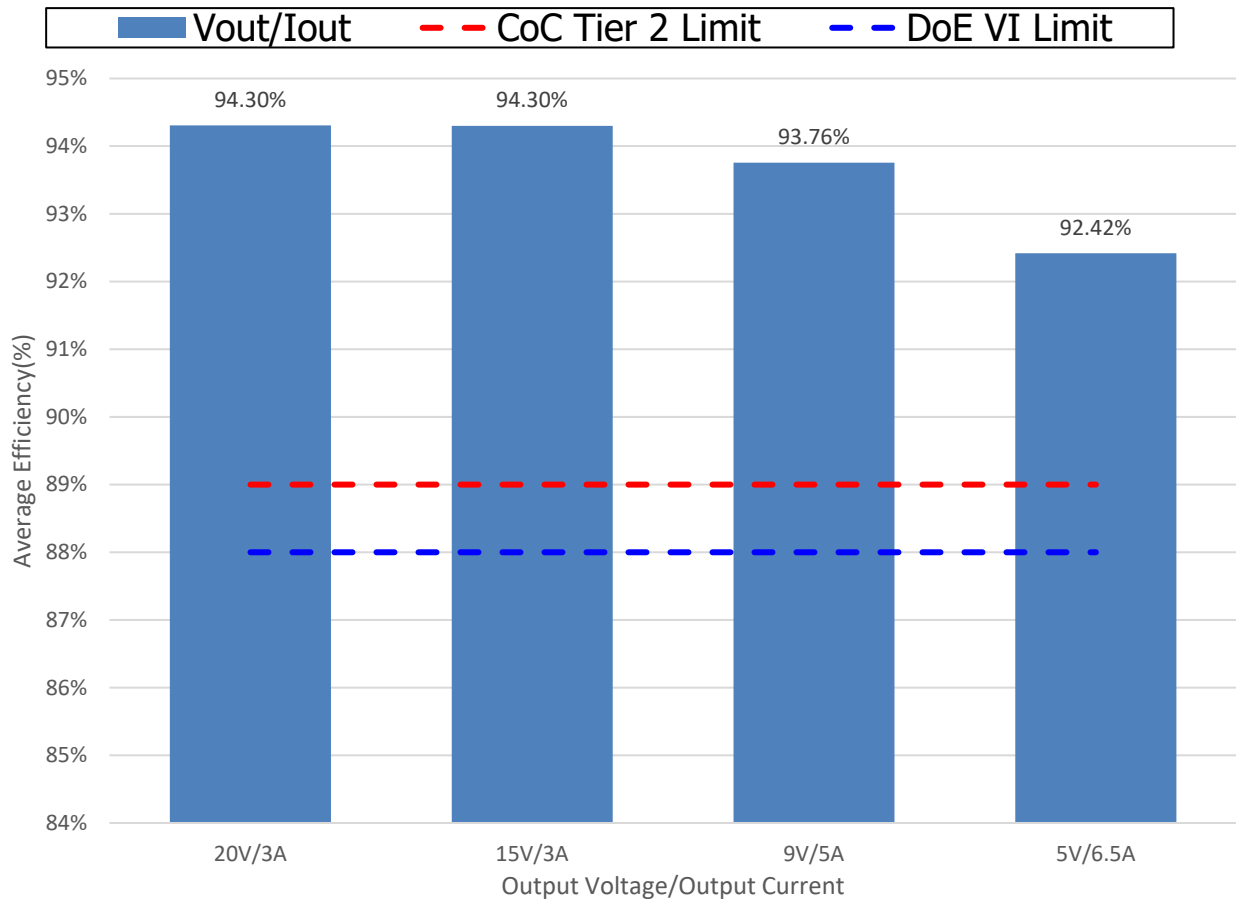

Figure 11 – Average Efficiency at 115 V 60 Hz.

9.2.2 Efficiency at 10% Load

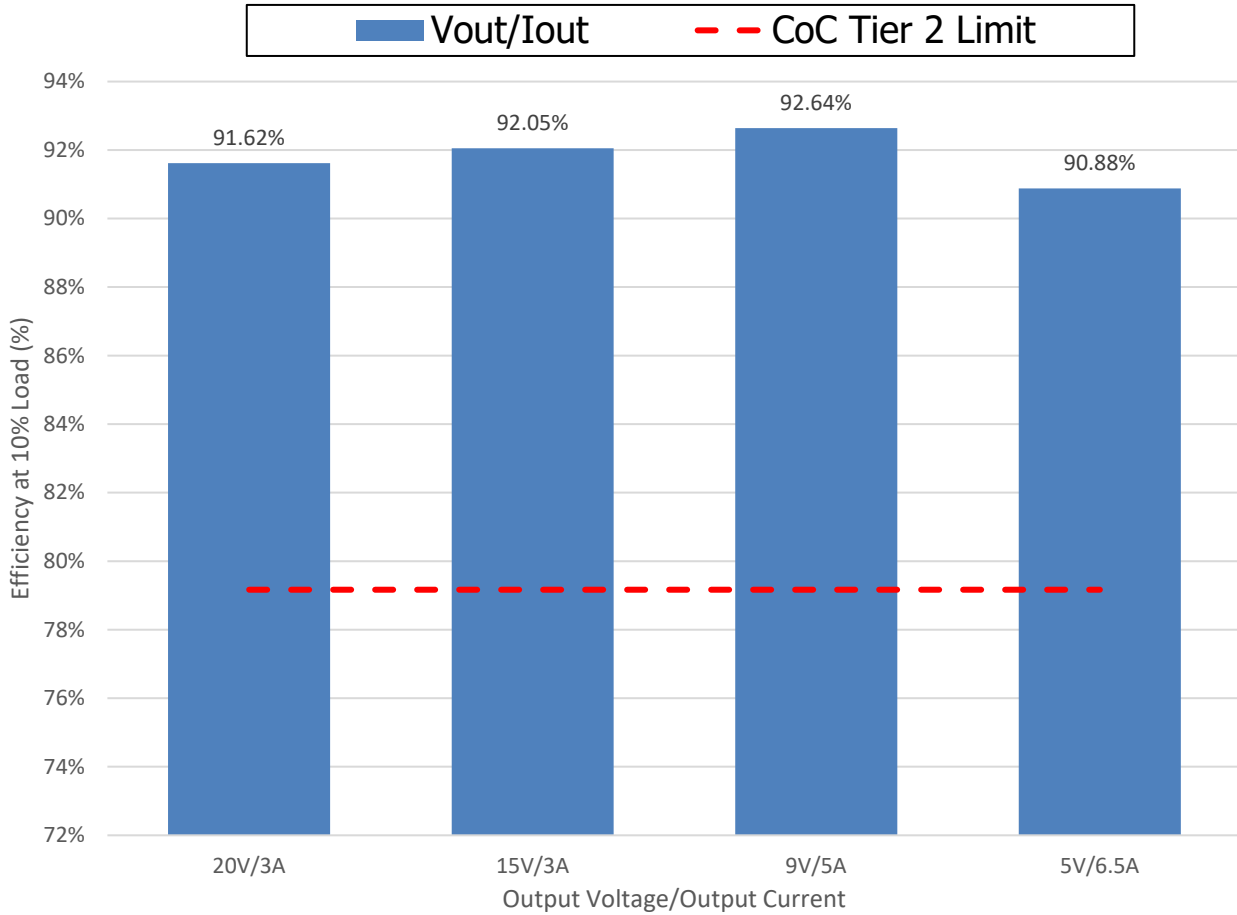

Figure 12 – Efficiency at 10 % Load , 115 VAC 60 Hz.

9.3 **Efficiency vs. Load**

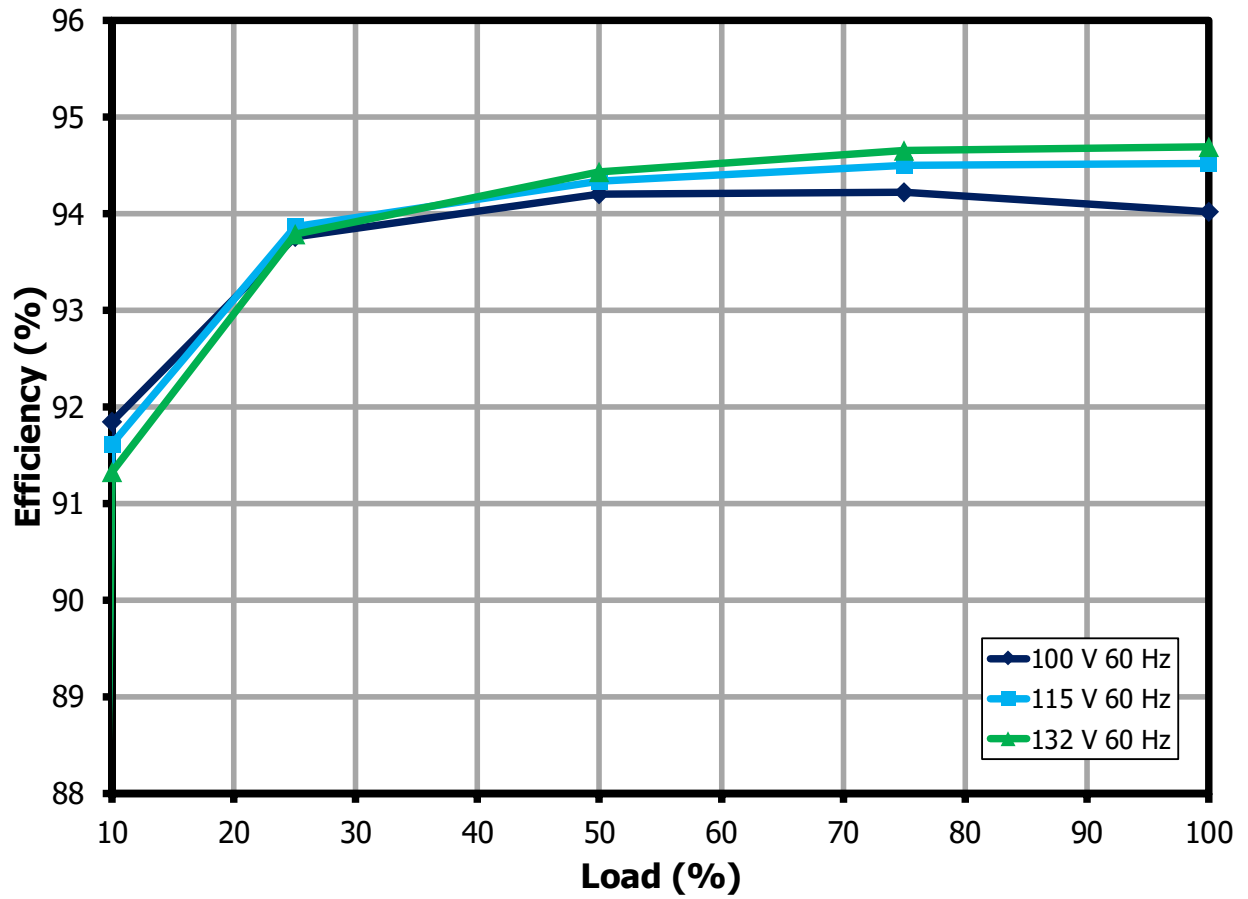

Figure 13 – System Efficiency vs. Load at $V_{OUT} = 20$ VDC.

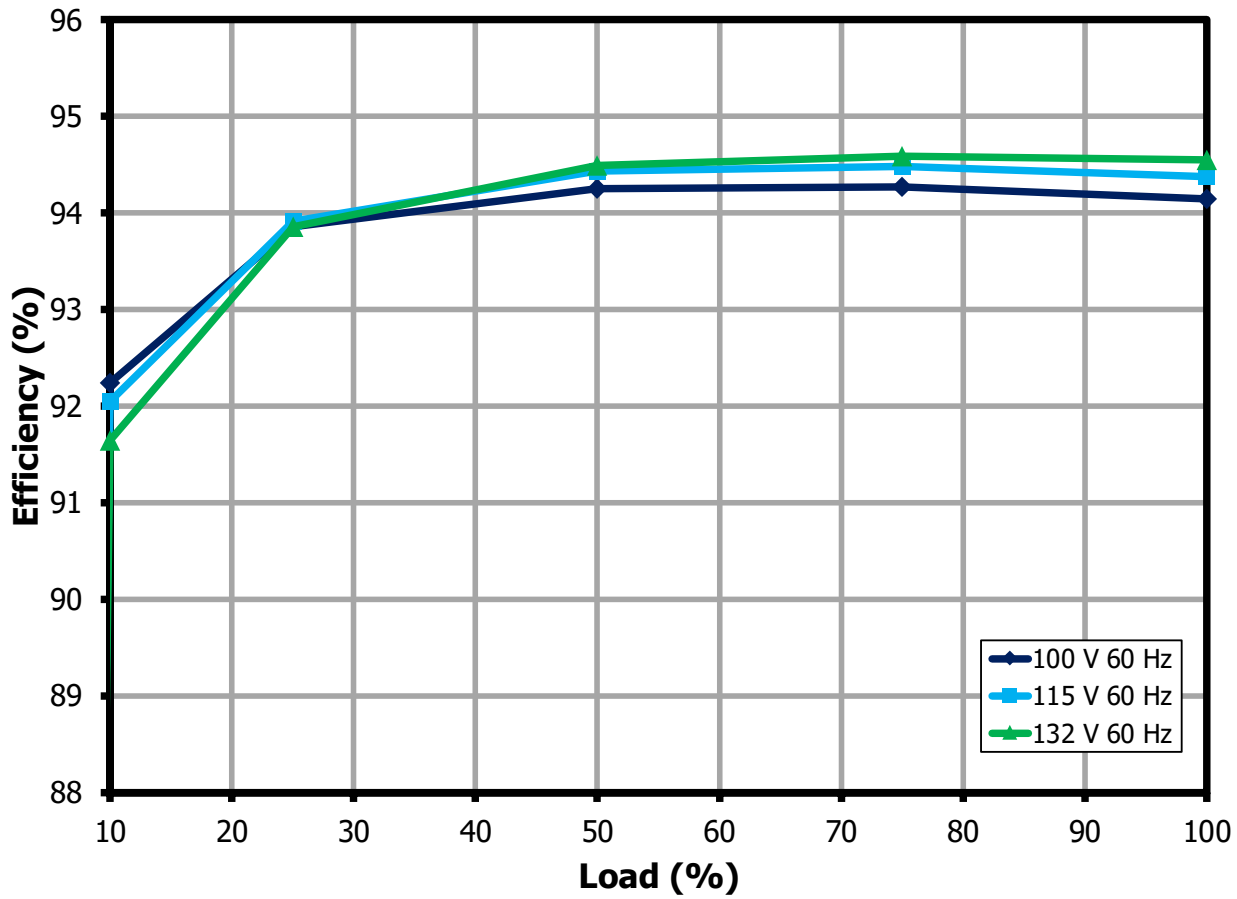

Figure 14 – System Efficiency vs. Load at $V_{OUT} = 15$ VDC.

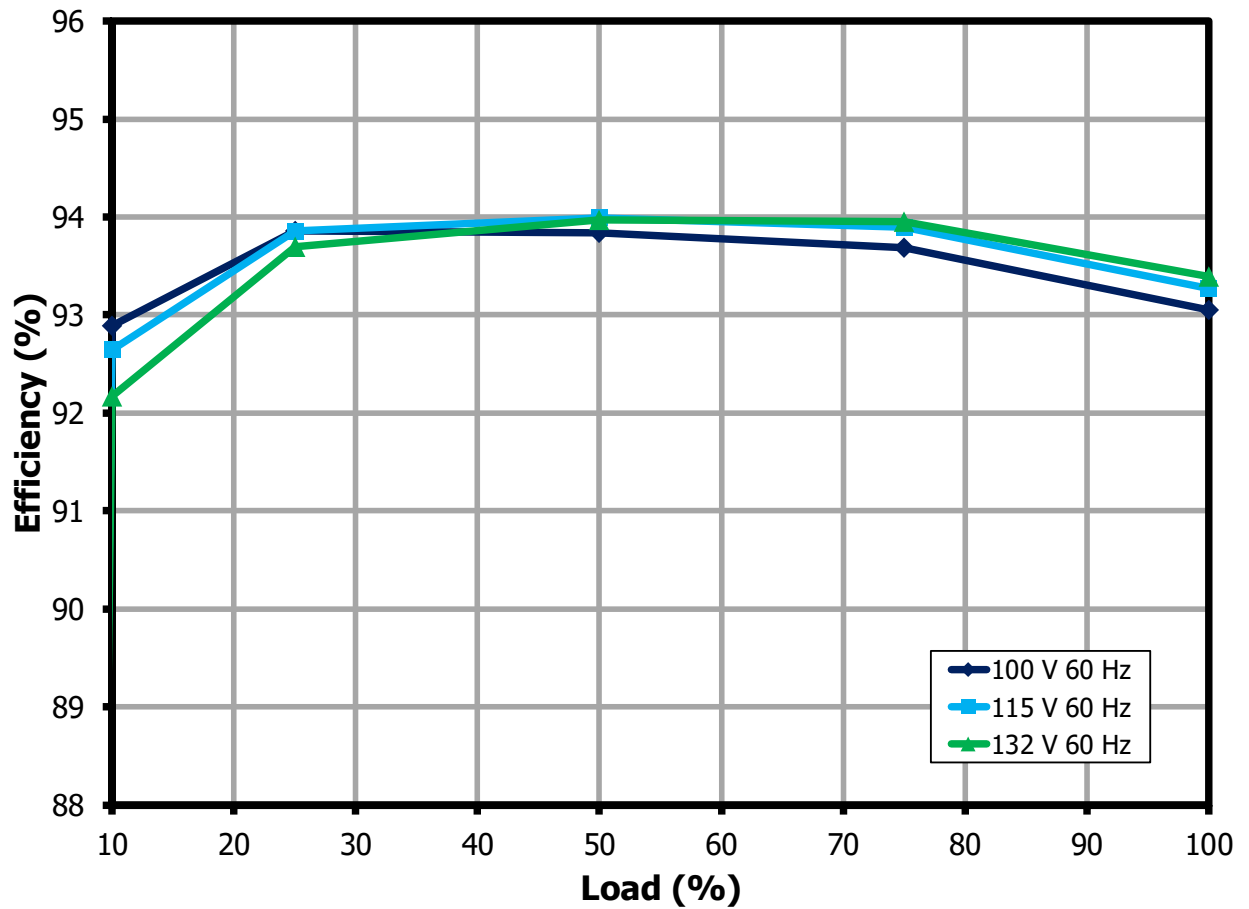

Figure 15 – System Efficiency vs. Load at $V_{OUT} = 9$ VDC.

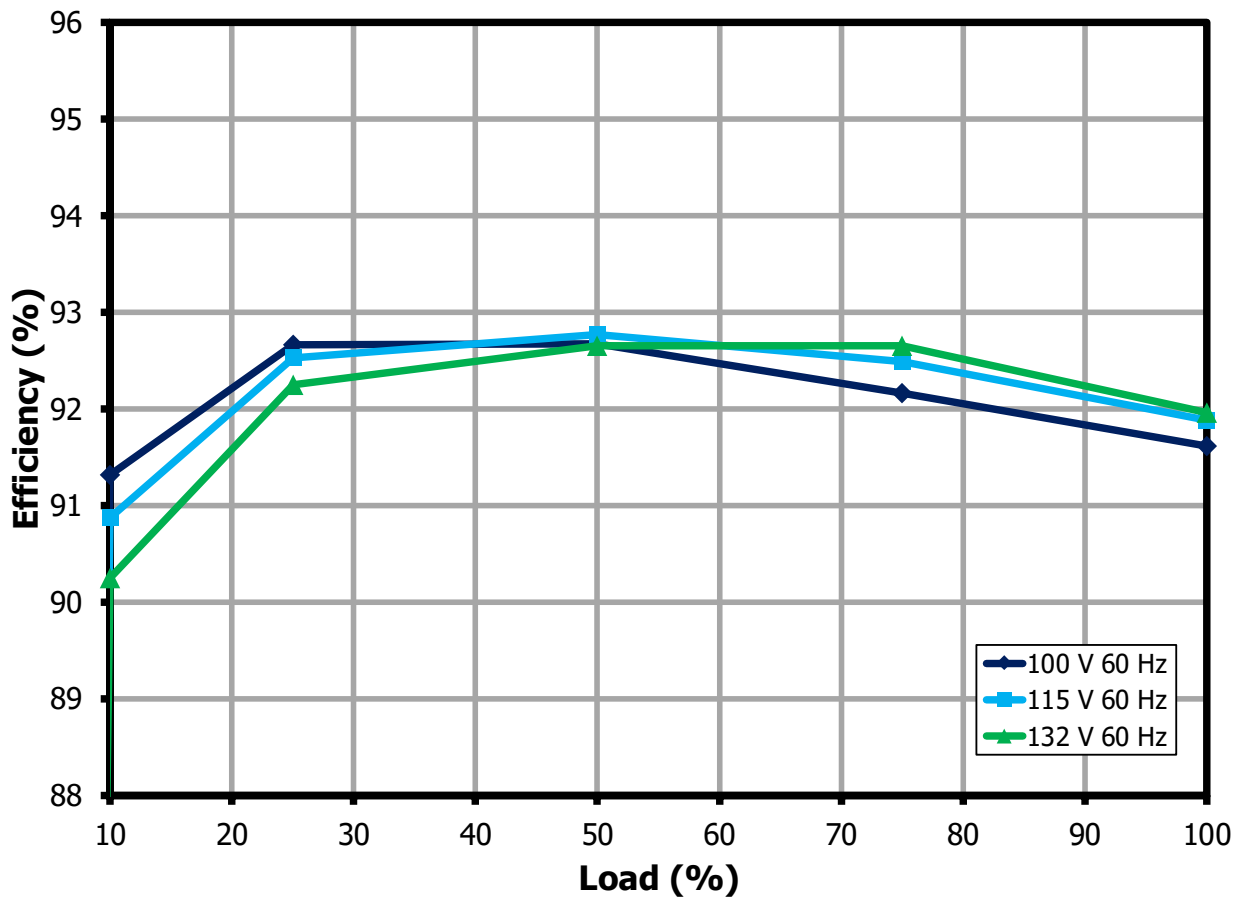

Figure 16 – System Efficiency vs. Load at $V_{OUT} = 5$ VDC.

9.4 **No-Load Input Power**

Note: Tested at $V_{OUT} = 5\text{ V}$, with 30 seconds soak time every input line.

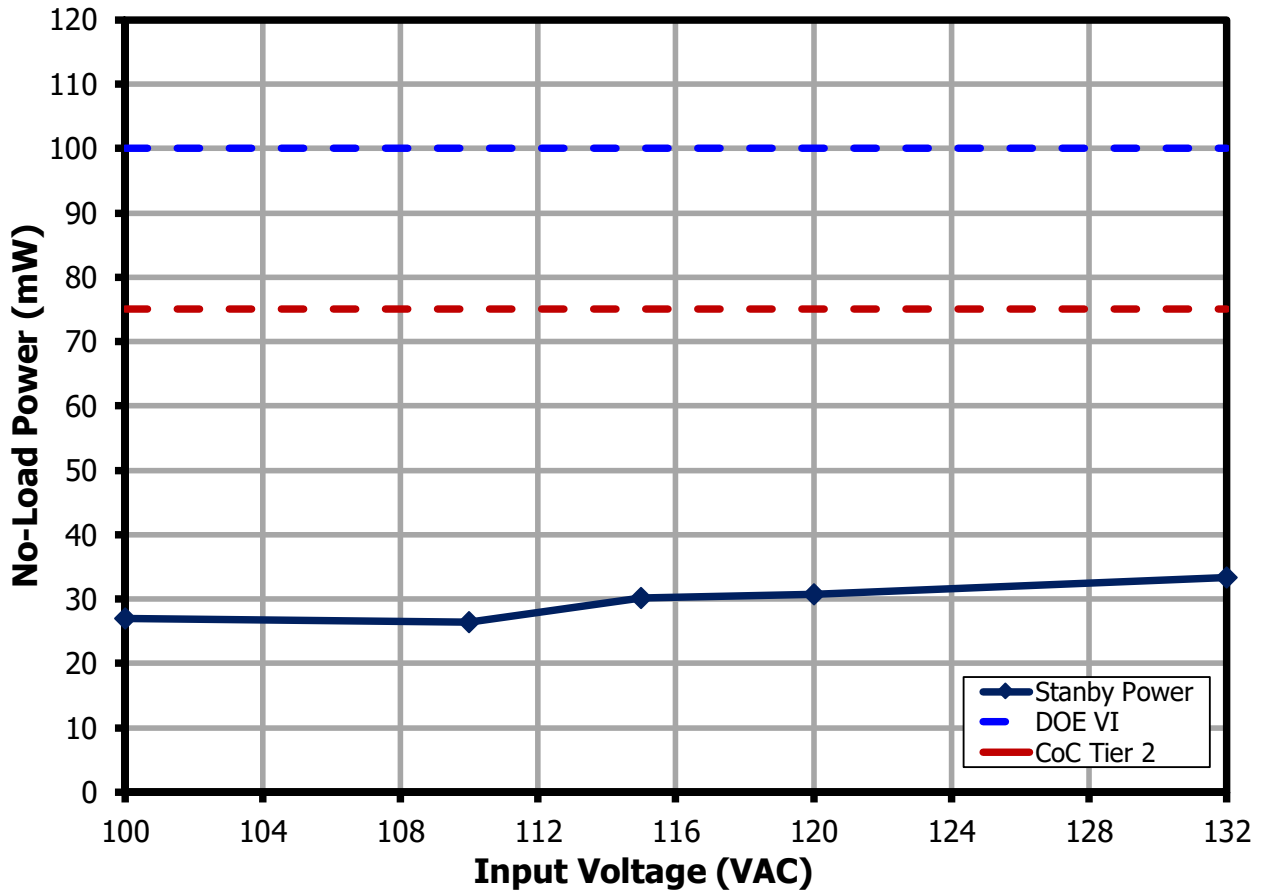

Figure 17 – No-Load Input Power vs. Line at $V_{OUT} = 5\text{ V}$.

9.5 Output Voltage Load Regulation

E-load is set at CC Mode Load

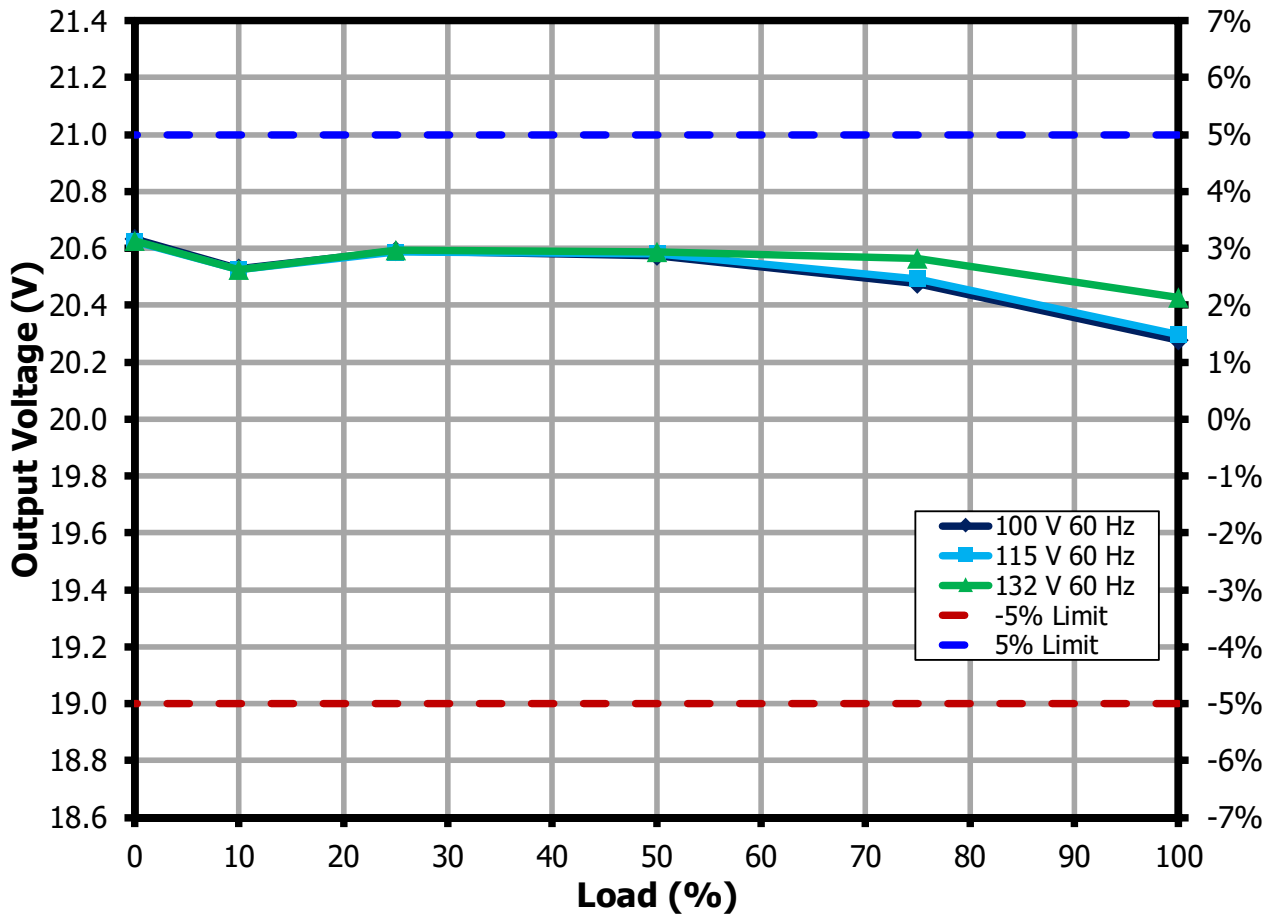

Figure 18 – Voltage Regulation vs. Load at $V_{OUT} = 20 \text{ VDC} / 3 \text{ A}$.

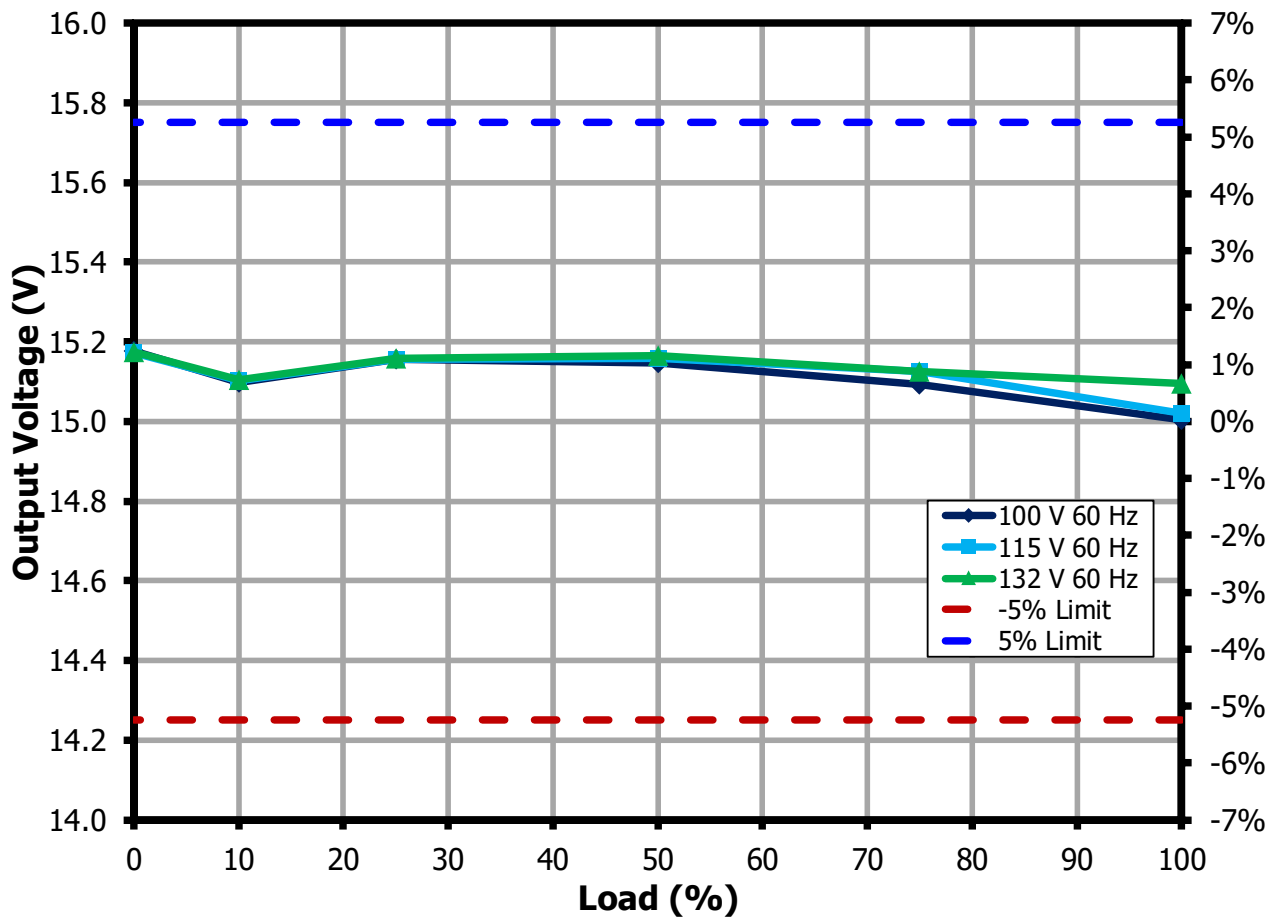

Figure 19 – Voltage Regulation vs. Load at $V_{OUT} = 15\text{ VDC} / 3\text{ A}$.

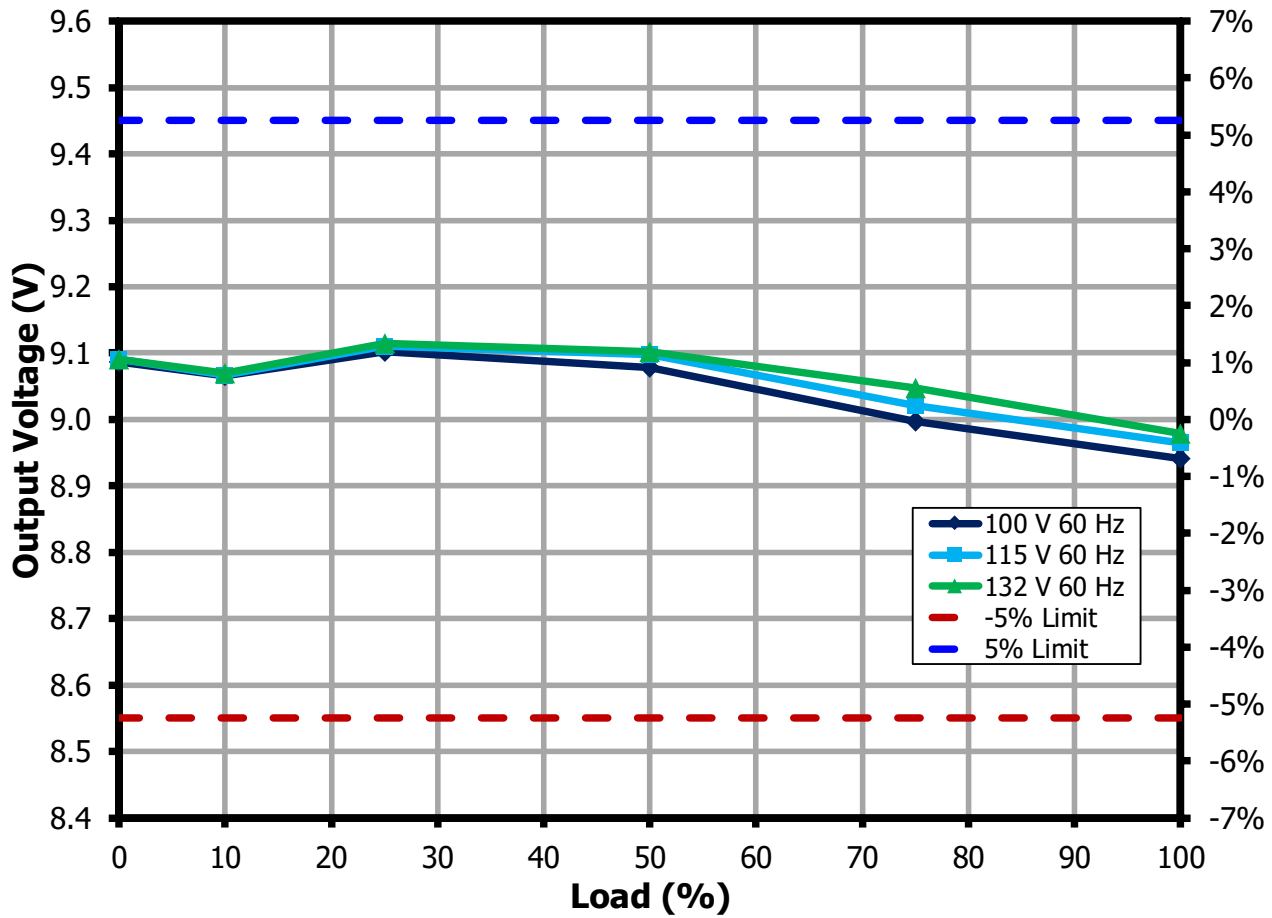

Figure 20 – Voltage Regulation vs. Load at $V_{OUT} = 9\text{ VDC} / 5\text{ A}$.

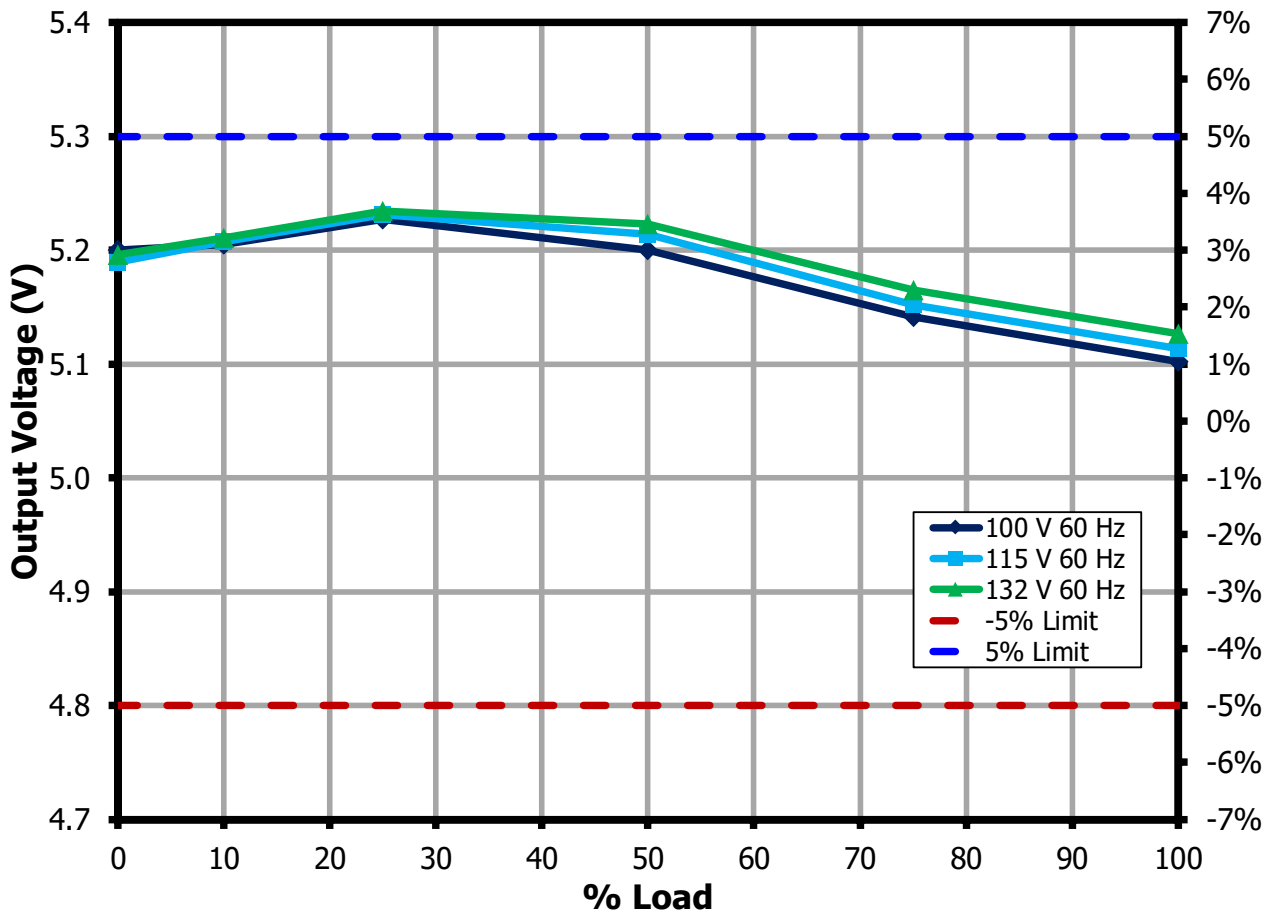

Figure 21 – Voltage Regulation vs. Load at $V_{OUT} = 5 \text{ VDC} / 6.5 \text{ A}$.

9.6 **VI Characteristic Curve**

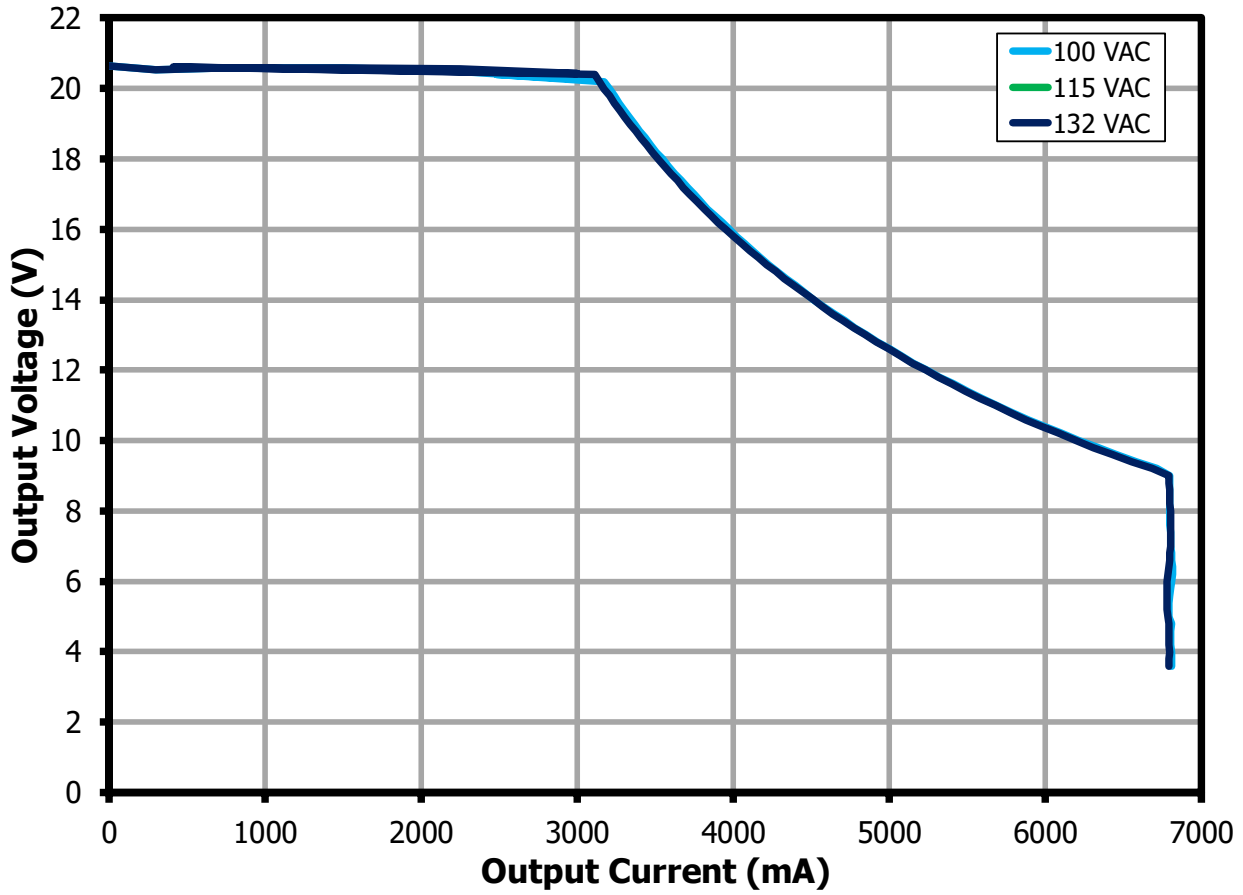

Figure 22 – VI Curve at $V_{OUT} = 20\text{ V}$.

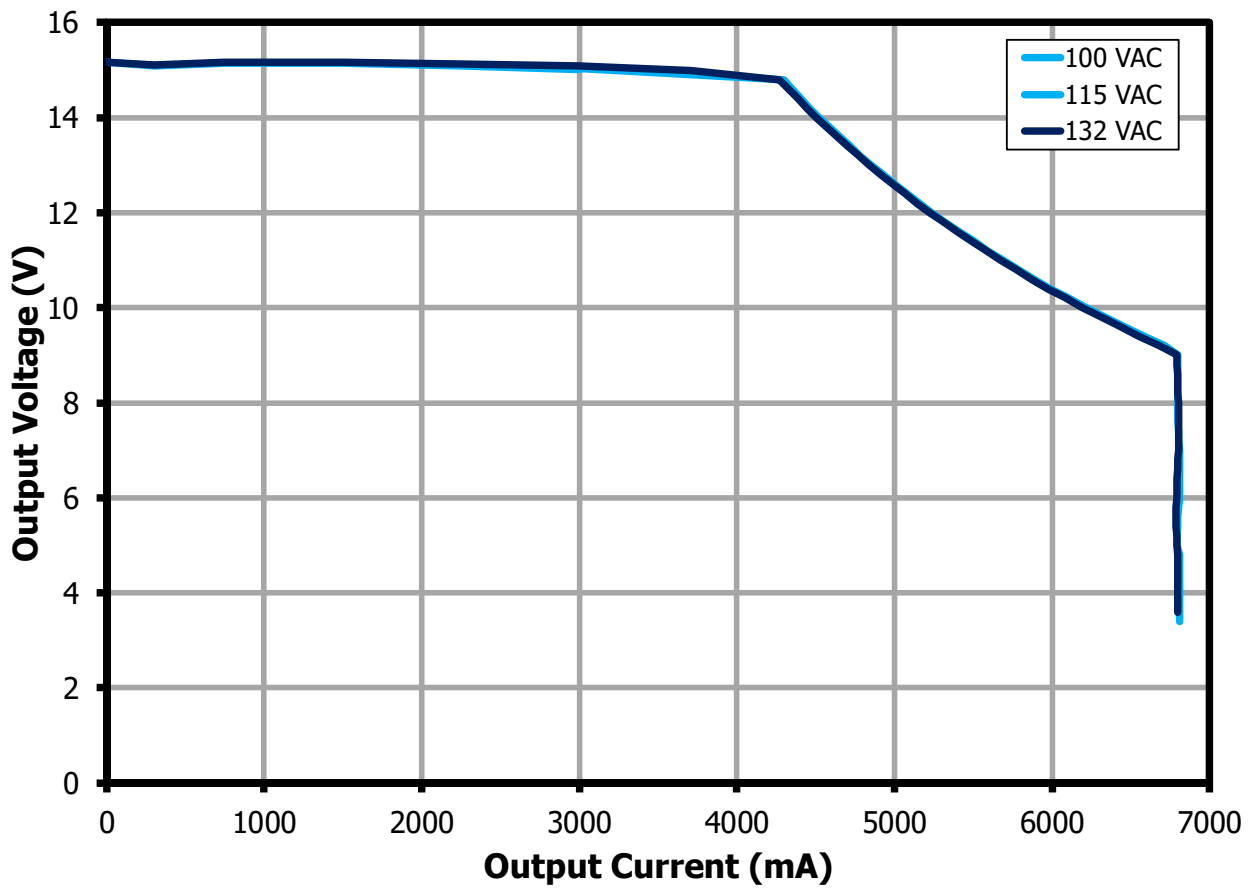

Figure 23 – VI Curve at $V_{OUT} = 15\text{ V}$.

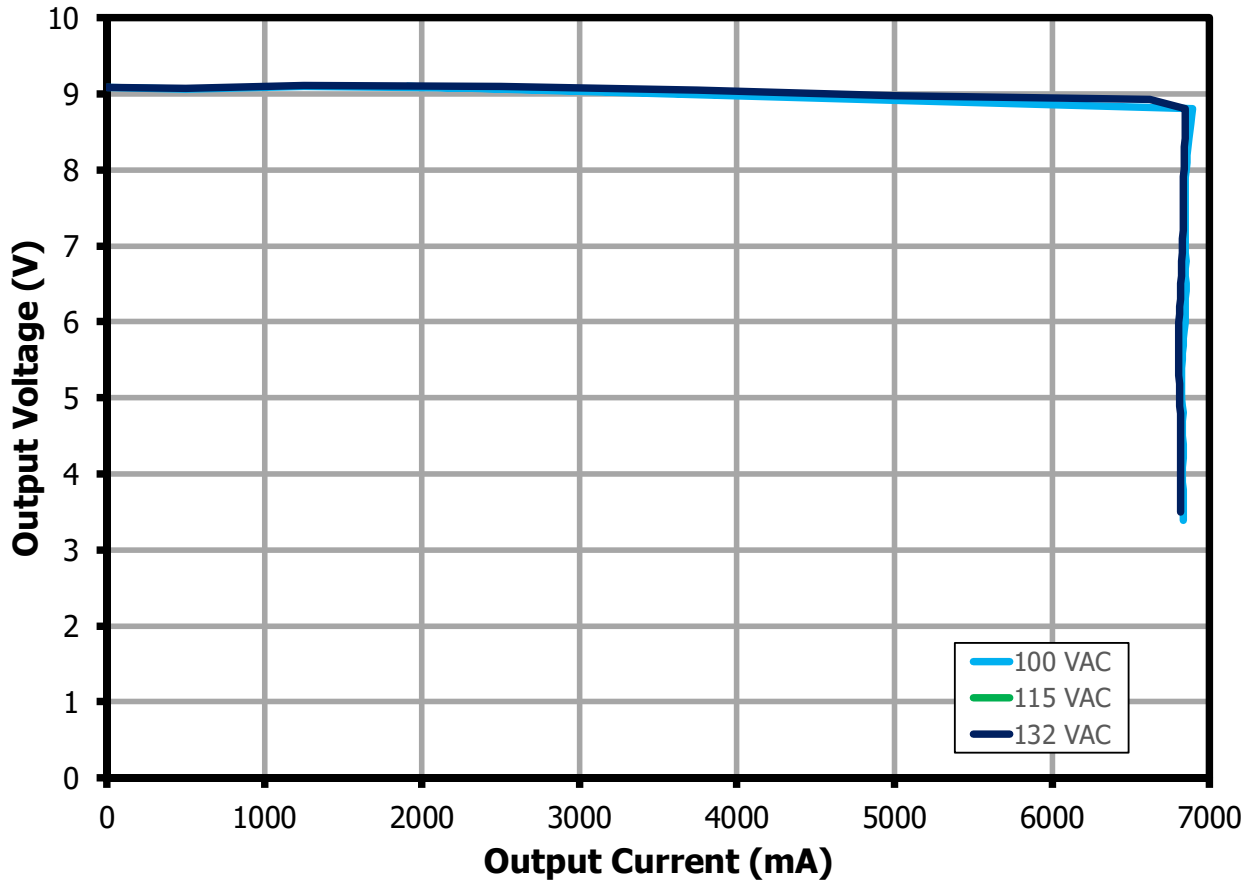

Figure 24 – VI Curve at $V_{OUT} = 9\text{ V}$.

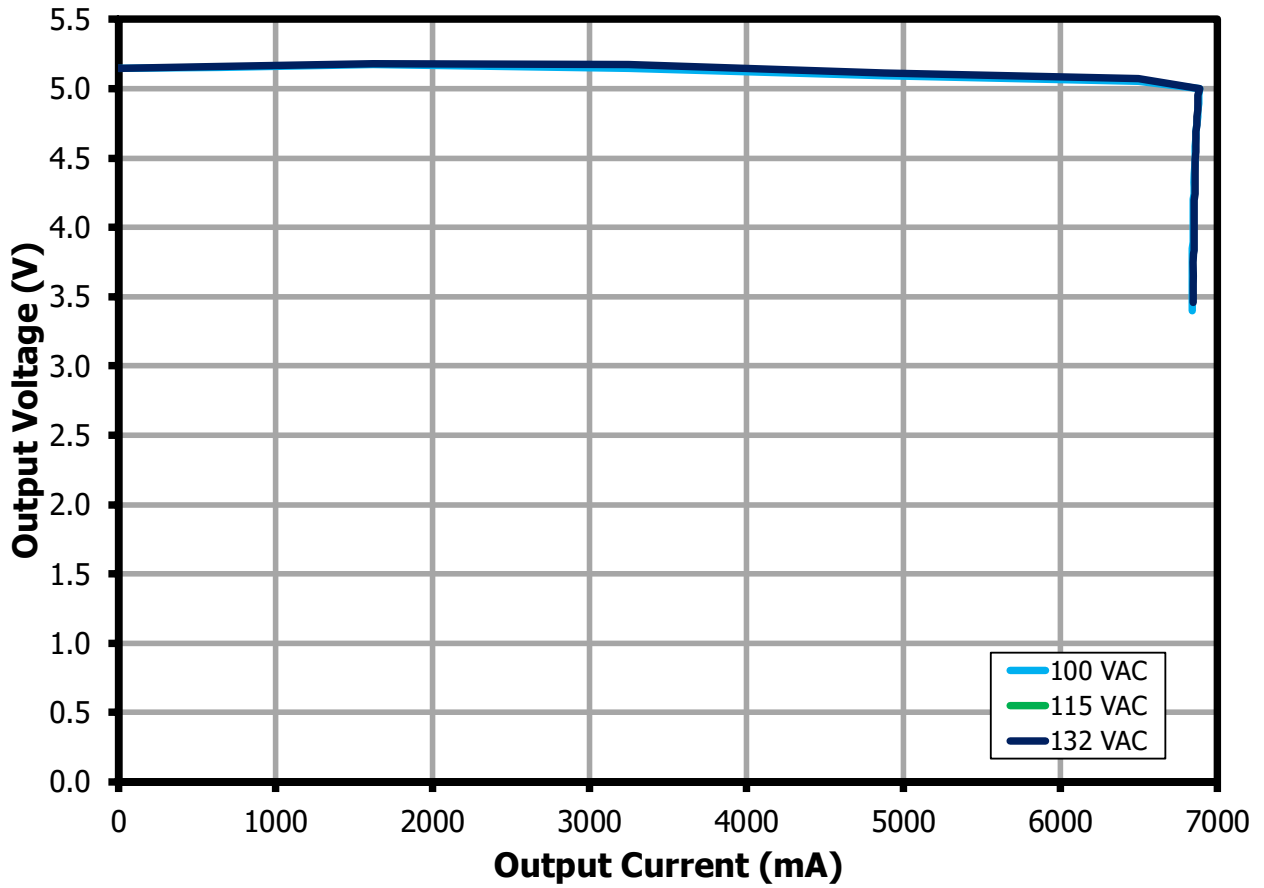

Figure 25 – VI Curve at $V_{OUT} = 5\text{ V}$.

9.7 **Test Data**

9.7.1 Electrical Test Data at Full Load

	Load Setting		Input Measurement			Load Measurement			Efficiency (%)
	% Load	Load (A)	V _{IN} (V _{RMS})	I _{IN} (A _{RMS})	P _{IN} (W)	V _{OUT} (V _{DC})	I _{OUT} (mA _{DC})	P _{OUT} (W)	
20 V / 3 A	100	60	99.94	1177.60	64.68	20.28	2998.65	60.80	94.00
	110	60	109.90	1107.40	64.53	20.32	2999.03	60.94	94.44
	115	60	114.96	1075.70	64.44	20.31	2998.65	60.90	94.51
	120	60	119.94	1048.30	64.43	20.32	2998.65	60.94	94.58
	132	60	131.94	996.80	64.74	20.45	2998.65	61.31	94.71
	15 V / 3 A	100	60	99.96	913.70	47.78	15.00	2998.65	44.99
110		60	109.91	863.80	47.73	15.02	2998.65	45.03	94.35
115		60	114.97	842.10	47.71	15.02	2999.03	45.06	94.45
120		60	119.95	823.40	47.76	15.04	2999.03	45.11	94.46
132		60	131.95	784.90	47.87	15.10	2999.03	45.27	94.58
9 V / 5 A		100	60	99.96	919.60	48.02	8.94	4999.12	44.70
	110	60	109.91	870.10	48.04	8.96	4998.75	44.77	93.20
	115	60	114.97	849.00	48.06	8.96	4999.12	44.80	93.23
	120	60	119.95	830.00	48.08	8.97	4999.12	44.84	93.25
	132	60	131.95	789.80	48.09	8.98	4998.75	44.89	93.35
	5 V / 6.5 A	100	60	99.97	726.80	35.82	5.05	6499.20	32.83
110		60	109.92	690.50	35.83	5.06	6499.20	32.90	91.81
115		60	114.98	674.70	35.84	5.06	6498.82	32.91	91.82
120		60	119.96	660.60	35.86	5.07	6498.82	32.95	91.89
132		60	131.96	630.50	35.92	5.08	6499.20	33.00	91.87

9.7.2 Energy Efficiency Test Data

	Load Setting		Input Measurement			Load Measurement			Efficiency (%)
	% Load	Load (A)	V _{IN} (V _{RMS})	I _{IN} (A _{RMS})	P _{IN} (W)	V _{OUT} (V _{DC})	I _{OUT} (mA _{DC})	P _{OUT} (W)	
20 V / 3 A	100	3000	114.96	1072.70	64.40	20.30	2999.03	60.87	94.52
	75	2250	114.97	859.70	48.78	20.49	2249.55	46.10	94.50
	50	1500	114.98	631.50	32.70	20.58	1498.95	30.85	94.34
	25	750	115.00	371.70	16.43	20.59	749.10	15.42	93.87
	10	300	115.00	187.29	6.70	20.53	299.19	6.14	91.62
	Average Efficiency at 20V								
15 V / 3 A	100	3000	114.97	841.30	47.72	15.02	2998.28	45.04	94.38
	75	2250	114.98	676.50	36.01	15.13	2249.18	34.02	94.48
	50	1500	114.99	496.50	24.06	15.16	1498.95	22.72	94.43
	25	750	115.00	295.80	12.09	15.16	749.10	11.35	93.91
	10	300	115.01	141.45	4.91	15.10	299.19	4.52	92.05
	Average Efficiency at 20V								
9 V / 5 A	100	5000	114.98	848.30	48.05	8.96	4999.50	44.82	93.27
	75	3750	114.99	678.60	36.02	9.02	3749.25	33.82	93.90
	50	2500	114.99	500.10	24.19	9.10	2499.00	22.74	93.99
	25	1250	115.00	297.60	12.12	9.11	1248.75	11.38	93.86
	10	500	115.01	141.38	4.89	9.07	500.02	4.53	92.64
	Average Efficiency at 20V								
5 V / 6.5 A	100	6500	114.98	674.10	35.82	5.06	6499.20	32.91	91.88
	75	4875	114.99	541.60	26.89	5.10	4874.59	24.87	92.49
	50	3250	114.99	398.00	18.09	5.16	3249.60	16.78	92.77
	25	1625	115.00	239.36	9.10	5.18	1624.24	8.42	92.53
	10	650	115.01	109.25	3.69	5.16	649.62	3.35	90.88
	Average Efficiency at 20V								

9.7.3 Electrical Test Data at 20 V / 3 A

	Load Setting		Input Measurement			Load Measurement			Efficiency (%)
	% Load	Load (A)	V _{IN} (V _{RMS})	I _{IN} (A _{RMS})	P _{IN} (W)	V _{OUT} (V _{DC})	I _{OUT} (mA _{DC})	P _{OUT} (W)	
100 V 60 Hz	100	3000	99.94	1177.30	64.67	20.28	2998.65	60.80	94.02
	75	2250	99.96	935.90	48.88	20.48	2249.18	46.06	94.23
	50	1500	99.97	681.60	32.75	20.58	1499.33	30.85	94.20
	25	750	99.99	400.10	16.45	20.59	749.10	15.42	93.76
	10	300	100.00	203.84	6.70	20.53	299.57	6.15	91.85
	0	0	100.00	14.73	0.07	20.63	0	0	0.00
	115 V 60 Hz	100	3000	114.96	1072.70	64.40	20.30	2999.03	60.87
75		2250	114.97	859.70	48.78	20.49	2249.55	46.10	94.50
50		1500	114.98	631.50	32.70	20.58	1498.95	30.85	94.34
25		750	115.00	371.70	16.43	20.59	749.10	15.42	93.87
10		300	115.00	187.29	6.70	20.53	299.19	6.14	91.62
0		0	115.01	14.59	0.07	20.63	0	0	0.00
132 V 60 Hz		100	3000	131.94	992.70	64.70	20.43	2999.03	61.27
	75	2250	131.95	799.20	48.87	20.56	2249.55	46.26	94.66
	50	1500	131.96	587.20	32.67	20.59	1498.58	30.85	94.44
	25	750	131.97	350.80	16.45	20.60	749.10	15.43	93.79
	10	300	131.98	169.20	6.72	20.52	299.19	6.14	91.33
	0	0	131.98	14.54	0.07	20.63	0	0	0.00

9.7.4 Electrical Test Data at 15 V / 3 A

	Load Setting		Input Measurement			Load Measurement			Efficiency (%)
	% Load	Load (A)	V _{IN} (V _{RMS})	I _{IN} (A _{RMS})	P _{IN} (W)	V _{OUT} (V _{DC})	I _{OUT} (mA _{DC})	P _{OUT} (W)	
100 V 60 Hz	100	3000	99.96	914.50	47.79	15.00	2998.65	44.99	94.15
	75	2250	99.97	730.10	36.01	15.09	2249.18	33.95	94.27
	50	1500	99.98	534.80	24.08	15.15	1498.20	22.69	94.25
	25	750	99.99	314.20	12.09	15.16	748.73	11.35	93.86
	10	300	100.00	156.45	4.90	15.10	299.19	4.52	92.24
	0	0	100.00	14.26	0.04	15.18	0	0	0.00
115 V 60 Hz	100	3000	114.97	841.30	47.72	15.02	2998.28	45.04	94.38
	75	2250	114.98	676.50	36.01	15.13	2249.18	34.02	94.48
	50	1500	114.99	496.50	24.06	15.16	1498.95	22.72	94.43
	25	750	115.00	295.80	12.09	15.16	749.10	11.35	93.91
	10	300	115.01	141.45	4.91	15.10	299.19	4.52	92.05
	0	0	115.01	14.18	0.04	15.17	0	0	0.00
132 V 60 Hz	100	3000	131.95	783.10	47.87	15.09	2998.65	45.26	94.55
	75	2250	131.96	629.80	35.96	15.13	2248.80	34.01	94.59
	50	1500	131.97	460.80	24.05	15.16	1498.58	22.73	94.49
	25	750	131.98	278.00	12.10	15.16	749.10	11.36	93.85
	10	300	131.98	127.43	4.93	15.10	299.19	4.52	91.64
	0	0	131.98	14.16	0.04	15.17	0	0	0.00

9.7.5 Electrical Test Data at 9 V / 5 A

	Load Setting		Input Measurement			Load Measurement			Efficiency (%)
	% Load	Load (A)	V _{IN} (V _{RMS})	I _{IN} (A _{RMS})	P _{IN} (W)	V _{OUT} (V _{DC})	I _{OUT} (mA _{DC})	P _{OUT} (W)	
100 V 60 Hz	100	5000	99.96	921.00	48.04	8.94	4999.50	44.70	93.05
	75	3750	99.97	732.00	36.00	9.00	3748.88	33.73	93.69
	50	2500	99.98	538.00	24.17	9.08	2498.63	22.68	93.84
	25	1250	99.99	315.80	12.11	9.10	1248.75	11.37	93.86
	10	500	100.00	156.51	4.88	9.07	500.02	4.53	92.89
	0	0	100.01	13.36	0.02	9.09	0	0	0.00
115 V 60 Hz	100	5000	114.98	848.30	48.05	8.96	4999.50	44.82	93.27
	75	3750	114.99	678.60	36.02	9.02	3749.25	33.82	93.90
	50	2500	114.99	500.10	24.19	9.10	2499.00	22.74	93.99
	25	1250	115.00	297.60	12.12	9.11	1248.75	11.38	93.86
	10	500	115.01	141.38	4.89	9.07	500.02	4.53	92.64
	0	0	115.01	13.42	0.02	9.09	0	0	0.00
132 V 60 Hz	100	5000	131.96	787.50	48.06	8.98	4999.12	44.88	93.39
	75	3750	131.96	633.40	36.10	9.05	3749.25	33.92	93.96
	50	2500	131.97	464.30	24.21	9.10	2499.38	22.75	93.97
	25	1250	131.98	280.00	12.15	9.11	1249.13	11.38	93.70
	10	500	131.98	127.32	4.92	9.07	499.65	4.53	92.17
	0	0	131.99	13.53	0.02	9.09	0	0	0.00

9.7.6 Electrical Test Data at 5 V / 6.5 A

	Load Setting		Input Measurement			Load Measurement			Efficiency (%)
	% Load	Load (A)	V _{IN} (V _{RMS})	I _{IN} (A _{RMS})	P _{IN} (W)	V _{OUT} (V _{DC})	I _{OUT} (mA _{DC})	P _{OUT} (W)	
100 V 60 Hz	100	6500	99.97	728.00	35.84	5.05	6498.82	32.83	91.61
	75	4875	99.98	583.10	26.93	5.09	4874.59	24.82	92.16
	50	3250	99.99	428.80	18.06	5.15	3249.60	16.74	92.67
	25	1625	99.99	255.20	9.07	5.18	1623.49	8.40	92.67
	10	650	100.00	121.10	3.67	5.15	649.25	3.35	91.31
	0	0	100.00	14.03	0.03	5.15	0	0	0.00
115 V 60 Hz	100	6500	114.98	674.10	35.82	5.06	6499.20	32.91	91.88
	75	4875	114.99	541.60	26.89	5.10	4874.59	24.87	92.49
	50	3250	114.99	398.00	18.09	5.16	3249.60	16.78	92.77
	25	1625	115.00	239.36	9.10	5.18	1624.24	8.42	92.53
	10	650	115.01	109.25	3.69	5.16	649.62	3.35	90.88
	0	0	115.01	14.05	0.03	5.14	0	0	0.00
132 V 60 Hz	100	6500	131.96	628.60	35.88	5.08	6499.20	32.99	91.96
	75	4875	131.97	502.20	26.91	5.12	4874.21	24.93	92.65
	50	3250	131.97	373.80	18.14	5.17	3249.23	16.81	92.66
	25	1625	131.98	221.12	9.13	5.18	1623.86	8.42	92.25
	10	650	131.98	98.75	3.72	5.16	649.62	3.35	90.25
	0	0	131.98	14.13	0.04	5.15	0	0	0.00

9.8 ***Output Ripple Voltage***

Set-up: Use x1 voltage probe with 2 capacitors (0.1 μ F / 50 V ceramic and 47 μ F / 50 V E-cap) connected across the probe tip and ground as shown below. Oscilloscope was set to AC coupling with frequency bandwidth of 20 MHz. Ripple voltage was measured at the end of 100 m Ω output cable at room ambient temperature (25 $^{\circ}$ C).

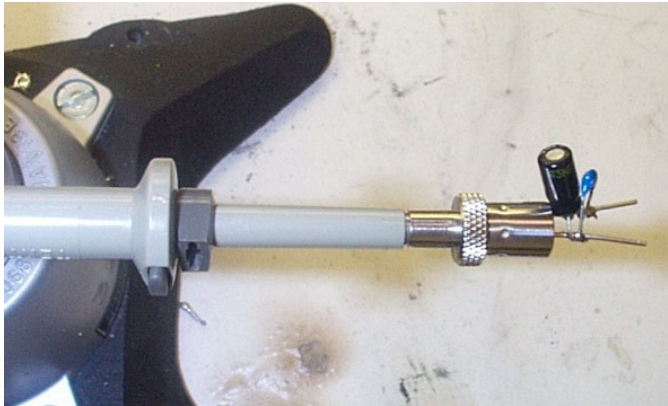

9.8.1 Output Ripple Voltage vs. Load at 100 VAC.

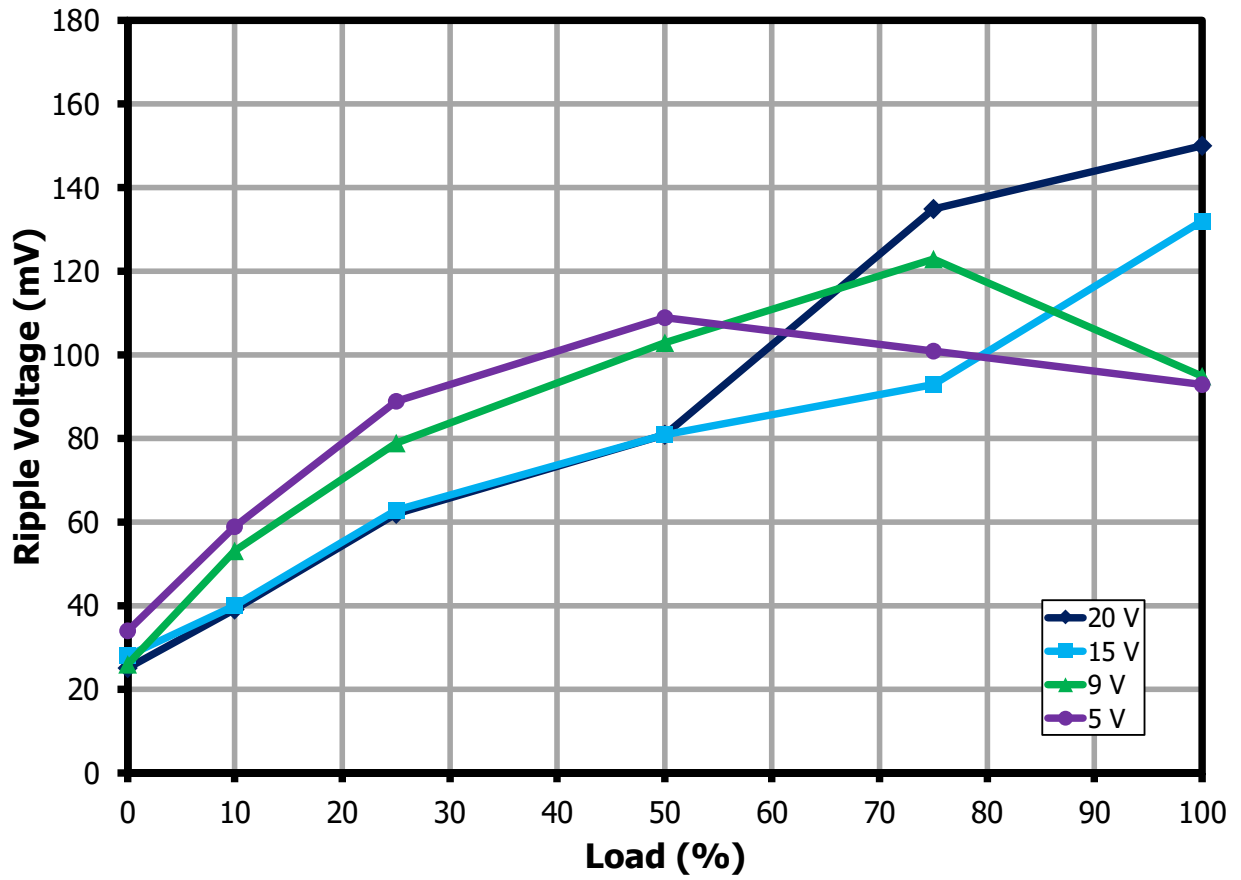

Figure 26 – Ripple Voltage vs. Load @ 100 VAC.

9.8.2 Output Ripple Voltage vs. Load at 132 VAC

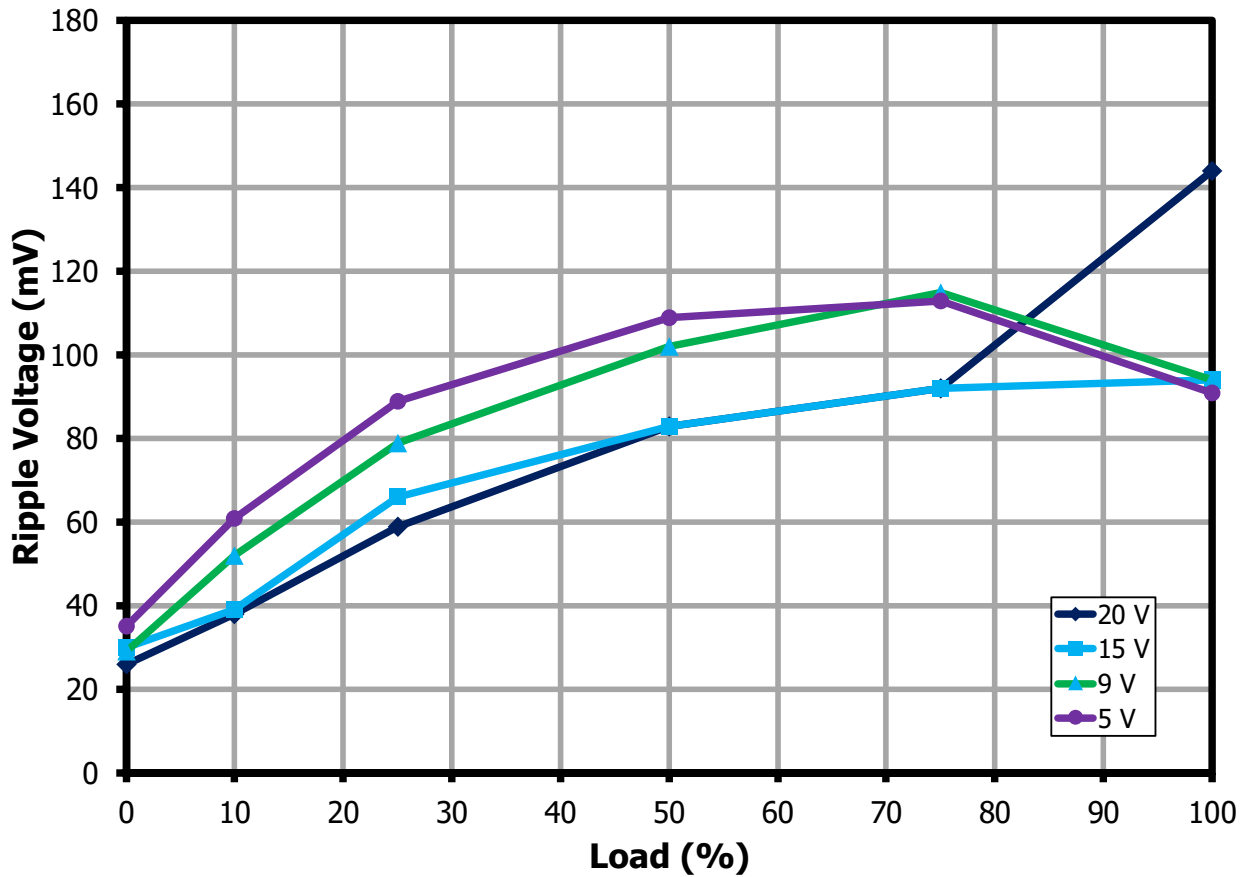

Figure 27 – Ripple Voltage vs. Load @ 132 VAC.

10 Thermal Performance

10.1 Thermal Scan at 25 °C Ambient

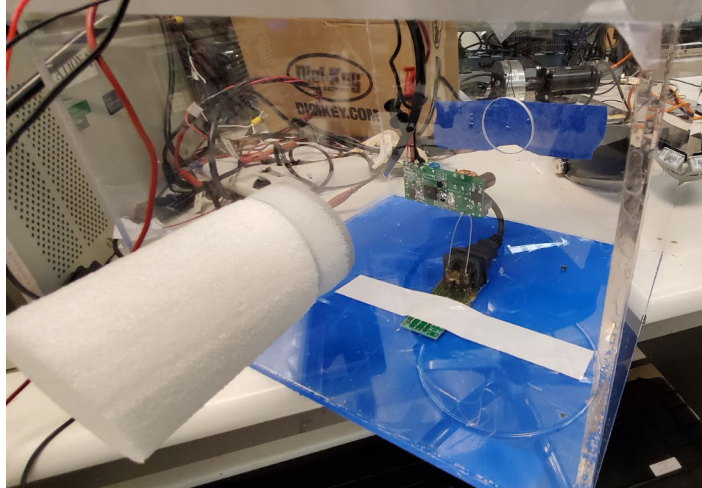

Figure 28 – Test Set-up Picture.

10.1.1 Thermal Scan Summary

Note: Tested using an IR Camera

100 VAC 60 Hz				
Component	Case Temperature (°C)			
	20 VDC, 3 A	15 VDC, 3 A	9 VDC, 5 A	5 VDC, 6.5 A
U1-InnoSwitch3-CP	76.6	60.5	74.3	67.9
D1-Snubber Diode	68.5	56.4	66.4	61.5
BR1-Bridge Diode	70	56.1	60	56
Q3-SR FET	70.1	57.7	76.5	79.3
D4-Sec Rectifier	69.7	52.7	73.2	75.3
TRF-TIW Wire	72	59.5	72.6	74.1
TRF-Core	67.2	55	64.7	61.6
L1-Input CMC	62.1	50	55.3	48.6
132VAC 60Hz				
Component	Case Temperature (°C)			
	20 VDC, 3 A	15 VDC, 3 A	9 VDC, 5 A	5 VDC, 6.5 A
U1-InnoSwitch3-CP	72.4	60.5	74.9	68.3
D1-Snubber Diode	66.7	56.4	67	62.1
BR1-Bridge Diode	60.9	56.1	53.9	51.6
Q3-SR FET	69.3	57.7	77.9	79.4
D4-Sec Rectifier	67.2	52.7	74.4	75.3
TRF-TIW Wire	70.8	59.5	73.6	72.8
TRF-Core	66.8	55	65.7	62
L1-Input CMC	56.3	50	52.4	49.2

10.1.2 100 VAC Input 20 V / 3 A

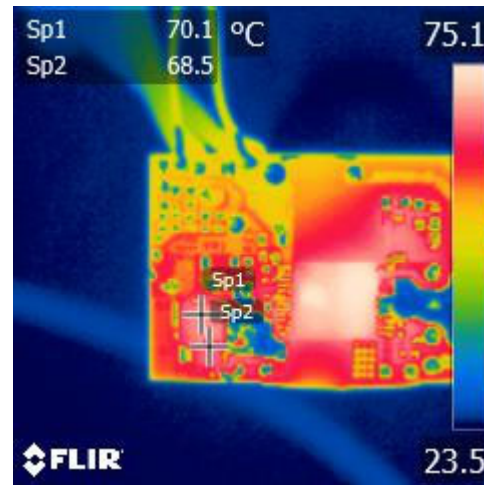
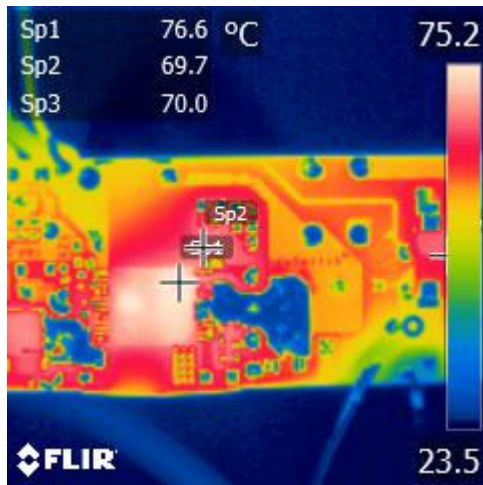

Figure 29 – Primary Bottom Side.

Component	Case Temperature (°C)
U1-InnoSwitch3-CP	76.6
D4-Sec Rectifier	68.5
BR1-Bridge Diode	70

Figure 30 – Secondary Bottom Side.

Component	Case Temperature (°C)
Q5-SR FET	70.1
D1-Snubber Diode	69.7

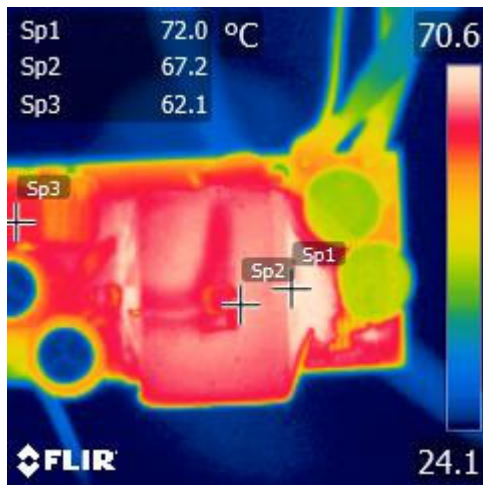

Figure 31 – Top Side.

Component	Case Temperature (°C)
TRF-TIW Wire	72
TRF-Core	67.2
L1- Input CMC	62.1

10.1.3 132 VAC Input 20 V / 3 A

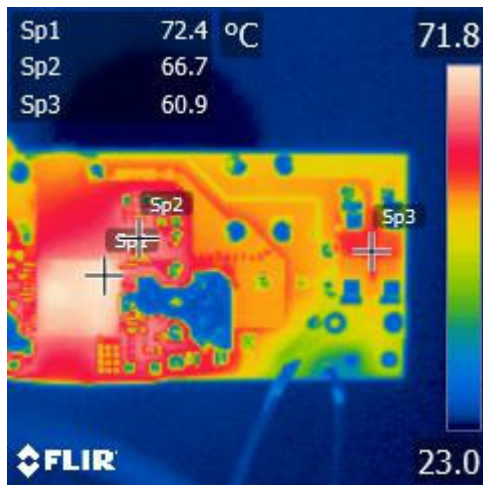

Figure 32 – Primary Bottom Side.

Component	Case Temperature (°C)
U1-InnoSwitch3-CP	72.4
D1-Snubber Diode	66.7
BR1-Bridge Diode	60.9

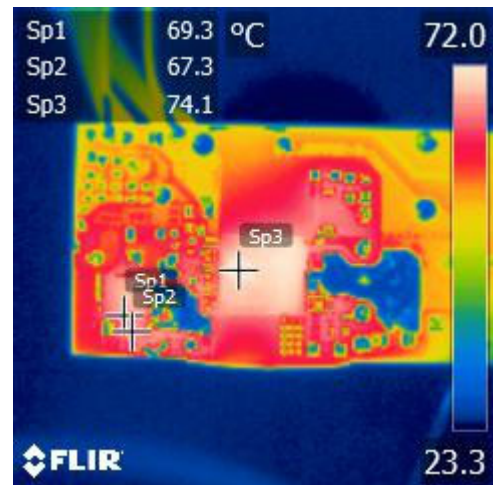

Figure 33 – Secondary Bottom Side.

Component	Case Temperature (°C)
Q5-SR FET	69.3
D4-Sec Rectifier	67.2

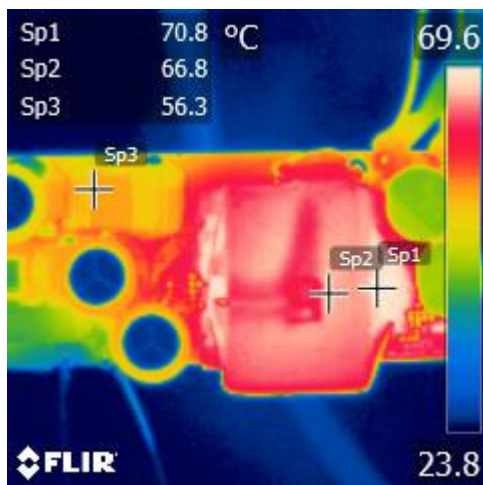

Figure 34 – Top Side.

Component	Case Temperature (°C)
TRF-TIW Wire	70.8
TRF-Core	66.8
L1- Input CMC	56.3

10.1.4 100 VAC Input 15 V / 3 A

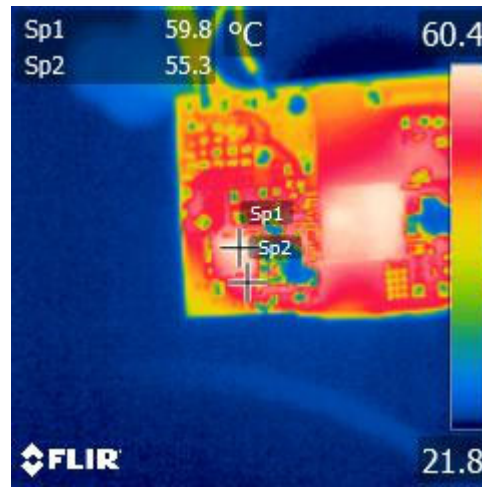
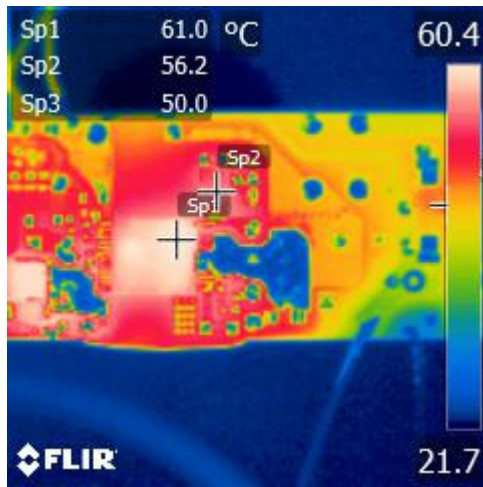

Figure 35 – Primary Bottom Side.

Component	Case Temperature (°C)
U1-InnoSwitch3-CP	60.5
D4-Sec Rectifier	56.4
BR1-Bridge Diode	56.1

Figure 36 – Secondary Bottom Side.

Component	Case Temperature (°C)
Q5-SR FET	57.7
D1-Snubber Diode	52.7

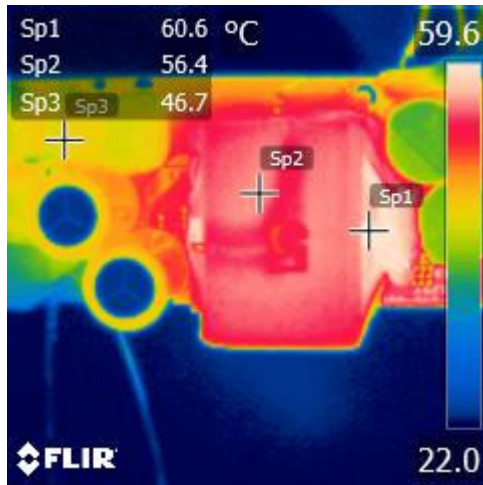

Figure 37 – Top Side.

Component	Case Temperature (°C)
TRF-TIW Wire	59.5
TRF-Core	55
L1- Input CMC	50

10.1.5 132 VAC Input 15 V / 3 A

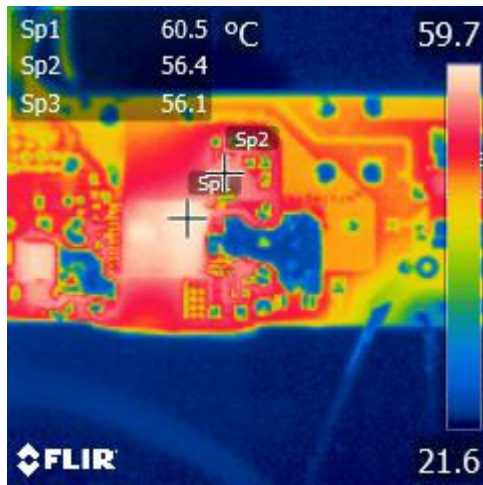

Figure 38 – Primary Bottom Side.

Component	Case Temperature (°C)
U1-InnoSwitch3-CP	60.5
D1-Snubber Diode	56.4
BR1-Bridge Diode	56.1

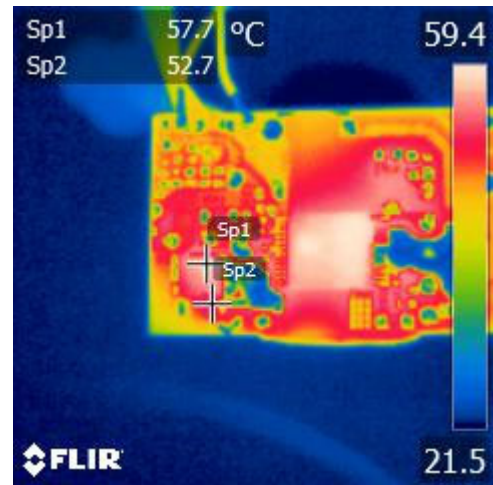

Figure 39 – Secondary Bottom Side.

Component	Case Temperature (°C)
Q3-SR FET	57.7
D4-Sec Rectifier	52.7

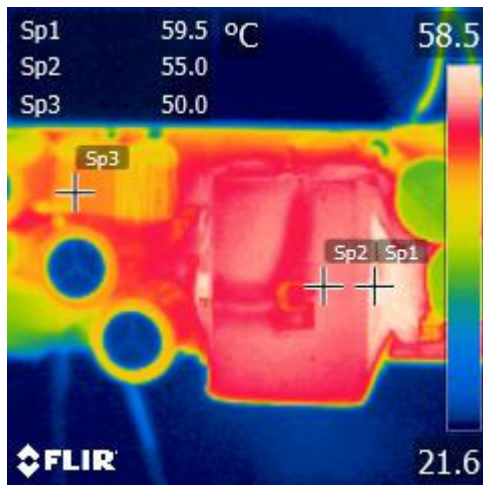

Figure 40 – Top Side.

Component	Case Temperature (°C)
TRF-TIW Wire	59.5
TRF-Core	55
L1- Input CMC	50

10.1.6 100 VAC Input 9 V / 5 A

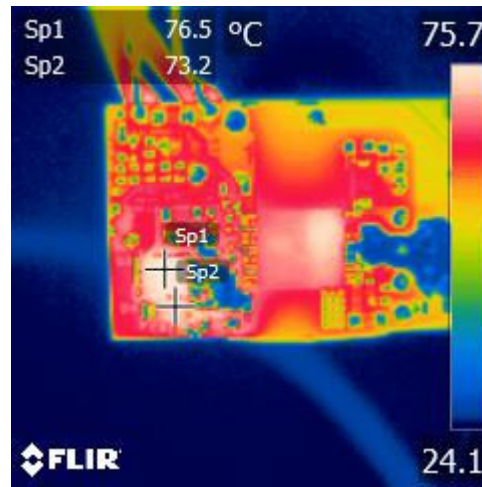
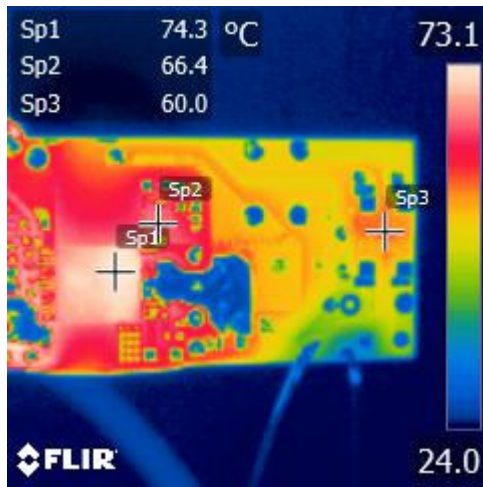

Figure 41 – Primary Bottom Side.

Component	Case Temperature (°C)
U1-InnoSwitch3-CP	74.3
D1-Snubber Diode	66.4
BR1-Bridge Diode	60

Figure 42 – Secondary Bottom Side.

Component	Case Temperature (°C)
Q5-SR FET	76.5
D4-Sec Rectifier	73.2

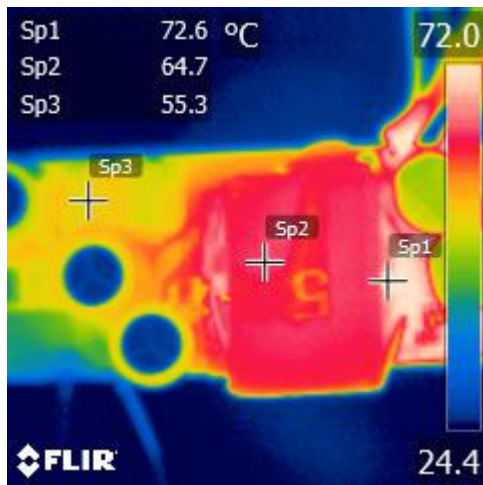

Figure 43 – Top Side.

Component	Case Temperature (°C)
TRF-TIW Wire	72.6
TRF-Core	64.7
L1-Input CMC	55.3

10.1.7 132 VAC Input 9 V / 5 A

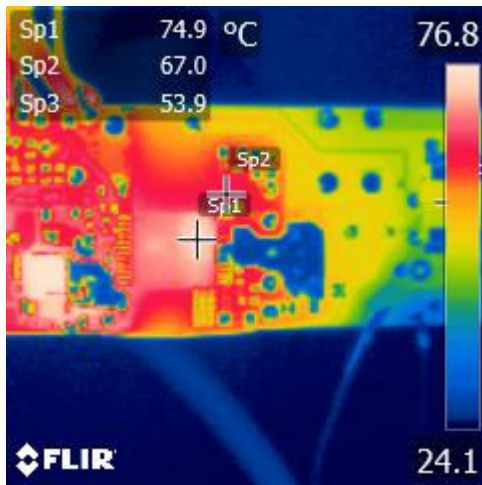

Figure 44 – Primary Bottom Side.

Component	Case Temperature (°C)
U1-InnoSwitch3-CP	74.9
D1-Snubber Diode	67
BR1-Bridge Diode	53.9

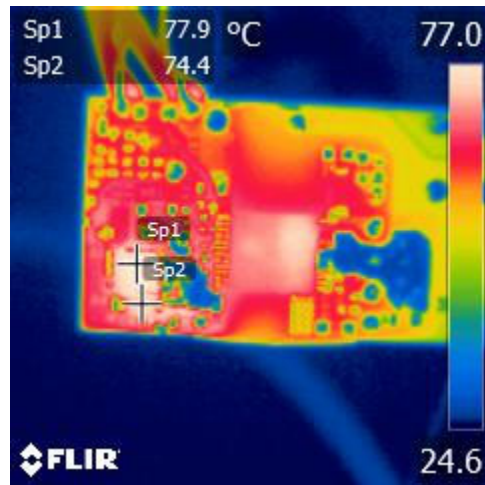

Figure 45 – Secondary Bottom Side.

Component	Case Temperature (°C)
Q3-SR FET	77.9
D4-Sec Rectifier	74.4

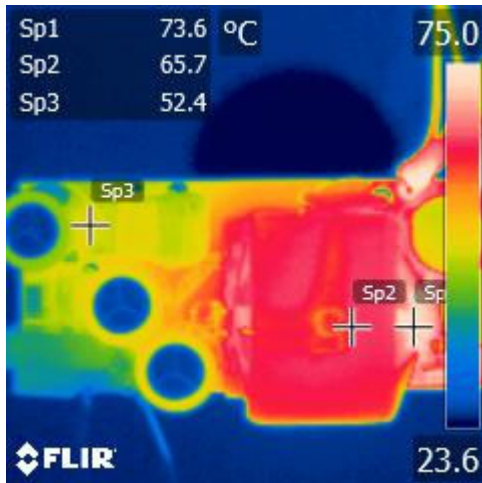

Figure 46 – Top Side.

Component	Case Temperature (°C)
TRF-TIW Wire	73.6
TRF-Core	65.7
L1-Input CMC	52.4

10.1.8 100 VAC Input 5 V / 6.5 A

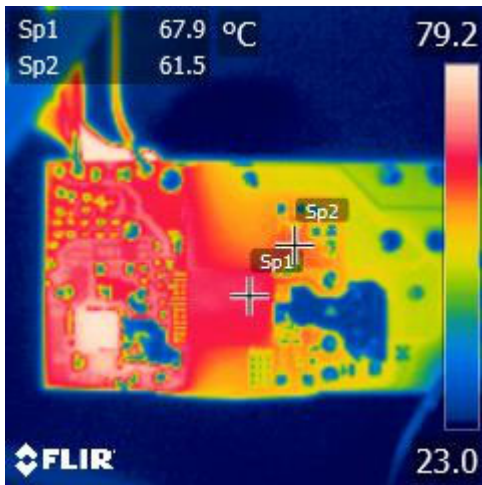

Figure 47 – Primary Bottom Side.

Component	Case Temperature (°C)
U1-InnoSwitch3-CP	67.9
D1-Snubber Diode	61.5
BR1-Bridge Diode	56

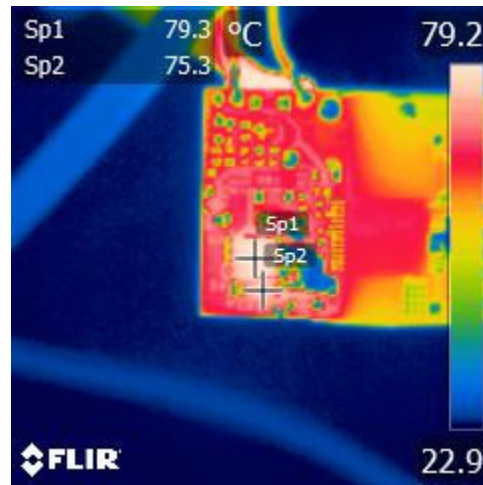

Figure 48 – Secondary Bottom Side.

Component	Case Temperature (°C)
Q3-SR FET	79.3
D4-Sec Rectifier	75.3

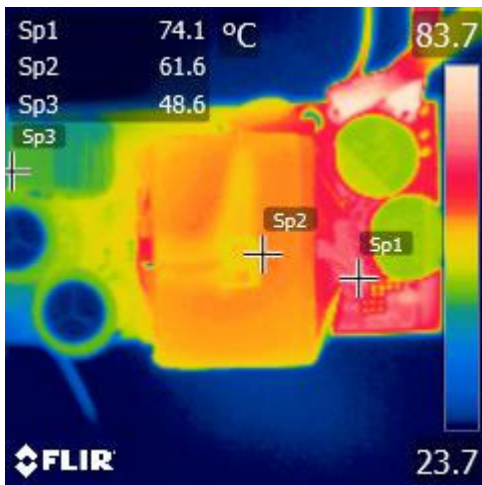

Figure 49 – Top Side.

Component	Case Temperature (°C)
TRF-TIW Wire	74.1
TRF-Core	61.6
L1-Input CMC	48.6

10.1.9 132 VAC Input 5 V / 6.5 A

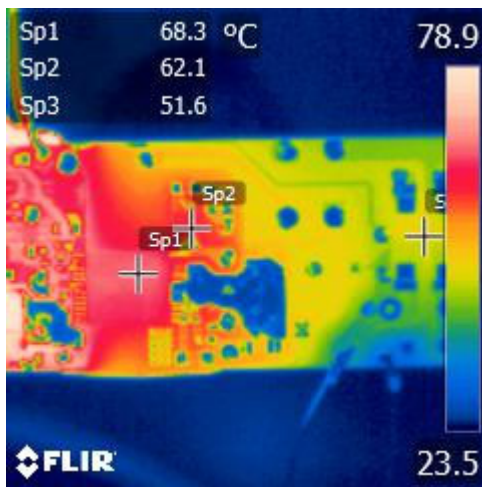

Figure 50 – Primary Bottom Side.

Component	Case Temperature (°C)
U1-InnoSwitch3-CP	68.3
D1-Snubber Diode	62.1
BR1-Bridge Diode	51.6

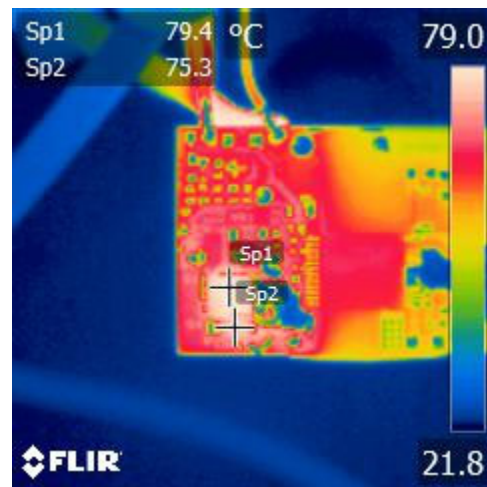

Figure 51 – Secondary Bottom Side.

Component	Case Temperature (°C)
Q3-SR FET	79.4
D4-Sec Rectifier	75.3

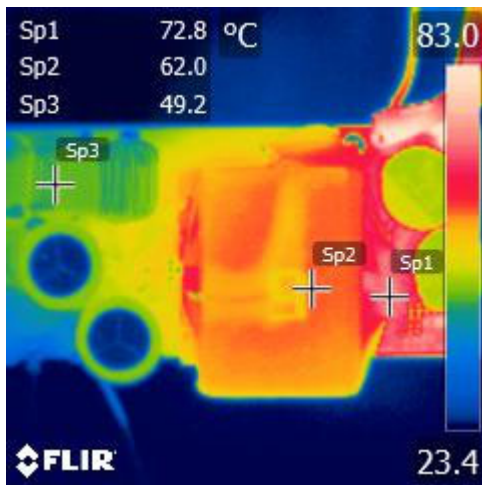

Figure 52 –Top Side.

Component	Case Temperature (°C)
TRF-TIW Wire	72.8
TRF-Core	62
L1-Input CMC	49.2

10.2 Thermal Performance at 50 °C Ambient

10.2.1 Set-up Picture



Figure 53 – Tested using the environmental test chamber.

The DUT is placed inside enclosure to prevent airflow.

10.2.2 Thermal Test Summary at 50 °C Ambient

Input / Output Condition	Temperature (°C)							
	AMB	U1	Q3	D1	C2	T1	D4	BR1
100 VAC 20 V - 3 A	54	98.4	93.4	90.7	84.1	89.2	88.8	89.8
132 VAC 20 V - 3 A	52.2	90.7	90.1	84.7	78.2	86.3	86.1	79.7
100 VAC 9 V - 5 A	52.6	94.5	95	85.9	77.6	85.1	89.5	79.9
132 VAC 9 V - 5 A	52.7	95.1	96.3	85.3	76.6	86.4	90.5	75.1
100 VAC 5 V - 6.5 A	52.8	88.9	98.2	81.4	74	84.9	91.2	73.4
132 VAC 5 V - 6.5 A	52.6	89.7	99.1	81	73.3	85.3	92.2	69.9

10.2.3 Thermal Data at 50 °C Ambient

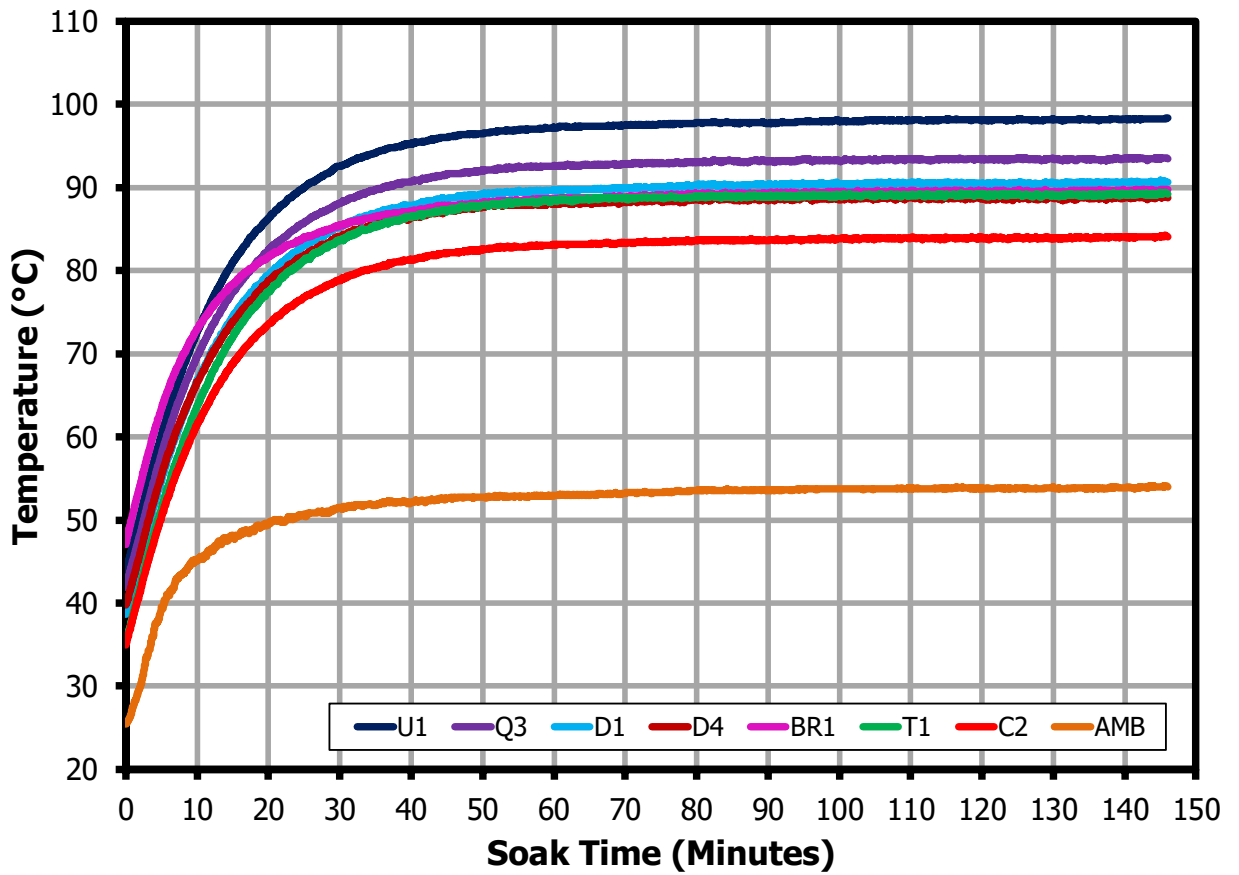

Figure 54 – Thermal Profile at 100 VAC, 20 V / 3 A.

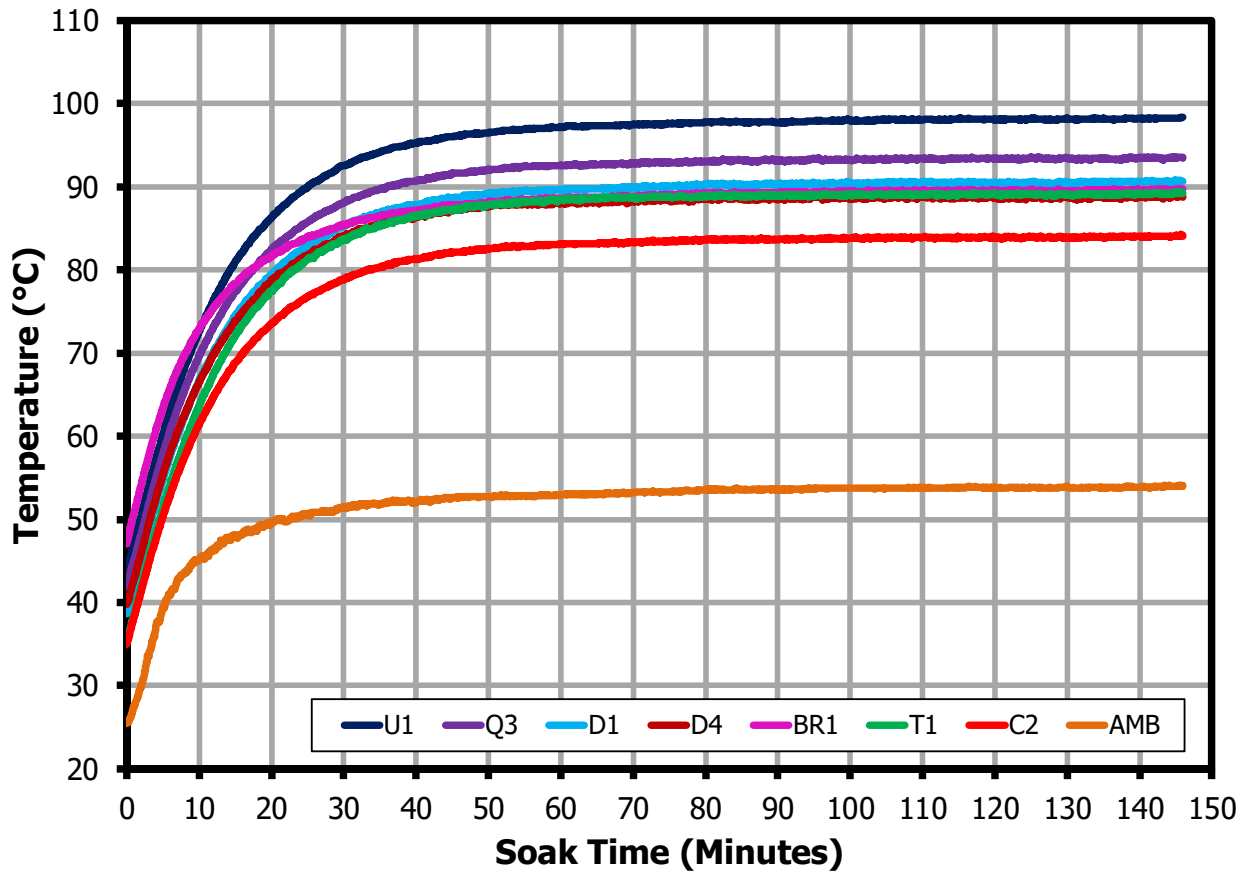

Figure 55 – Thermal Profile at 132 VAC, 20 V / 3 A.

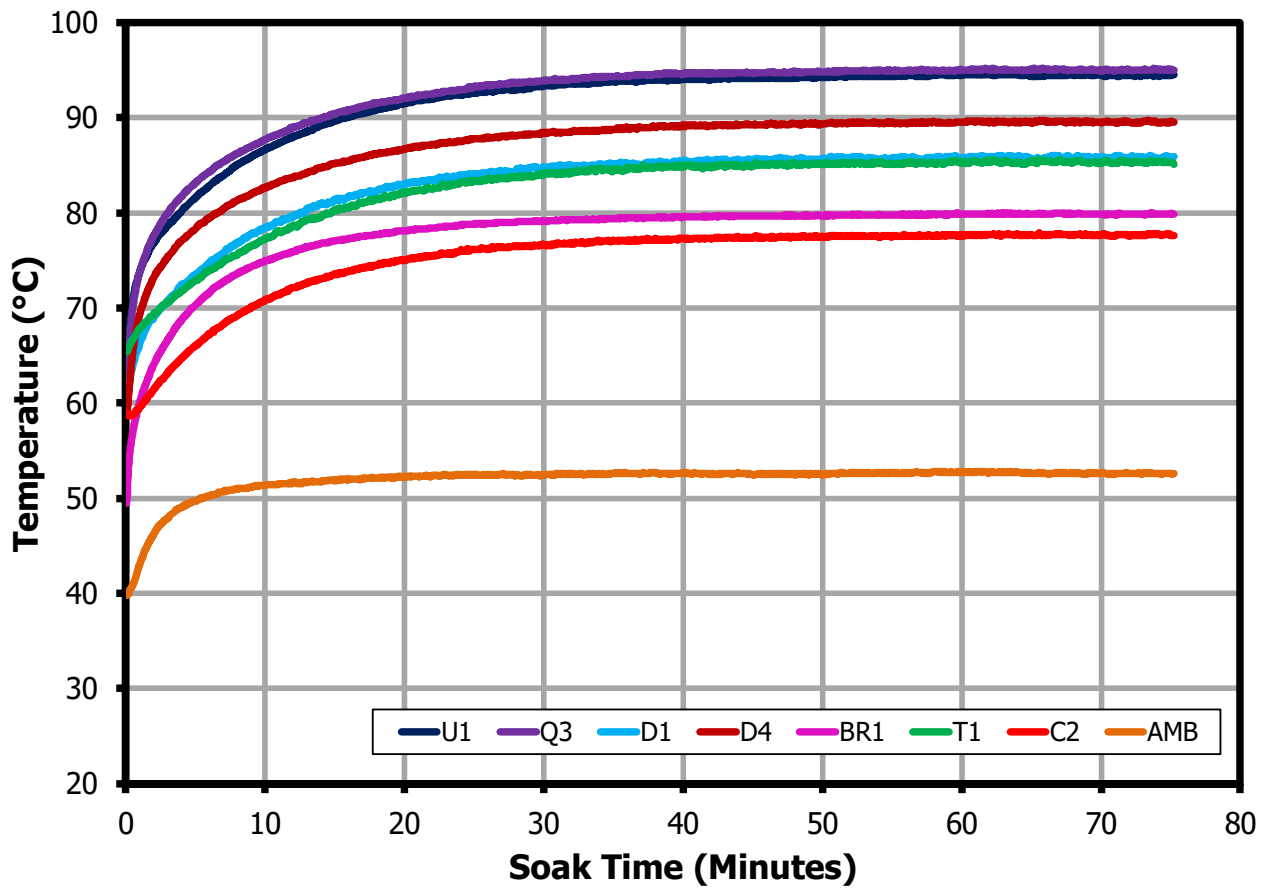

Figure 56 – Thermal Profile at 100 VAC, 9 V / 5 A.

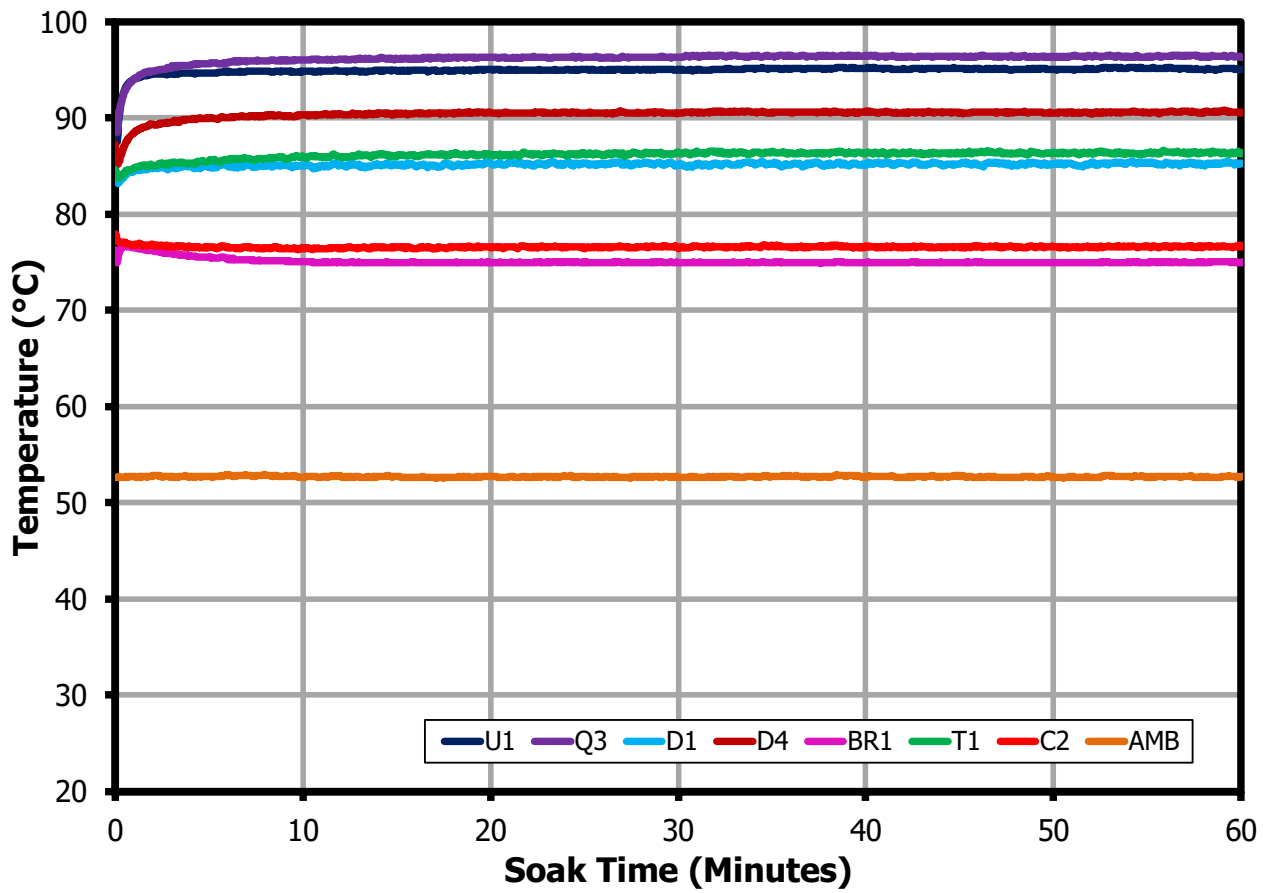

Figure 57 – Thermal Profile at 132 VAC, 9 V / 5 A.

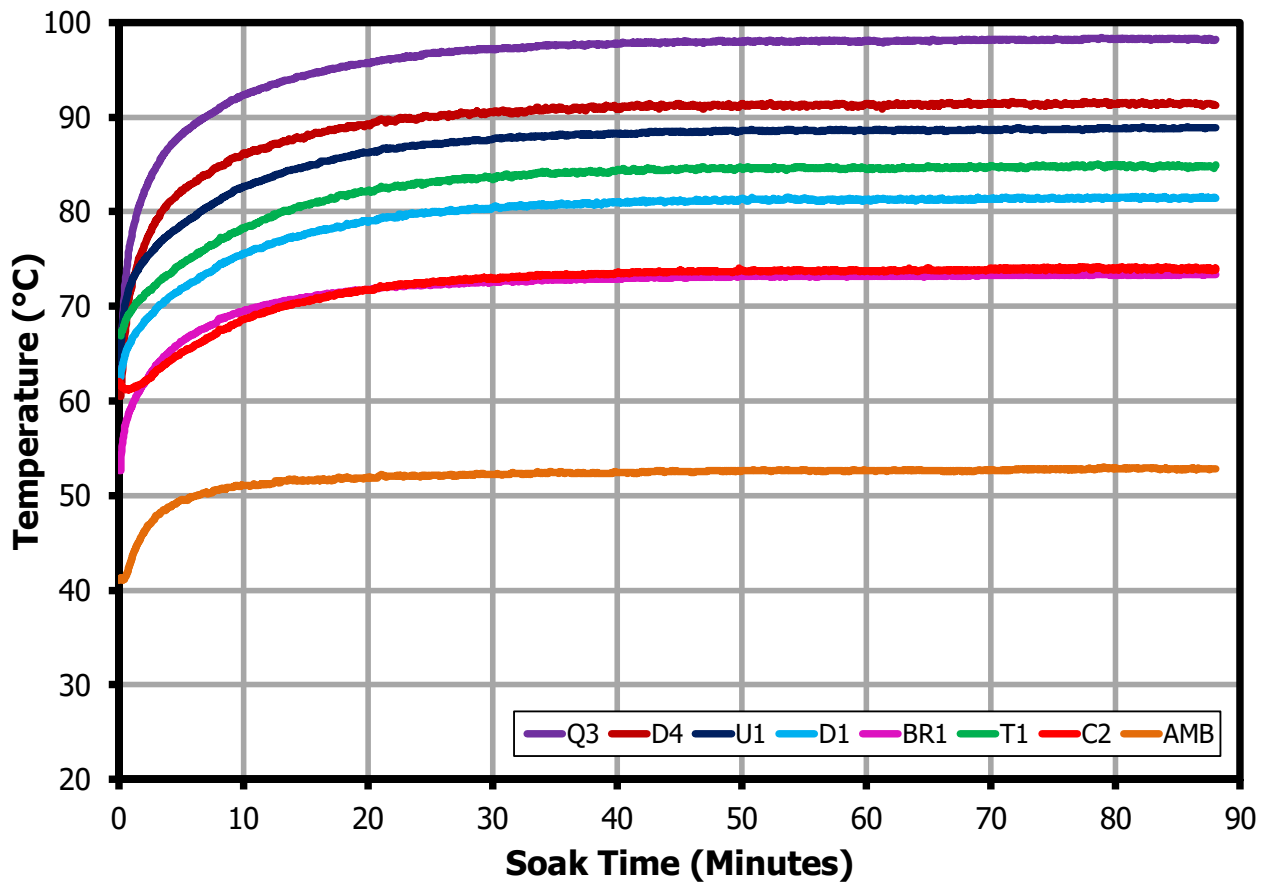

Figure 58 – Thermal Profile at 100 VAC, 5 V / 6.5 A.

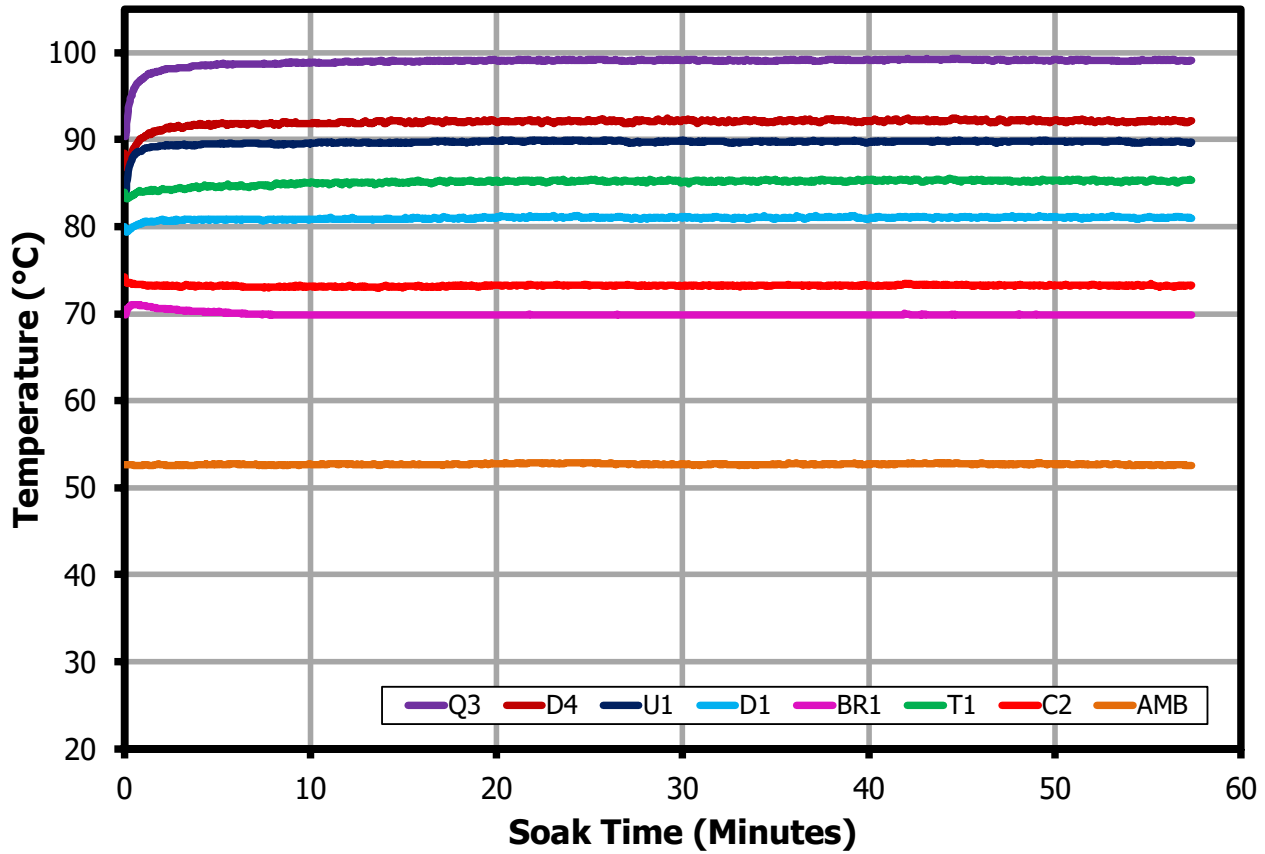

Figure 59 – Thermal Profile at 132 VAC, 5 V / 6.5 A.

11 Waveforms

11.1 Primary Drain Voltage and Current Waveform

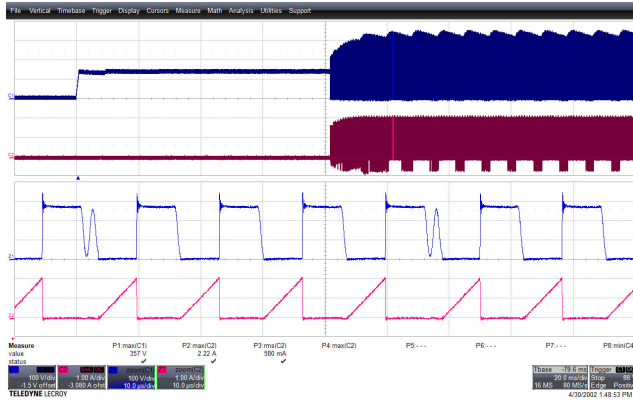

Figure 60 – 100 VAC 60 Hz, 20 V Full Load Start-up.
 CH1(Blue): V_{DS} , 100 V / div., 20 ms / div.
 CH2(Pink): I_{DS} , 1 A / div.
 $V_{DS} = 357$ V, $I_{DS} = 2.22$ A.

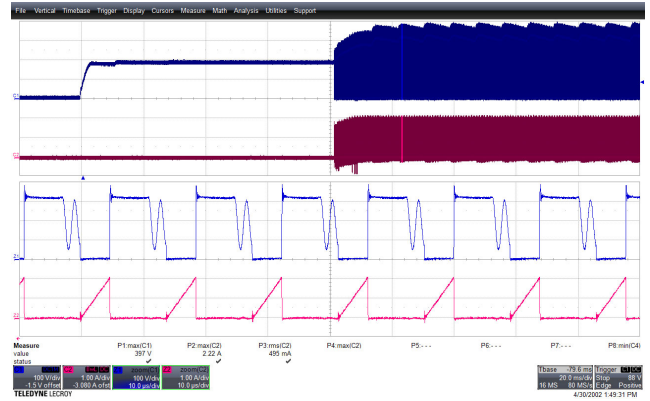

Figure 61 – 132 VAC 60 Hz, 20 V Full Load Start-up.
 CH1(Blue): V_{DS} , 100 V / div., 20 ms / div.
 CH2(Pink): I_{DS} , 1 A / div.
 $V_{DS} = 497$ V, $I_{DS} = 2.22$ A.

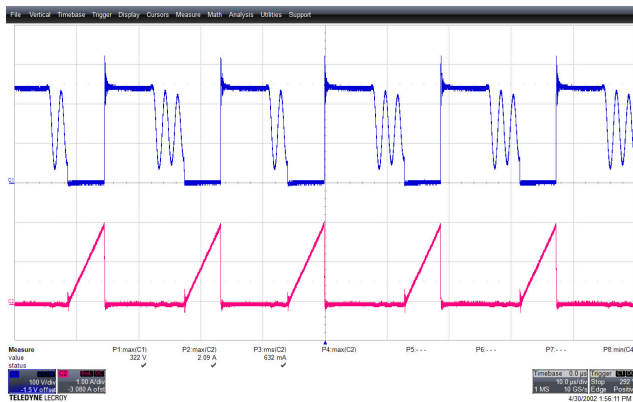

Figure 62 – 100 VAC 60 Hz, 20 V Full Load Normal.
 CH1(Blue): V_{DS} , 100 V / div., 20 ms / div.
 CH2(Pink): I_{DS} , 1 A / div.
 $V_{DS} = 322$ V, $I_{DS} = 2.09$ A.

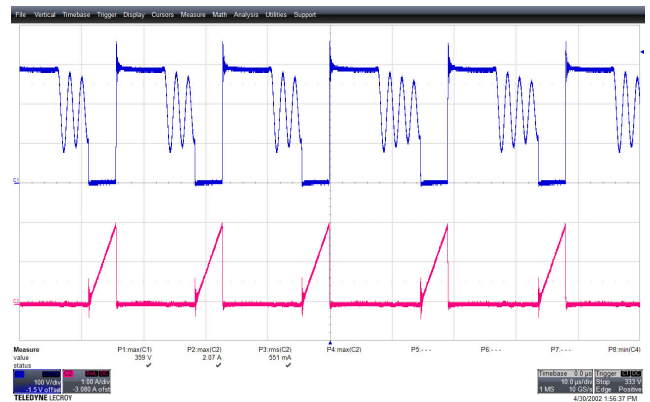

Figure 63 – 132 VAC 60 Hz, 20 V Full Load Normal.
 CH1(Blue): V_{DS} , 100 V / div., 20 ms / div.
 CH2(Pink): I_{DS} , 1 A / div.
 $V_{DS} = 359$ V, $I_{DS} = 2.07$ A.

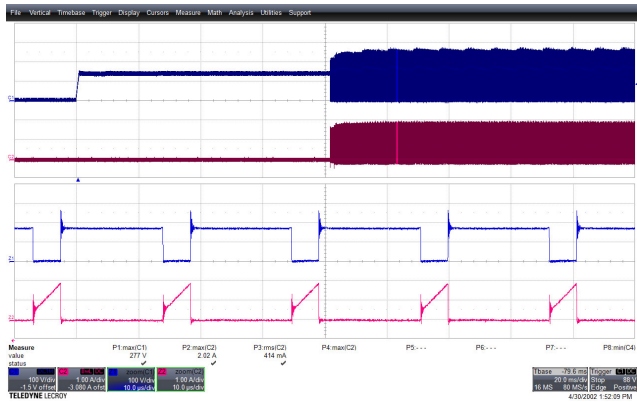

Figure 64 – 100 VAC 60 Hz, 5 V Full Load Start-up.
 CH1(Blue): V_{DS} , 100 V / div., 20 ms / div.
 CH2(Pink): I_{DS} , 1 A / div.
 $V_{DS} = 277$ V, $I_{DS} = 2.02$ A.

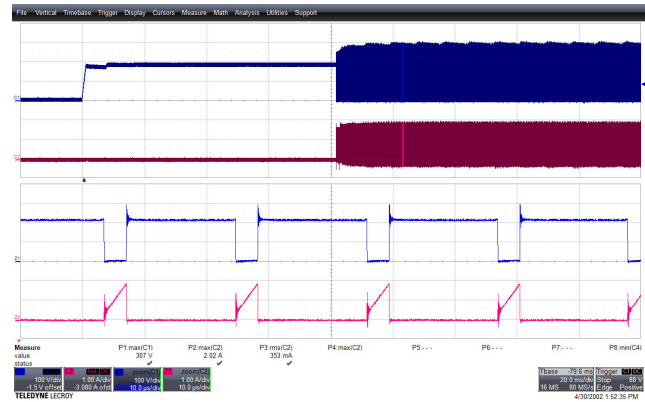

Figure 65 – 132 VAC 60 Hz, 5 V Full Load Start-up.
 CH1(Blue): V_{DS} , 100 V / div., 20 ms / div.
 CH2(Pink): I_{DS} , 1 A / div.
 $V_{DS} = 307$ V, $I_{DS} = 2.02$ A.

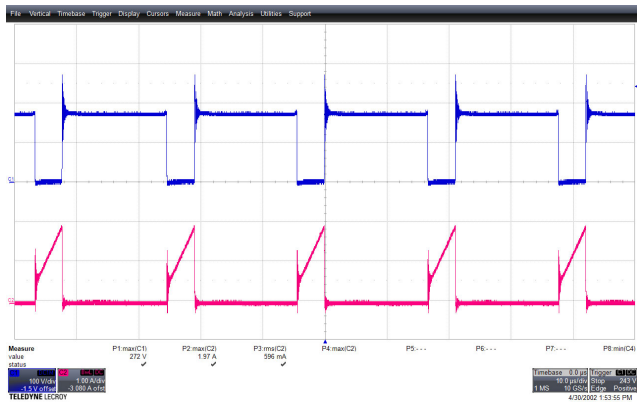

Figure 66 – 100 VAC 60 Hz, 5 V Full Load Normal.
 CH1(Blue): V_{DS} , 100 V / div., 20 ms / div.
 CH2(Pink): I_{DS} , 1 A / div.
 $V_{DS} = 272$ V, $I_{DS} = 1.97$ A.

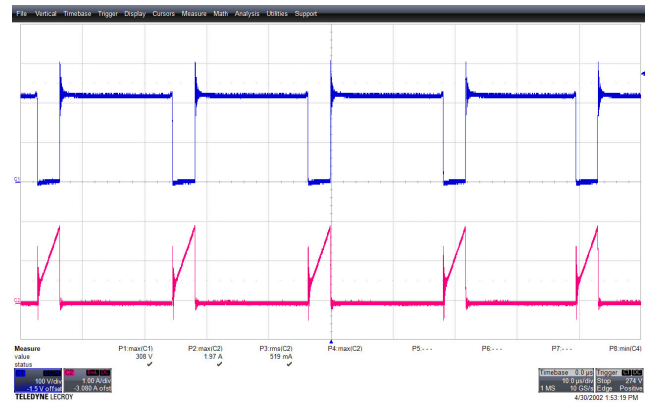

Figure 67 – 132 VAC 60 Hz, 5 V Full Load Normal.
 CH1(Blue): V_{DS} , 100 V / div., 20 ms / div.
 CH2(Pink): I_{DS} , 1 A / div.
 $V_{DS} = 308$ V, $I_{DS} = 1.97$ A.

11.2 **SR FET Drain Voltage Waveform**

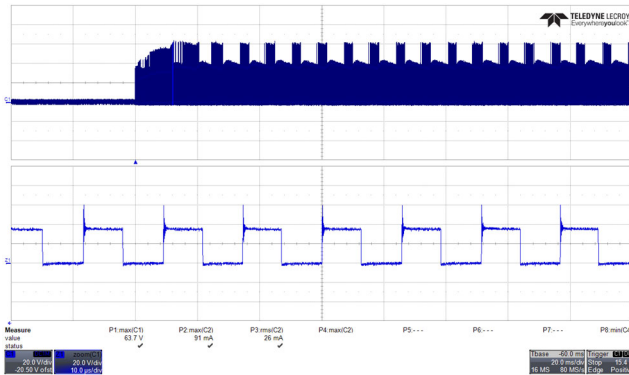

Figure 68 – 100 VAC 60 Hz, 20 V Full Load Start-up.
CH1(Blue): V_{DS} , 20 V / div., 20 ms / div.
 $V_{DS} = 63.7$ V.

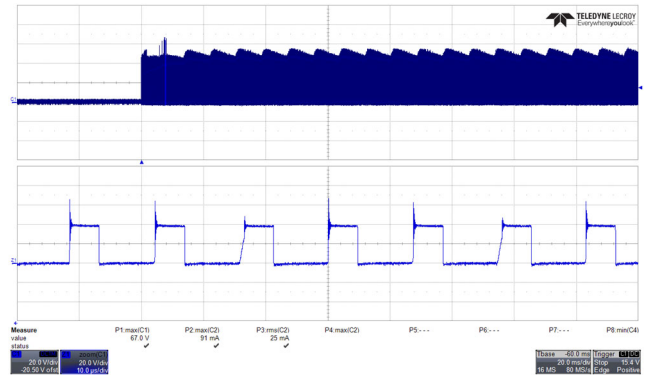

Figure 69 – 132 VAC 60 Hz, 20 V Full Load Start-up.
CH1(Blue): V_{DS} , 20 V / div., 20 ms / div.
 $V_{DS} = 67$ V.

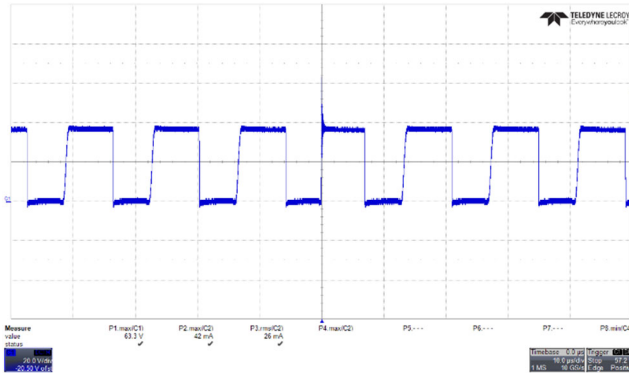

Figure 70 – 100 VAC 60 Hz, 20 V Full Load Normal.
CH1(Blue): V_{DS} , 20 V / div., 20 ms / div.
 $V_{DS} = 63.3$ V.

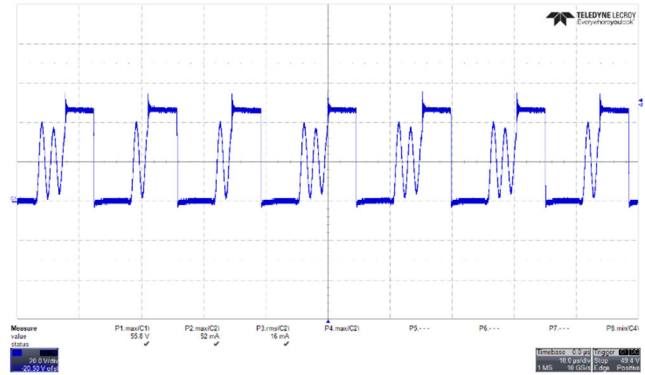

Figure 71 – 132 VAC 60 Hz, 20 V Full Load Start-up.
CH1(Blue): V_{DS} , 20 V / div., 20 ms / div.
 $V_{DS} = 55.8$ V.

11.3 Start-up Profile

Tested using an E-load set at constant current mode.

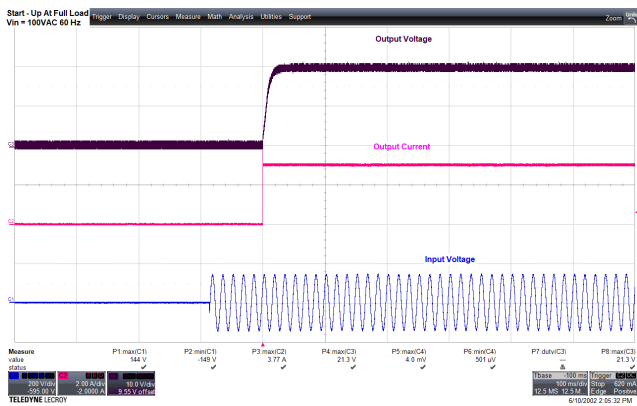

Figure 72 – 100 VAC 60 Hz, 20 V Full Load Start-up.
 CH1(Blue): V_{IN} , 200 V / div., 100 ms / div.
 CH2(Pink): I_{OUT} , 2 A / div.
 CH3(Purple): V_{OUT} , 10 V / div.

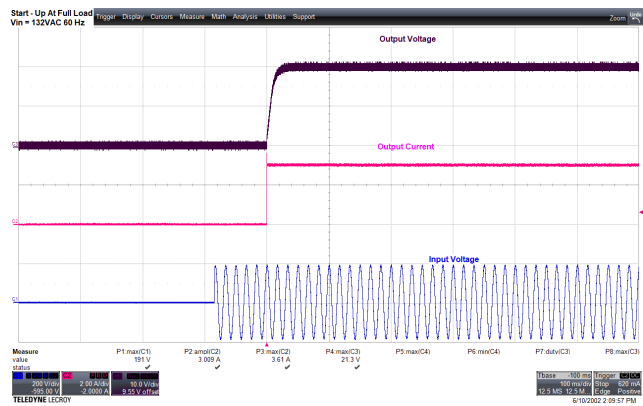

Figure 73 – 132 VAC 60 Hz, 20 V Full Load Start-up.
 CH1(Blue): V_{IN} , 200 V / div., 100 ms / div.
 CH2(Pink): I_{OUT} , 2 A / div.
 CH3(Purple): V_{OUT} , 2 V / div.

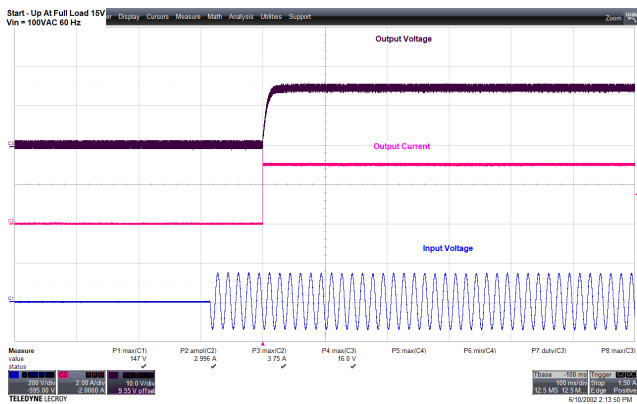

Figure 74 – 100 VAC 60 Hz, 15 V Full Load Start-up.
 CH1(Blue): V_{IN} , 200 V / div., 100 ms / div.
 CH2(Pink): I_{OUT} , 2 A / div.
 CH3(Purple): V_{OUT} , 10 V / div.

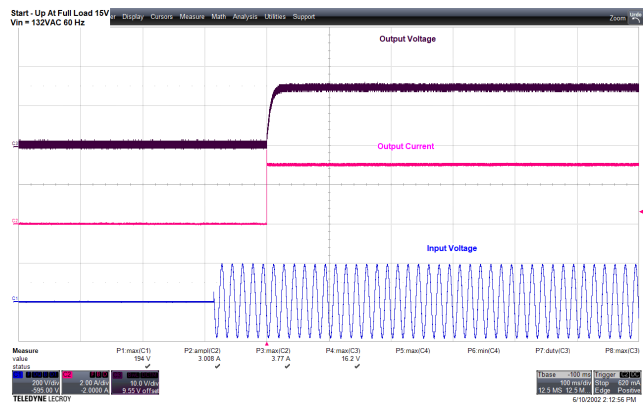

Figure 75 – 132 VAC 60 Hz, 15 V Full Load Start-up.
 CH1(Blue): V_{IN} , 200 V / div., 100 ms / div.
 CH2(Pink): I_{OUT} , 2 A / div.
 CH3(Purple): V_{OUT} , 2 V / div.

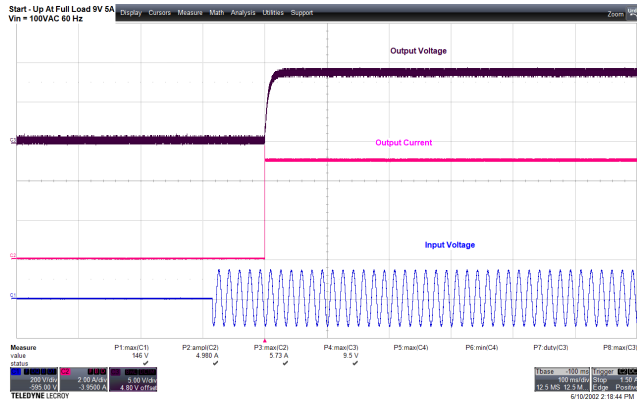

Figure 76 – 100 VAC 60 Hz, 9 V Full Load Start-up.
 CH1(Blue): V_{IN} , 200 V / div., 100 ms / div.
 CH2(Pink): I_{OUT} , 2 A / div.
 CH3(Purple): V_{OUT} , 10 V / div.

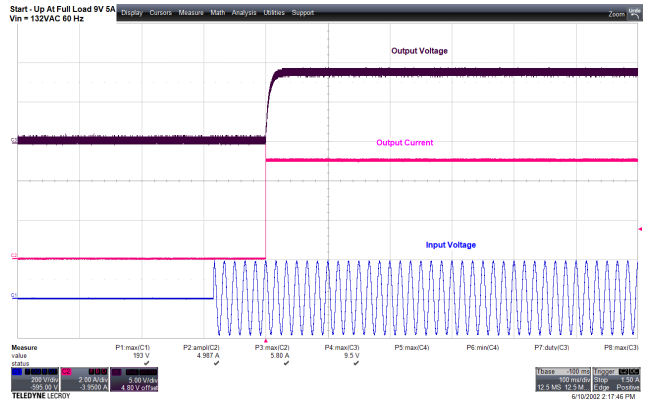

Figure 77 – 132 VAC 60 Hz, 9 V Full Load Start-up.
 CH1(Blue): V_{IN} , 200 V / div., 100 ms / div.
 CH2(Pink): I_{OUT} , 2 A / div.
 CH3(Purple): V_{OUT} , 2 V / div.

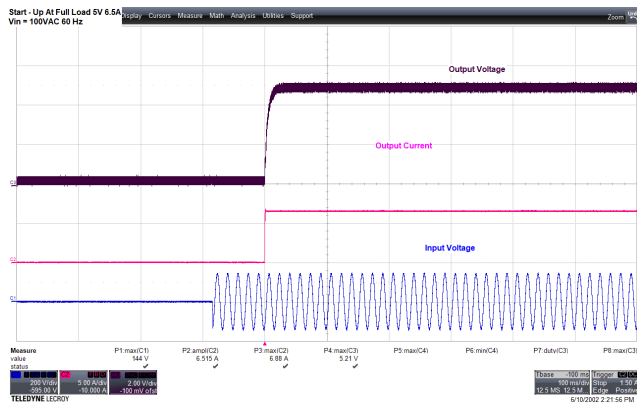

Figure 78 – 100 VAC 60 Hz, 5 V Full Load Start-up.
 CH1(Blue): V_{IN} , 200 V / div., 100 ms / div.
 CH2(Pink): I_{OUT} , 2 A / div.
 CH3(Purple): V_{OUT} , 10 V / div.

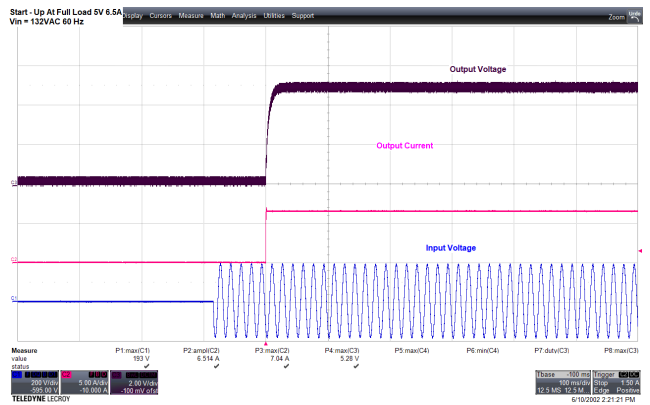

Figure 79 – 132 VAC 60 Hz, 5 V Full Load Start-up.
 CH1(Blue): V_{IN} , 200 V / div., 100 ms / div.
 CH2(Pink): I_{OUT} , 2 A / div.
 CH3(Purple): V_{OUT} , 2 V / div.

11.4 Transient Load Response

Tested using an E-Load set at dynamin constant current loading.

11.4.1 Transient Load at $V_{OUT} = 20\text{ V}$

Set-up: Duty Cycle = 50%, Frequency = 100 Hz, Slew Rate = 200 mA / μs

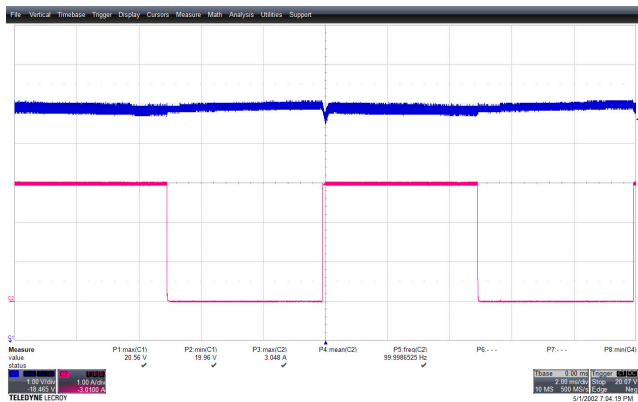

Figure 80 – 100 VAC 60 Hz, 0-3 A Transient Load.
 CH1(Blue): V_{OUT} , 1 V / div., 2 ms / div.
 CH2(Pink): I_{OUT} , 1 A / div.
 $V_{OUT(MAX)} = 20.56\text{ V}$, $V_{OMIN} = 19.96\text{ V}$.

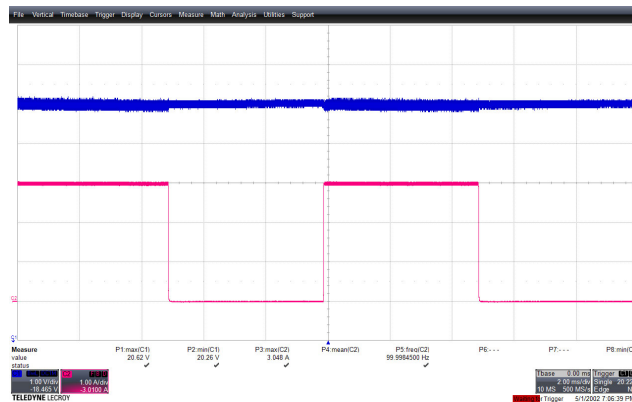

Figure 81 – 132 VAC 60 Hz, 0-3 A Transient Load.
 CH1(Blue): V_{OUT} , 1 V / div., 2 ms / div.
 CH2(Pink): I_{OUT} , 1 A / div.
 $V_{OUT(MAX)} = 20.62\text{ V}$, $V_{OMIN} = 20.26\text{ V}$.

11.4.2 Transient Load at $V_{OUT} = 15\text{ V}$

Set-up: Duty Cycle = 50%, Frequency = 100 Hz, Slew Rate = 200 mA / μs

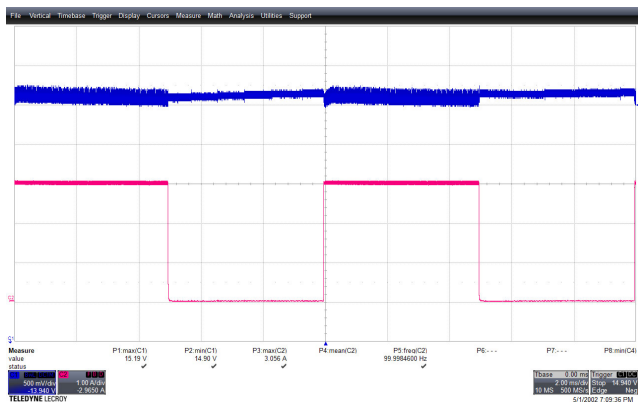

Figure 82 – 100 VAC 60 Hz, 0-3 A Transient Load.
 CH1(Blue): V_{OUT} , 1 V / div., 2 ms / div.
 CH2(Pink): I_{OUT} , 500 mA / div.
 $V_{OUT(MAX)} = 15.19\text{ V}$, $V_{OMIN} = 14.9\text{ V}$.

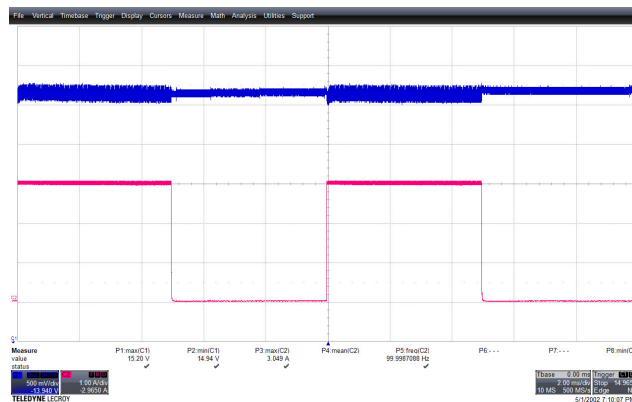

Figure 83 – 132 VAC 60 Hz, 0-3 A Transient Load.
 CH1(Blue): V_{OUT} , 1 V / div., 2 ms / div.
 CH2(Pink): I_{OUT} , 500 mA / div.
 $V_{OUT(MAX)} = 15.20\text{ V}$, $V_{OMIN} = 14.94\text{ V}$.

11.4.3 Transient Load at $V_{OUT} = 9\text{ V}$

Set-up: Duty Cycle = 50%, Frequency = 100 Hz, Slew Rate = 200 mA / us

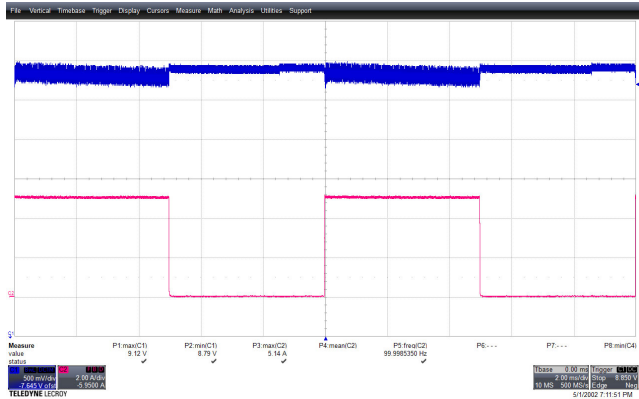

Figure 84 – 100 VAC 60 Hz, 0-5 A Transient Load.
 CH1(Blue): V_{OUT} , 0.5 V / div., 2 ms / div.
 CH2(Pink): I_{OUT} , 2 A / div.
 $V_{OUT(MAX)} = 9.12\text{ V}$, $V_{OMIN} = 8.79\text{ V}$.

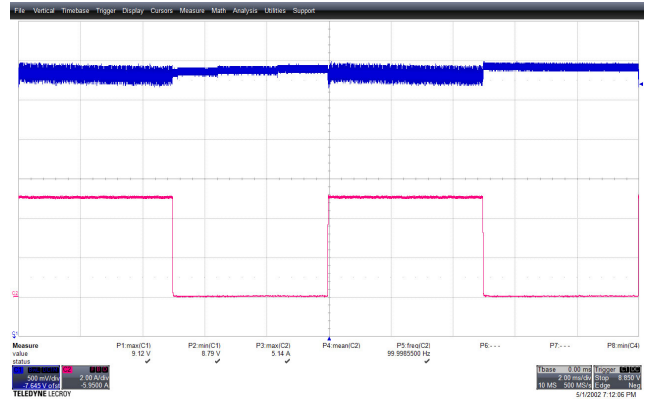

Figure 85 – 132 VAC 60 Hz, 0-5 A Transient Load.
 CH1(Blue): V_{OUT} , 0.5 V / div., 2 ms / div.
 CH2(Pink): I_{OUT} , 2 A / div.
 $V_{OUT(MAX)} = 9.12\text{ V}$, $V_{OMIN} = 8.79\text{ V}$.

11.4.4 Transient Load at $V_{OUT} = 5\text{ V}$

Set-up: Duty Cycle = 50%, Frequency = 100 Hz, Slew Rate = 200 mA / us

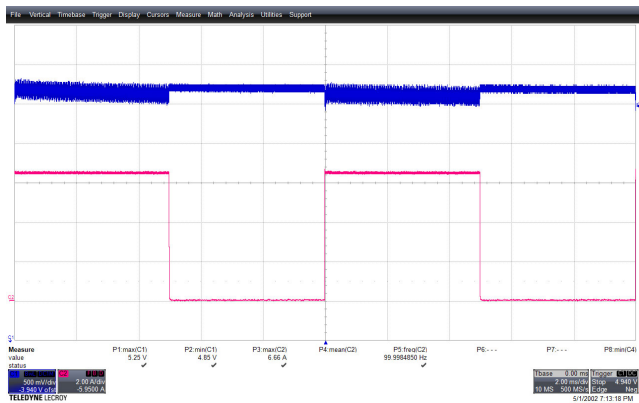

Figure 86 – 100 VAC 60 Hz, 0-6.5 A Transient Load.
 CH1(Blue): V_{OUT} , 0.5 V / div., 2 ms / div.
 CH2(Pink): I_{OUT} , 2 A / div.
 $V_{OUT(MAX)} = 5.25\text{ V}$, $V_{OMIN} = 4.85\text{ V}$.

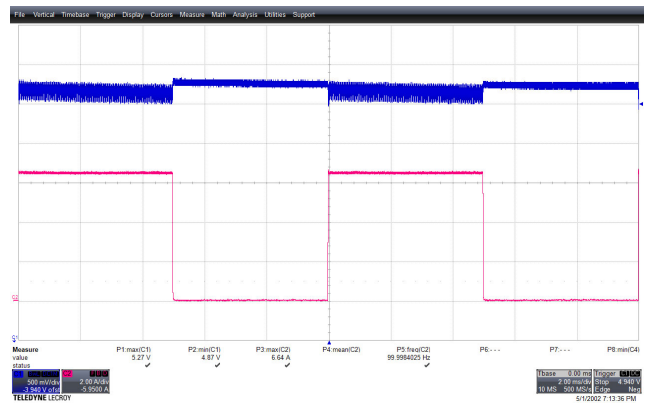

Figure 87 – 132 VAC 60 Hz, 0-6.5 A Transient Load.
 CH1(Blue): V_{OUT} , 0.5 V / div., 2 ms / div.
 CH2(Pink): I_{OUT} , 2 A / div.
 $V_{OUT(MAX)} = 5.27\text{ V}$, $V_{OMIN} = 4.87\text{ V}$.

11.5 Output Ripple Voltage Waveforms

Tested at room ambient temperature using an E-load at constant current mode setting.

11.5.1 Output Ripple Voltage at $V_{OUT} = 20 \text{ VDC} / 3 \text{ A}$

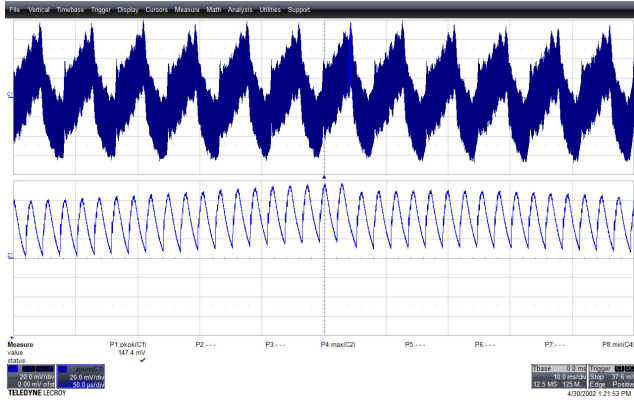

Figure 88 – 100 VAC 60 Hz, Full Load Normal.
Upper: V_{OUT} , 20 mV / div., 10 ms / div.
 $V_{RIPPLE} = 147.4 \text{ mV}$.

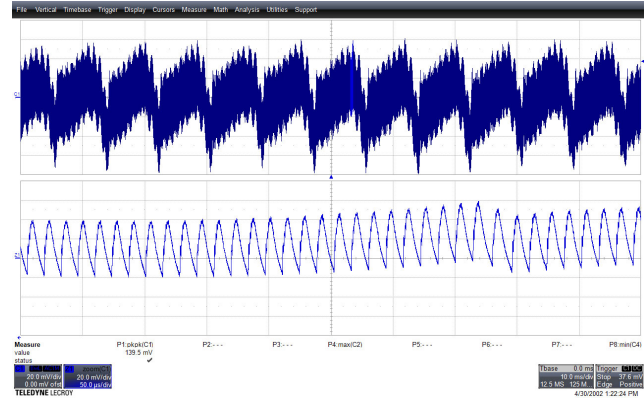

Figure 89 – 132 VAC 60 Hz, Full Load Normal.
Upper: V_{OUT} , 20 mV / div., 10 ms / div.
 $V_{RIPPLE} = 139.5 \text{ mV}$.

11.5.2 Output Ripple Voltage at $V_{OUT} = 15 \text{ VDC} / 3 \text{ A}$

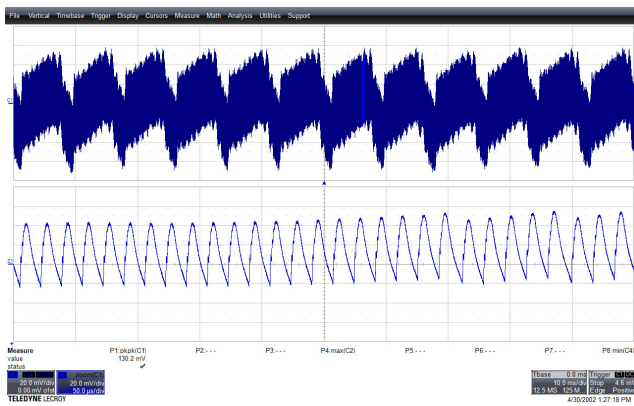

Figure 90 – 100 VAC 60 Hz, Full Load Normal.
Upper: V_{OUT} , 20 mV / div., 10 ms / div.
 $V_{RIPPLE} = 130.2 \text{ mV}$.

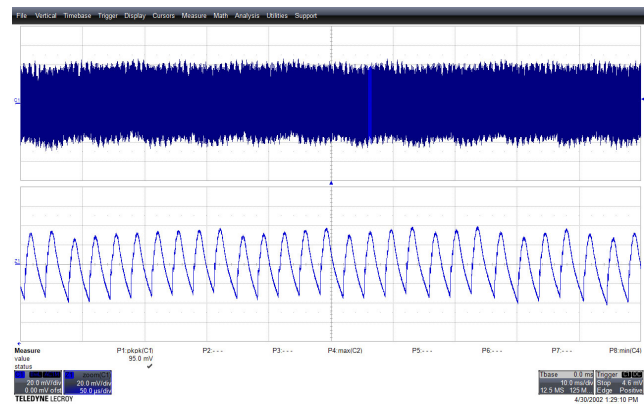

Figure 91 – 132 VAC 60 Hz, Full Load Normal.
Upper: V_{OUT} , 20 mV / div., 10 ms / div.
 $V_{RIPPLE} = 95 \text{ mV}$.

11.5.3 Output Ripple Voltage at $V_{OUT} = 9 \text{ VDC} / 3 \text{ A}$

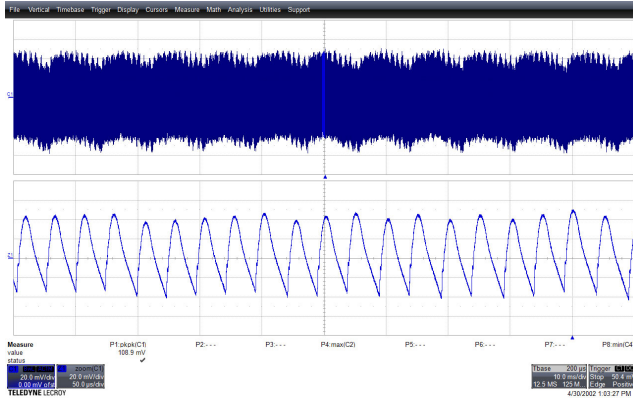

Figure 92 – 100 VAC 60 Hz, Full Load Normal.
Upper: V_{OUT} , 20 mV / div., 10 ms / div.
 $V_{RIPPLE} = 108.9 \text{ mV}$.

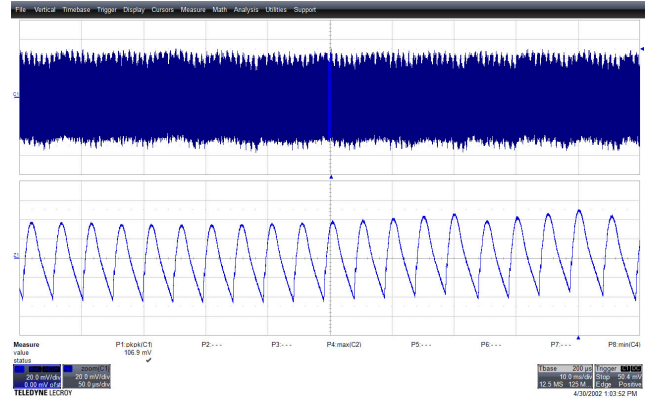

Figure 93 – 132 VAC 60 Hz, Full Load Normal.
Upper: V_{OUT} , 20 mV / div., 10 ms / div.
 $V_{RIPPLE} = 106.9 \text{ mV}$.

11.5.4 Output Ripple Voltage at $V_{OUT} = 5 \text{ VDC} / 3 \text{ A}$

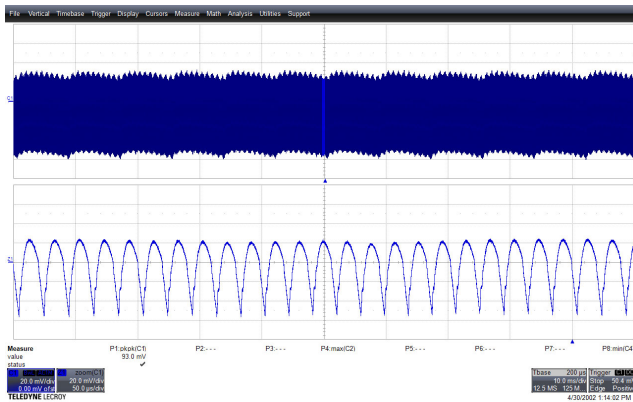

Figure 94 – 100 VAC 60 Hz, Full Load Normal.
Upper: V_{OUT} , 20 mV / div., 10 ms / div.
 $V_{RIPPLE} = 93 \text{ mV}$.

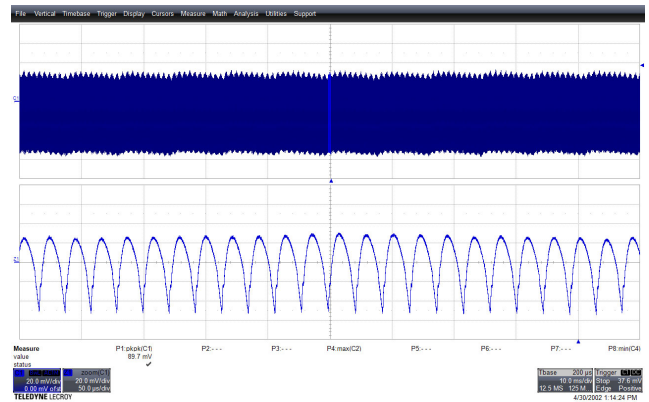

Figure 95 – 132 VAC 60 Hz, Full Load Normal.
Upper: V_{OUT} , 20 mV / div., 10 ms / div.
 $V_{RIPPLE} = 89.7 \text{ mV}$.

11.6 Output Short-Circuit

11.6.1 Output Short-Circuit

Waveforms are captured during the unit was running with an output shorted

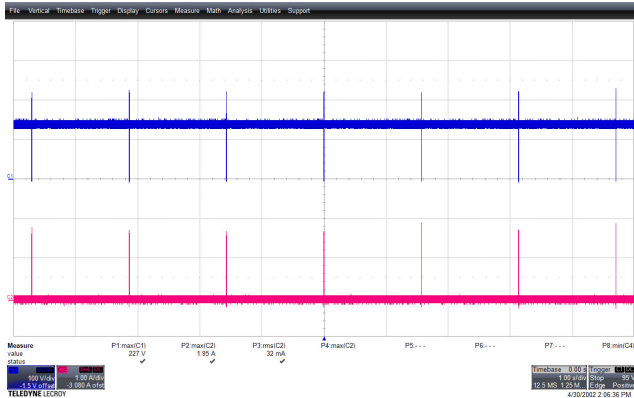

Figure 96 – 100 VAC 60 Hz, Output Short Normal.
CH1(Blue): V_D , 100 V / div., 1 s / div.
CH2(Pink): I_D , 1 A / div.

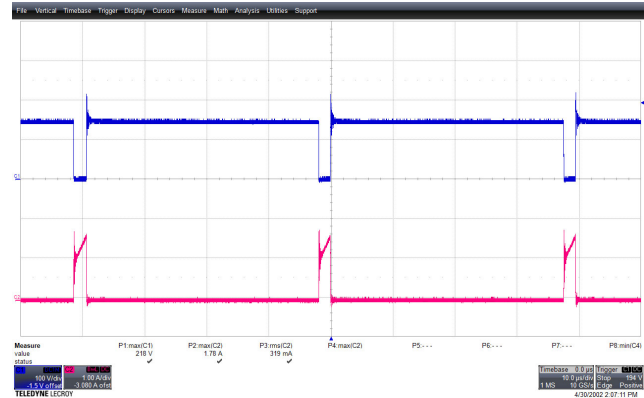

Figure 97 – 100 VAC 60 Hz, Output Short Normal.
Zoom in
CH1(Blue): V_D , 100 V / div., 10 us / div.
CH2(Pink): I_D , 1 A / div.

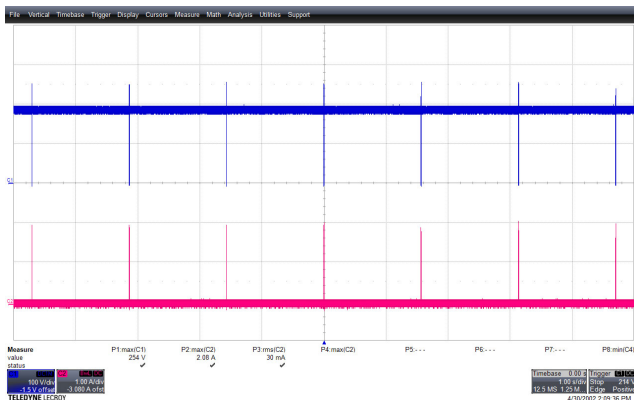

Figure 98 – 132 VAC 60 Hz, Output Short Normal.
CH1(Blue): V_D , 100 V / div., 1 s / div.
CH2(Pink): I_D , 1 A / div.

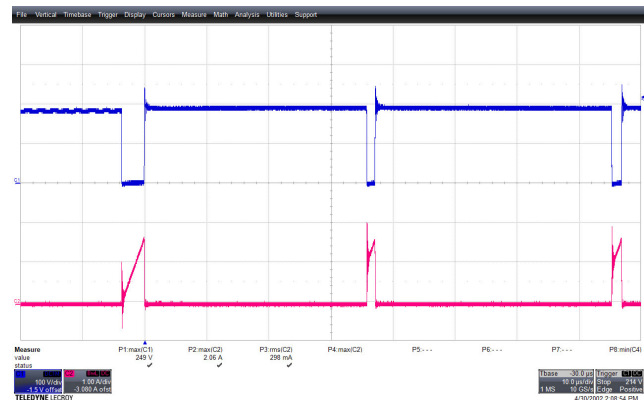

Figure 99 – 132 VAC 60 Hz, Output Short Normal.
Zoom in
CH1(Blue): V_D , 100 V / div., 10 us / div.
CH2(Pink): I_D , 1 A / div.

11.6.2 Start Up with Output Shorted

Note: Unit was powered up with output shorted.

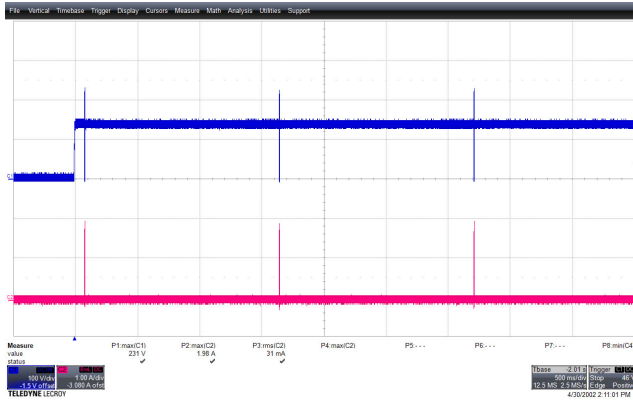

Figure 100 – 100 VAC 60 Hz, Short-Start-up.
 CH1(Blue): V_D , 100 V / div., 1 s / div.
 CH2(Pink): I_D , 1 A / div.

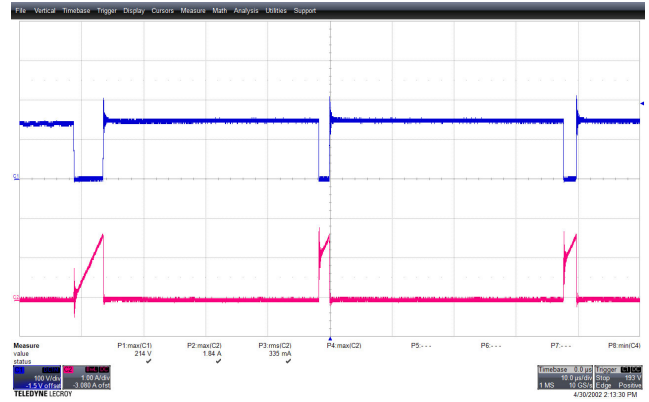

Figure 101 – 100 VAC 60 Hz, Short-Start-up.
 Zoom in
 CH1(Blue): V_D , 100 V / div., 10 μ s / div.
 CH2(Pink): I_D , 1 A / div.

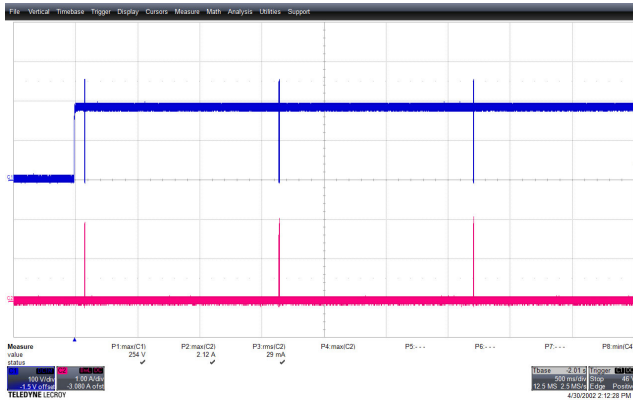

Figure 102 – 132 VAC 60 Hz, Short-Start-up
 CH1(Blue): V_D , 100 V / div., 1 s / div.
 CH2(Pink): I_D , 1 A / div.

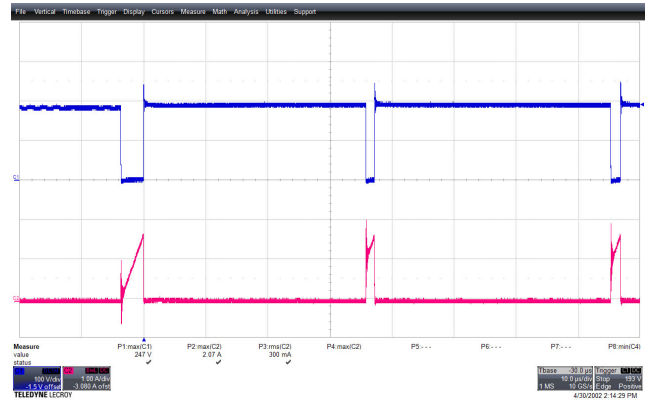

Figure 103 – 132 VAC 60 Hz, Short-Start-up.
 Zoom in
 CH1(Blue): V_D , 100 V / div., 10 μ s / div.
 CH2(Pink): I_D , 1 A / div.

12 Conducted EMI

12.1 *Test Set-up*

EMI measurement was done using a resistor load.

12.2 *Equipment and Load Used*

1. Rohde and Schwarz ENV216 two-line V-network.
2. Rohde and Schwarz ESRP EMI test receiver.
3. Variable Voltage Transformer set at 115 VAC

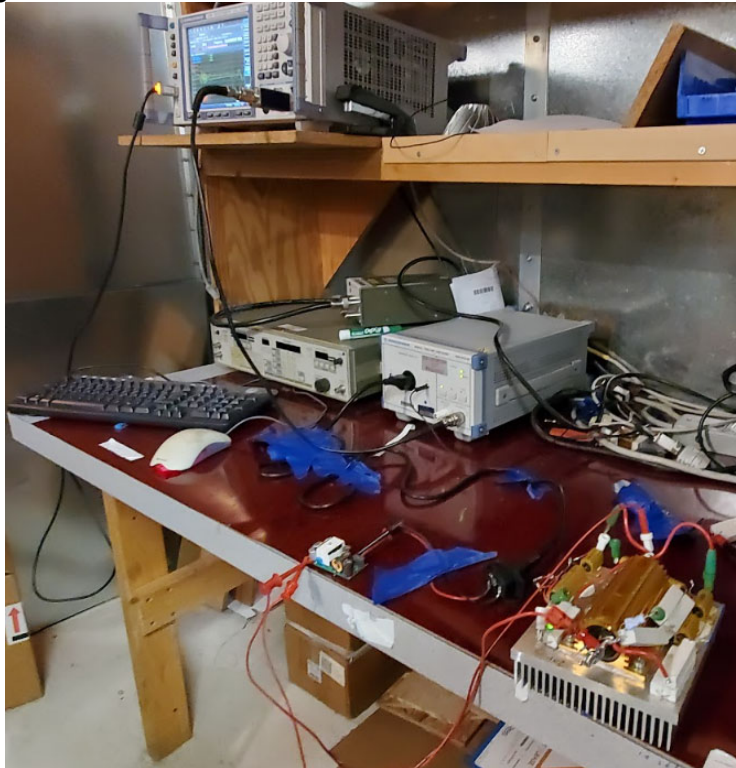

Figure 104 – Conducted EMI Test Set-up.

12.3 Conducted EMI at $V_{OUT} = 20\text{ V}$ Full Load with Output Floating

12.3.1 Output Load: $6.7\ \Omega$ ($20\text{ V} / 3\text{ A}$) fixed resistor

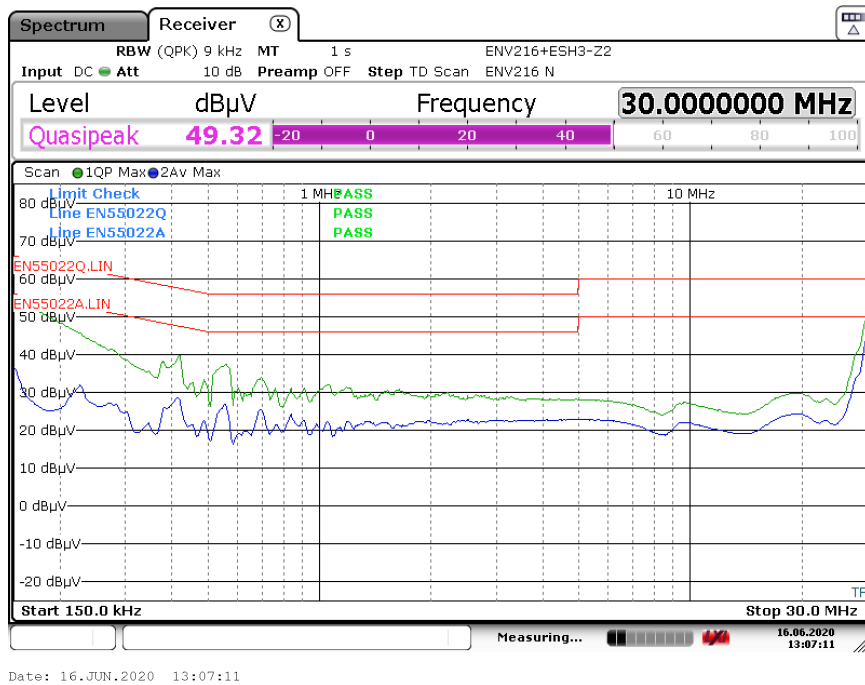

Figure 105 – Conducted EMI at $V_{OUT} = 20\text{ V}$ Full Load, 115 VAC 60 Hz, Floating Output

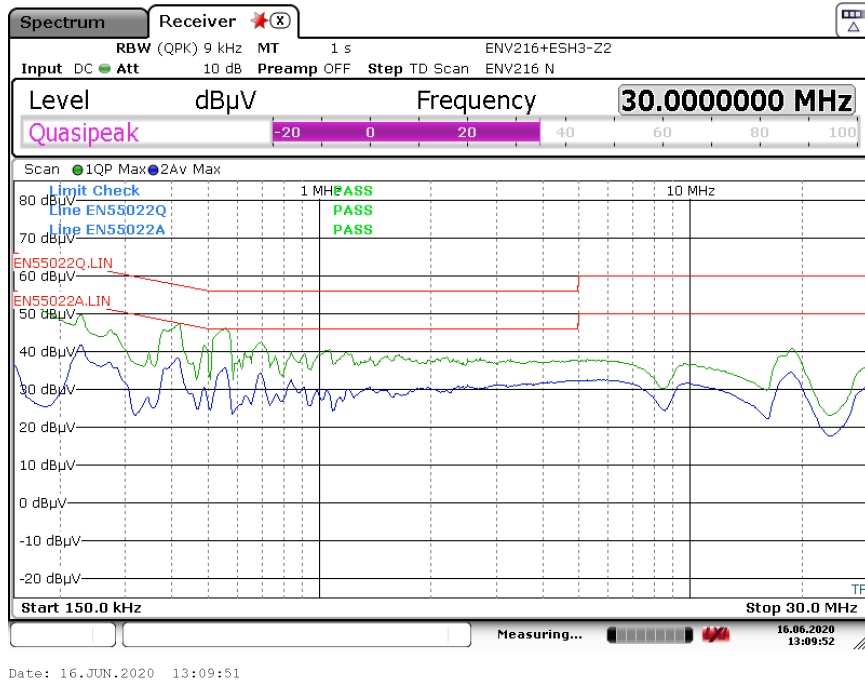

Figure 106 – Conducted EMI at $V_{OUT} = 20\text{ V}$ Full Load, 115 VAC 60 Hz, Output Grounded

12.4 Conducted EMI at $V_{OUT} = 15\text{ V}$ Full Load with Output Floating

12.4.1 Output Load: $5\ \Omega$ ($15\text{ V} / 3\text{ A}$) fixed resistor

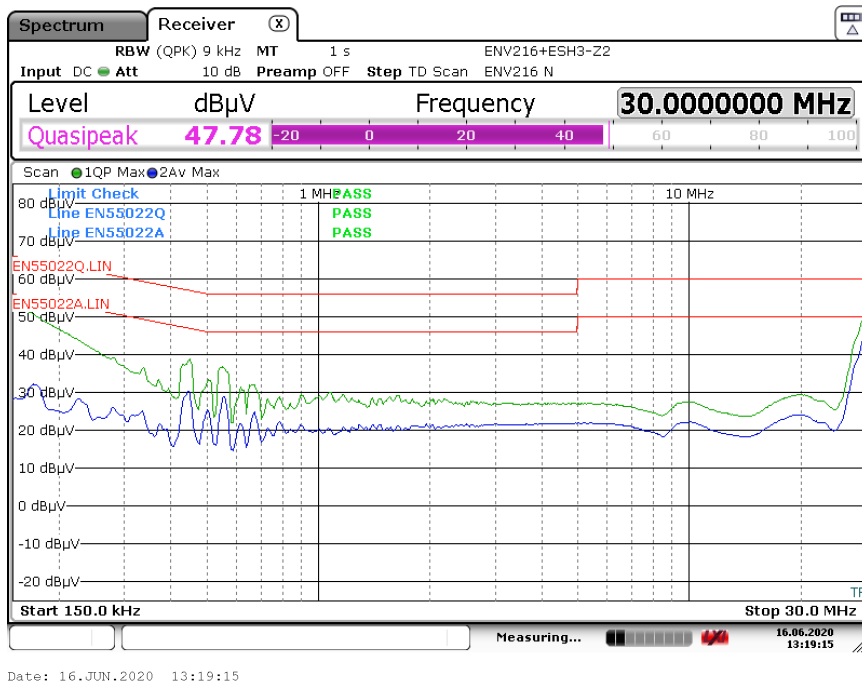

Figure 107 – Conducted EMI at $V_{OUT} = 15\text{ V}$ Full Load, 115 VAC 60 Hz, Floating Output

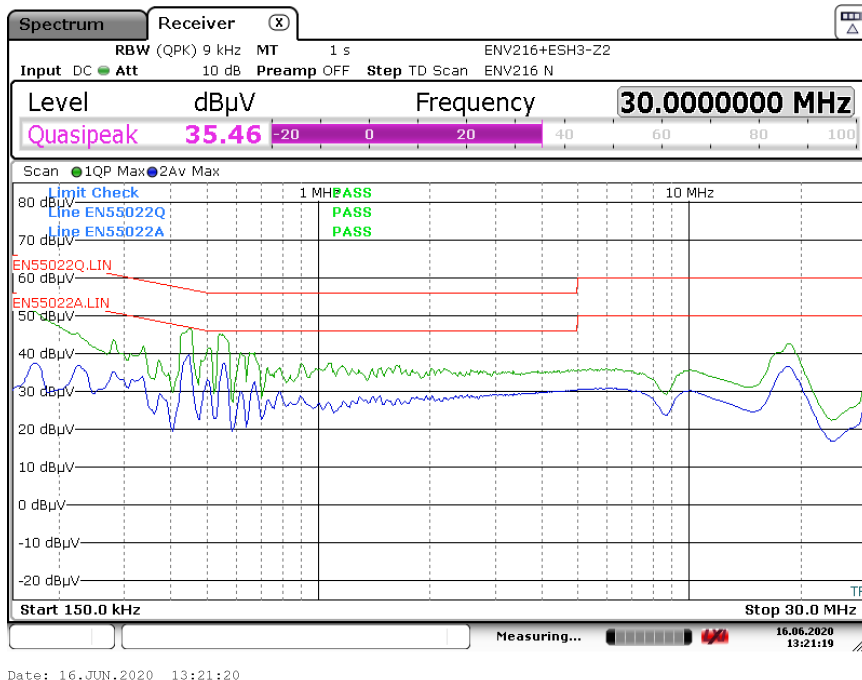

Figure 108 – Conducted EMI at $V_{OUT} = 15\text{ V}$ Full Load, 115 VAC 60 Hz, Output Grounded

12.5 **Conducted EMI at $V_{OUT} = 9\text{ V}$ Full Load with Output Floating**

12.5.1 Output Load: $1.8\ \Omega$ ($9\text{ V} / 5\text{ A}$) fixed resistor

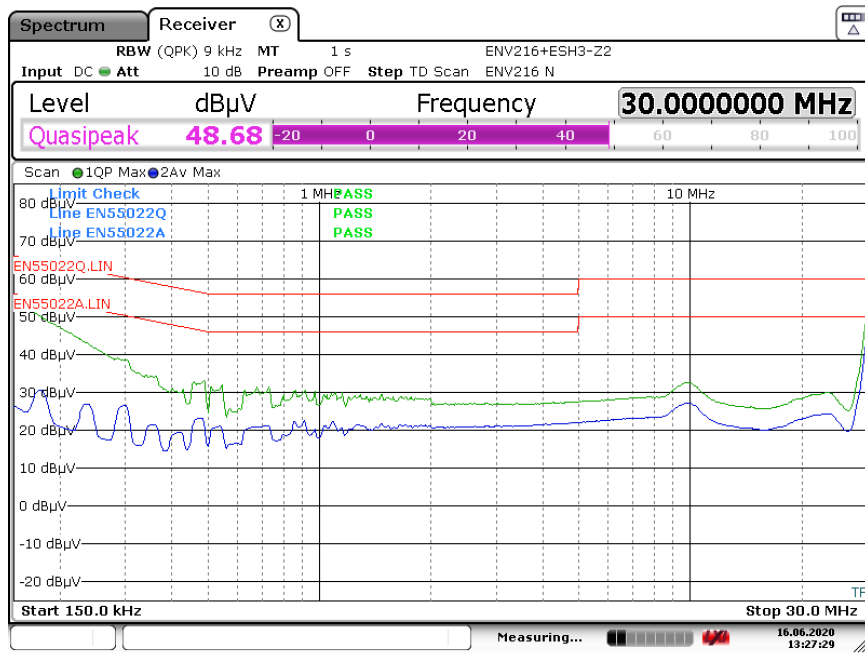

Figure 109 – Conducted EMI at $V_{OUT} = 9\text{ V}$ Full Load, 115 VAC 60 Hz, Floating Output

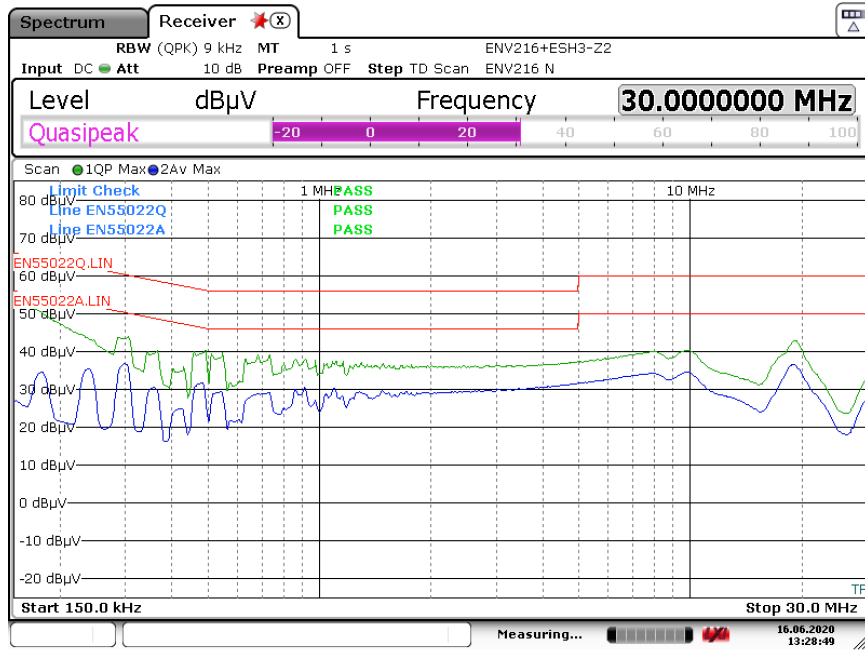

Figure 110 – Conducted EMI at $V_{OUT} = 9\text{ V}$ Full Load, 115 VAC 60 Hz, Output Grounded

12.6 Conducted EMI at $V_{OUT} = 5\text{ V}$ Full Load with Output Floating

12.6.1 Output Load: $0.78\ \Omega$ ($5\text{ V} / 6.5\text{ A}$) fixed resistor

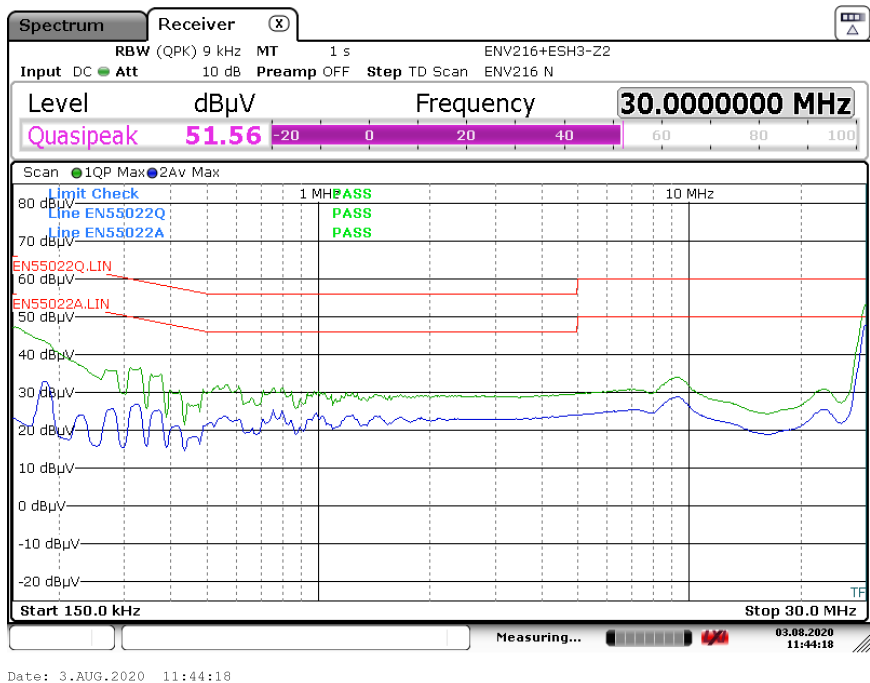

Figure 111 – Conducted EMI at $V_{OUT} = 5\text{ V}$ Full Load, 115 VAC 60 Hz, Floating Output

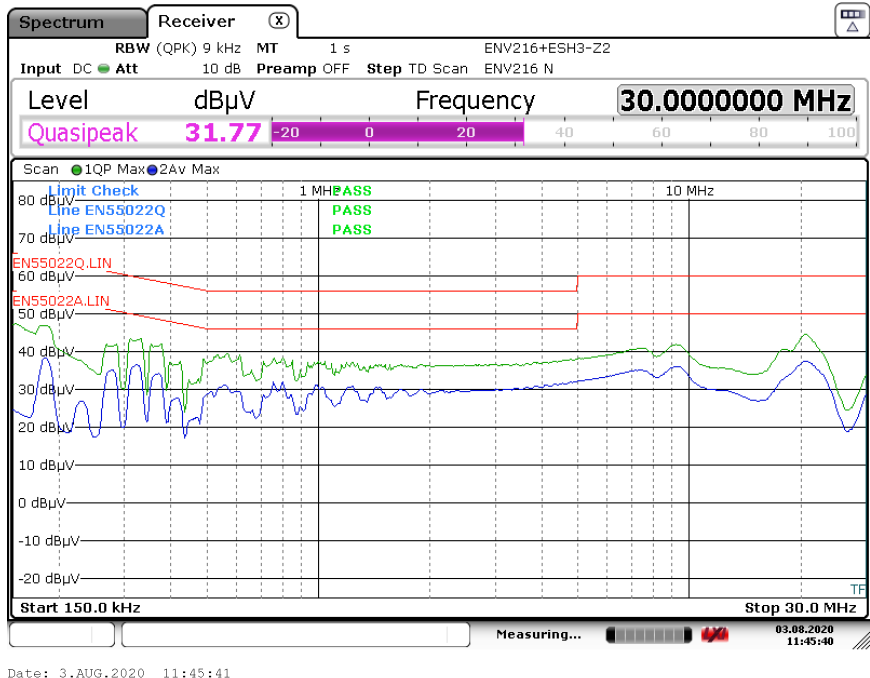

Figure 112 – Conducted EMI at $V_{OUT} = 5\text{ V}$ Full Load, 115 VAC 60 Hz, Output Grounded

13 Line Immunity

Output Load set at max load (20 V / 3 A) using a 6.67 Ω Fixed Resistor

13.1 Differential Surge Test Results

Source Impedance: 2Ω

Repetition Rate: 1/30 s

No. of surge strike per location: 10 strikes

Differential Surge	Input Voltage (VAC)	Injection Location	Injection Phase (°)	Test Result (Pass/Fail)
2000	120	L to N	0	Pass
-2000	120	L to N	0	Pass
2000	120	L to N	90	Pass
-2000	120	L to N	90	Pass
2000	120	L to N	270	Pass
-2000	120	L to N	270	Pass

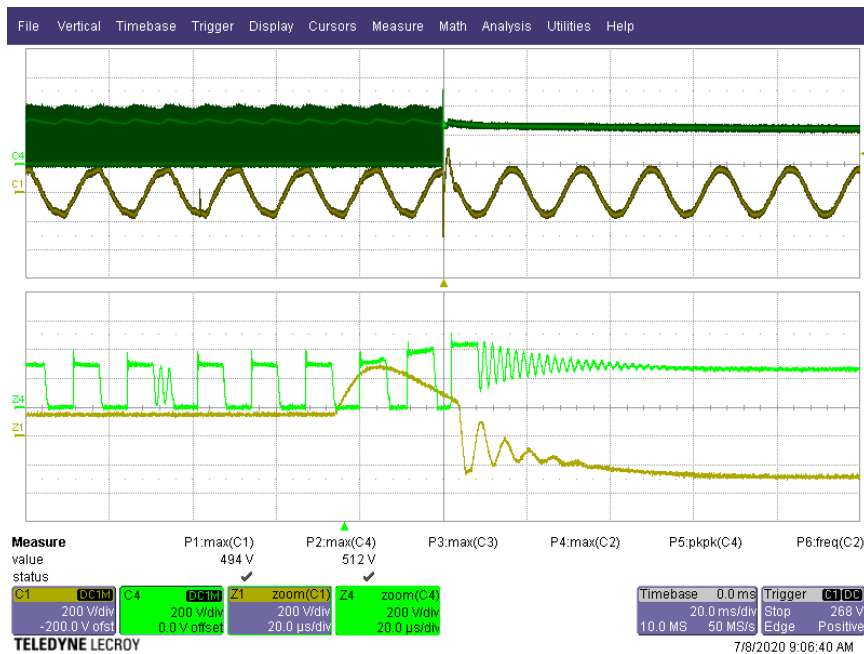

Figure 113 – 120 VAC 60 Hz, 2 kV Differential Surge L-N.

Injection Phase: 90°.

Upper: V_{DRAIN}, 200 V / div.

Lower: V_{IN}, 200 V / div., 20 ms / div.

V_{DS} = 494 V.

13.2 Ring Wave Surge Test Results

Source Impedance: 12Ω

Repetition Rate: 1/30 s

No. of surge strike per location: 10 strikes

Differential Surge	Input Voltage (VAC)	Injection Location	Injection Phase (°)	Test Result (Pass/Fail)
2500	230	L to N	0	Pass
-2500	230	L to N	0	Pass
2500	230	L to N	90	Pass
-2500	230	L to N	90	Pass
2500	230	L to N	270	Pass
-2500	230	L to N	270	Pass

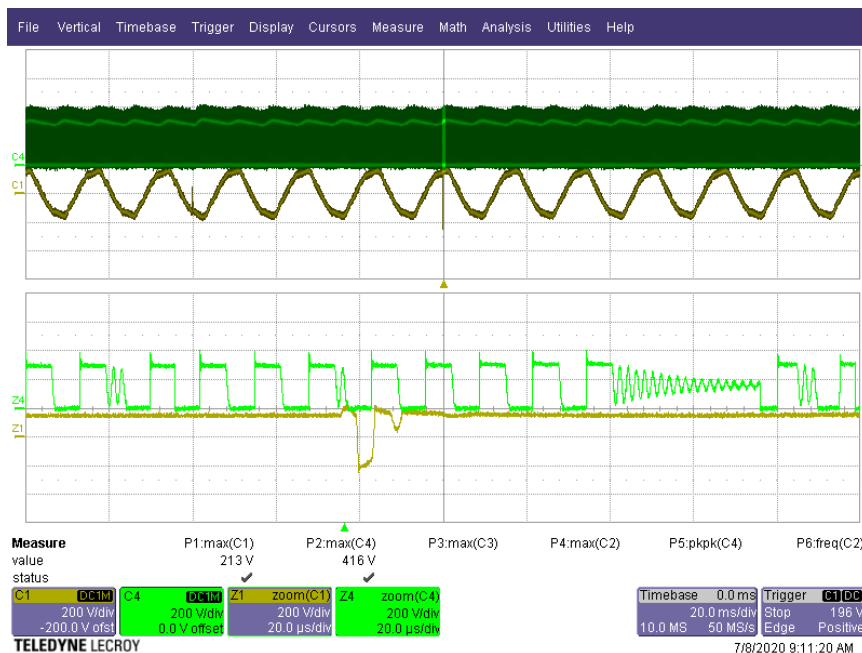

Figure 114 – 120 VAC 60 Hz, 2.5kV Ring Wave L-N.
 Injection Phase: 90°.
 Upper: V_{DRAIN}, 200 V / div.
 Lower: V_{IN}, 200 V / div., 20 ms / div.
 V_{DS} = 416 V.

14 ESD

Unit was subjected to ± 8 kV, ± 12 kV and ± 15 kV ESD air discharge test. An LED indicator connected across the resistor load was used to observe the output behavior during to ESD. A test failure was defined as a non-recoverable interruption of output requiring repair or recycling of input voltage.

Note: Output Load set at max load (20 V / 3 A) using a 6.67 Ω Fixed Resistor

14.1 ESD Discharge at the End of the Output Cable

No.	Test Voltage	No. of Strikes	Discharge Location	Remarks	Pass / Fail
1	+8	10	+ Output Terminal End of cable	No Damage / No AR	Pass
2		10	- Output Terminal End of cable	No Damage / No AR	Pass
1	-8	10	+ Output Terminal End of cable	No Damage / No AR	Pass
2		10	- Output Terminal End of cable	No Damage / No AR	Pass
1	+12	10	+ Output Terminal End of cable	No Damage / No AR	Pass
2		10	- Output Terminal End of cable	No Damage / No AR	Pass
1	-12	10	+ Output Terminal End of cable	No Damage / No AR	Pass
2		10	- Output Terminal End of cable	No Damage / No AR	Pass
1	+15	10	+ Output Terminal End of cable	No Damage / No AR	Pass
2		10	- Output Terminal End of cable	No Damage / No AR	Pass
1	-15	10	+ Output Terminal End of cable	No Damage / No AR	Pass
2		10	- Output Terminal End of cable	No Damage / No AR	Pass

15 Brown-Out / Brown-Out Recovery Test

No abnormal overheating or voltage overshoot/undershoot was observed during and after 0.5 V / s. The unit works normally after the brown-out test.

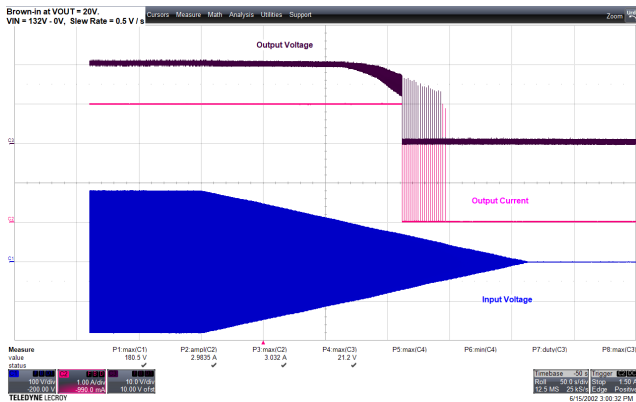

Figure 115 – Brown-Out at $V_{OUT} = 20\text{ V}$.
 $V_{IN} = 132\text{ V} - 0\text{ V}$, Slew Rate = $0.5\text{ V} / \text{s}$.
 CH1(Blue): V_{IN} , $100\text{ V} / \text{div.}$, $50\text{ s} / \text{div.}$
 CH2(Pink): I_{OUT} , $5\text{ A} / \text{div.}$
 CH3(Purple): V_{OUT} , $2\text{ V} / \text{div.}$

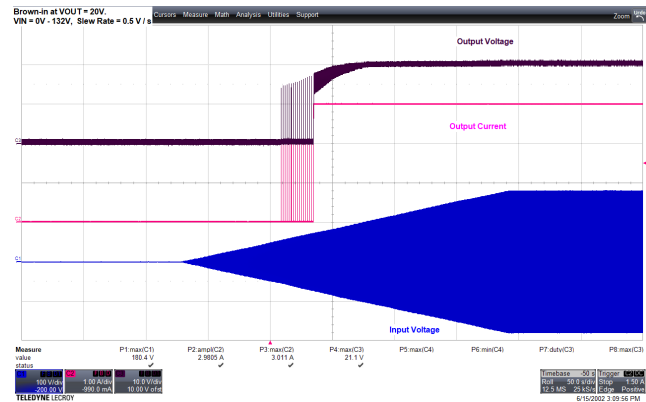

Figure 116 – Brown-in at $V_{OUT} = 20\text{ V}$.
 $V_{IN} = 0\text{ V} - 132\text{ V}$, Slew Rate = $0.5\text{ V} / \text{s}$.
 CH1(Blue): V_{IN} , $100\text{ V} / \text{div.}$, $50\text{ s} / \text{div.}$
 CH2(Pink): I_{OUT} , $5\text{ A} / \text{div.}$
 CH3(Purple): V_{OUT} , $2\text{ V} / \text{div.}$

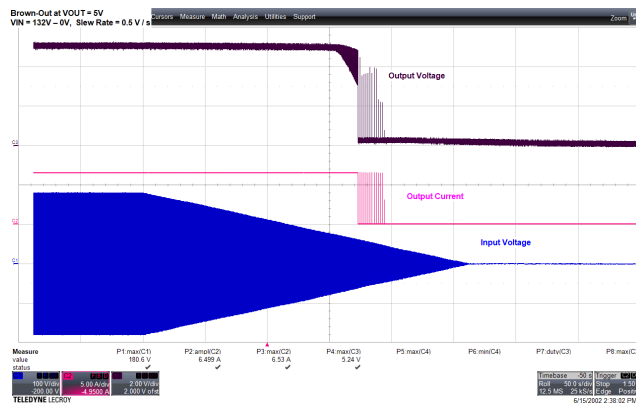

Figure 117 – Brown-Out at $V_{OUT} = 5\text{ V}$.
 $V_{IN} = 132\text{ V} - 0\text{ V}$, Slew Rate = $0.5\text{ V} / \text{s}$.
 CH1(Blue): V_{IN} , $100\text{ V} / \text{div.}$, $50\text{ s} / \text{div.}$
 CH2(Pink): I_{OUT} , $5\text{ A} / \text{div.}$
 CH3(Purple): V_{OUT} , $2\text{ V} / \text{div.}$

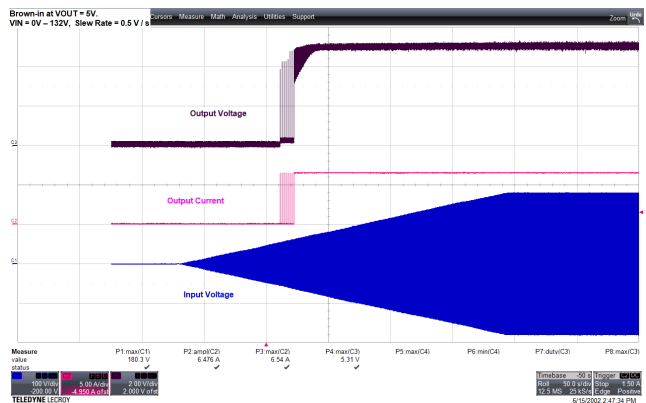

Figure 118 – Brown-in at $V_{OUT} = 5\text{ V}$.
 $V_{IN} = 0\text{ V} - 132\text{ V}$, Slew Rate = $0.5\text{ V} / \text{s}$.
 CH1(Blue): V_{IN} , $100\text{ V} / \text{div.}$, $50\text{ s} / \text{div.}$
 CH2(Pink): I_{OUT} , $5\text{ A} / \text{div.}$
 CH3(Purple): V_{OUT} , $2\text{ V} / \text{div.}$

16 Revision History

Date	Author	Revision	Description and Changes	Reviewed
16-Sep-20	MGM	1.0	Initial release	Apps & Mktg
20-Jul-22	KM	MGM	Added Supplier for T1	Apps & Mktg



For the latest updates, visit our website: www.power.com

Reference Designs are technical proposals concerning how to use Power Integrations' gate drivers in particular applications and/or with certain power modules. These proposals are "as is" and are not subject to any qualification process. The suitability, implementation and qualification are the sole responsibility of the end user. The statements, technical information and recommendations contained herein are believed to be accurate as of the date hereof. All parameters, numbers, values and other technical data included in the technical information were calculated and determined to our best knowledge in accordance with the relevant technical norms (if any). They may be based on assumptions or operational conditions that do not necessarily apply in general. We exclude any representation or warranty, express or implied, in relation to the accuracy or completeness of the statements, technical information and recommendations contained herein. No responsibility is accepted for the accuracy or sufficiency of any of the statements, technical information, recommendations or opinions communicated and any liability for any direct, indirect or consequential loss or damage suffered by any person arising therefrom is expressly disclaimed.

Power Integrations reserves the right to make changes to its products at any time to improve reliability or manufacturability. Power Integrations does not assume any liability arising from the use of any device or circuit described herein. POWER INTEGRATIONS MAKES NO WARRANTY HEREIN AND SPECIFICALLY DISCLAIMS ALL WARRANTIES INCLUDING, WITHOUT LIMITATION, THE IMPLIED WARRANTIES OF MERCHANTABILITY, FITNESS FOR A PARTICULAR PURPOSE, AND NON-INFRINGEMENT OF THIRD PARTY RIGHTS.

Patent Information

The products and applications illustrated herein (including transformer construction and circuits' external to the products) may be covered by one or more U.S. and foreign patents, or potentially by pending U.S. and foreign patent applications assigned to Power Integrations. A complete list of Power Integrations' patents may be found at www.power.com. Power Integrations grants its customers a license under certain patent rights as set forth at <http://www.power.com/ip.htm>.

Power Integrations, the Power Integrations logo, CAPZero, ChiPhy, CHY, DPA-Switch, EcoSmart, E-Shield, eSIP, eSOP, HiperPLC, HiperPFS, HiperTFS, InnoSwitch, Innovation in Power Conversion, InSOP, LinkSwitch, LinkZero, LYTSwitch, SENZero, TinySwitch, TOPSwitch, PI, PI Expert, SCALE, SCALE-1, SCALE-2, SCALE-3 and SCALE-iDriver, are trademarks of Power Integrations, Inc. Other trademarks are property of their respective companies. ©2019, Power Integrations, Inc.

Power Integrations Worldwide Sales Support Locations**WORLD HEADQUARTERS**

5245 Hellyer Avenue
San Jose, CA 95138, USA.
Main: +1-408-414-9200
Customer Service:
Worldwide: +1-65-635-64480
Americas: +1-408-414-9621
e-mail: usasales@power.com

CHINA (SHANGHAI)

Rm 2410, Charity Plaza, No. 88,
North Caoxi Road,
Shanghai, PRC 200030
Phone: +86-21-6354-6323
e-mail: chinasales@power.com

CHINA (SHENZHEN)

17/F, Hivac Building, No. 2, Keji
Nan 8th Road, Nanshan District,
Shenzhen, China, 518057
Phone: +86-755-8672-8689
e-mail: chinasales@power.com

GERMANY (AC-DC/LED Sales)

Einsteinring 24
85609 Dornach/Aschheim
Germany
Tel: +49-89-5527-39100
e-mail: eurosales@power.com

GERMANY (Gate Driver Sales)

HellwegForum 1
59469 Ense
Germany
Tel: +49-2938-64-39990
e-mail: igbt-driver.sales@power.com

INDIA

#1, 14th Main Road
Vasanthanagar
Bangalore-560052
India
Phone: +91-80-4113-8020
e-mail: indiasales@power.com

ITALY

Via Milanese 20, 3rd Fl.
20099 Sesto San Giovanni (MI) Italy
Phone: +39-024-550-8701
e-mail: eurosales@power.com

JAPAN

Yusen Shin-Yokohama 1-chome Bldg.
1-7-9, Shin-Yokohama, Kohoku-ku
Yokohama-shi,
Kanagawa 222-0033 Japan
Phone: +81-45-471-1021
e-mail: japansales@power.com

KOREA

RM 602, 6FL
Korea City Air Terminal B/D,
159-6
Samsung-Dong, Kangnam-Gu,
Seoul, 135-728 Korea
Phone: +82-2-2016-6610
e-mail: koreasales@power.com

SINGAPORE

51 Newton Road,
#19-01/05 Goldhill Plaza
Singapore, 308900
Phone: +65-6358-2160
e-mail:
singaporesales@power.com

TAIWAN

5F, No. 318, Nei Hu Rd.,
Sec. 1
Nei Hu District
Taipei 11493, Taiwan R.O.C.
Phone: +886-2-2659-4570
e-mail: taiwansales@power.com

UK

Building 5, Suite 21
The Westbrook Centre
Milton Road
Cambridge
CB4 1YG
Phone: +44 (0) 7823-557484
e-mail: eurosales@power.com

