



January 2014

[Fairchild Power Supply WebDesigner — Flyback Design & Simulation - In Minutes at No Expense](#)

# FSEZ1307 Primary-Side-Regulation PWM with Power MOSFET Integrated

## Features

- Low Standby Power: Under 30 mW
- High-Voltage Startup
- Few External Components
- Constant-Voltage (CV) and Constant-Current (CC) Control without Secondary-Feedback Circuitry
- Green Mode: Linearly Decreasing PWM Frequency
- Fixed PWM Frequency at 50 kHz with Frequency Hopping to Solve EMI Problem
- Cable Compensation in CV Mode
- Peak-Current-Mode Control in CV Mode
- Cycle-by-Cycle Current Limiting
- $V_{DD}$  Over-Voltage Protection with Auto Restart
- $V_{DD}$  Under-Voltage Lockout (UVLO)
- Gate Output Maximum Voltage Clamped at 15 V
- Fixed Over-Temperature Protection with Auto Restart
- Available in 7-Lead SOP Package

## Applications

- Battery chargers for cellular phones, cordless phones, PDA, digital cameras, power tools, etc.
- Replaces linear transformers and RCC SMPS

## Description

This third-generation Primary Side Regulation (PSR) PWM controller combination power MOSFET, FSEZ1307, provides several features to enhance the performance of low-power flyback converters. The proprietary topology, TRUECURRENT®, enables precise CC regulation and simplified circuit design for battery-charger applications. Compared to a conventional design or a linear transformer, a low-cost, smaller, and lighter charger results.

To minimize standby power consumption, the proprietary green mode provides off-time modulation to linearly decrease PWM frequency under light-load conditions. Green mode assists the power supply in meeting power conservation requirements.

By using the FSEZ1307, a charger can be implemented with few external components and minimized cost. A typical output CV/CC characteristic envelope is shown in Figure 1.

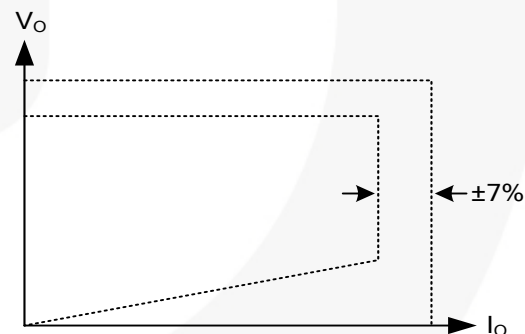

Figure 1. Typical Output V-I Characteristic

## Ordering Information

Part Number	Operating Temperature Range	Package	Packing Method
FSEZ1307MY	-40°C to +105°C	7-Lead, Small Outline Package (SOP-7)	Tape & Reel

For Fairchild's definition of Eco Status, please visit: [http://www.fairchildsemi.com/company/green/rohs\\_green.html](http://www.fairchildsemi.com/company/green/rohs_green.html).

### Application Diagram

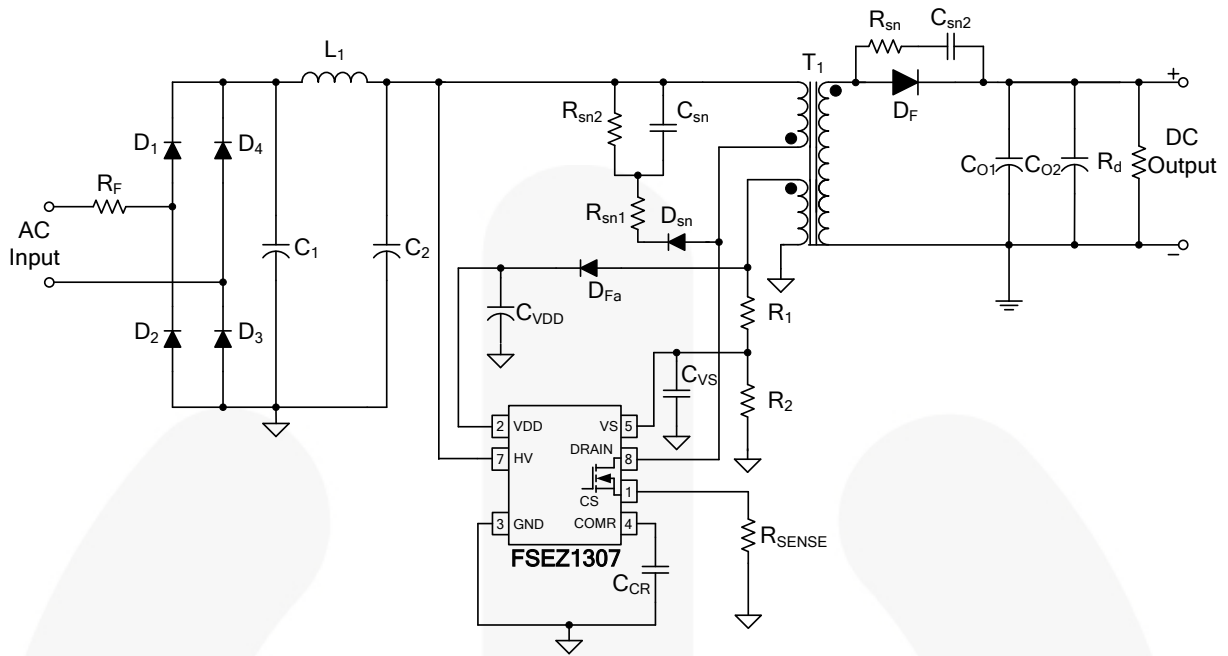

Figure 2. Typical Application

### Internal Block Diagram

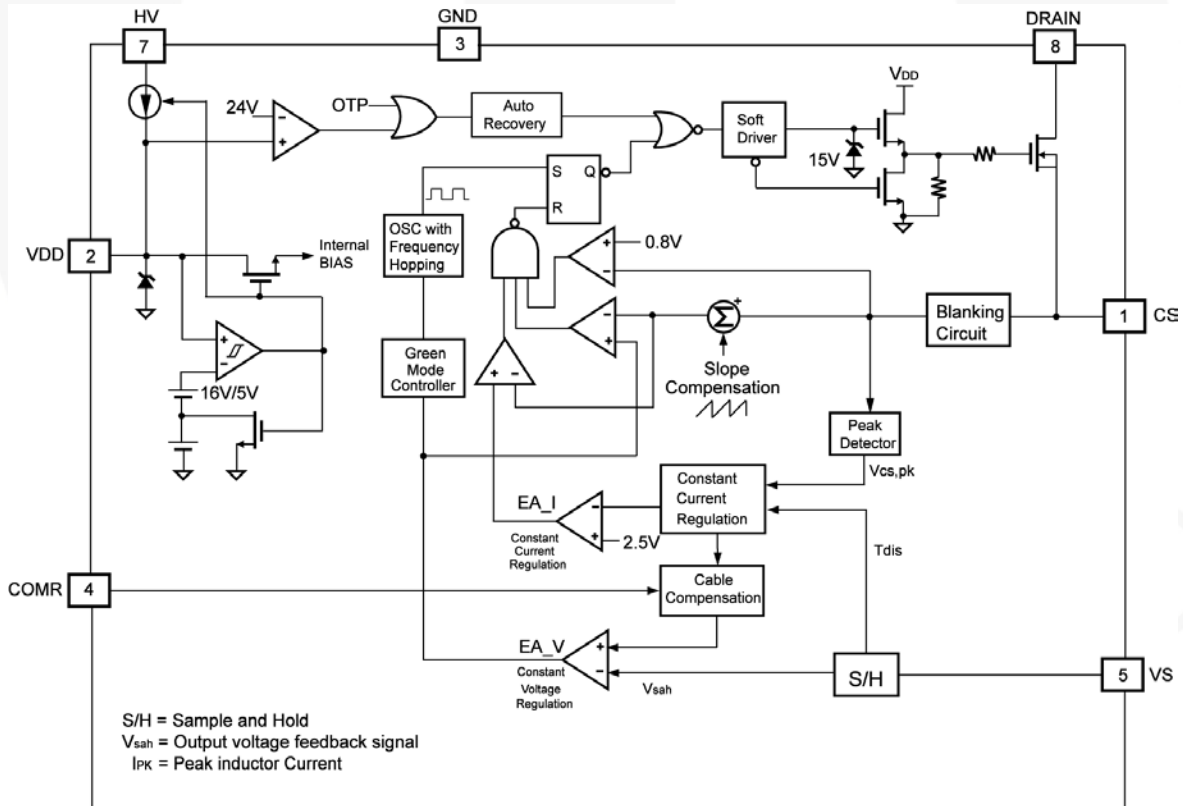
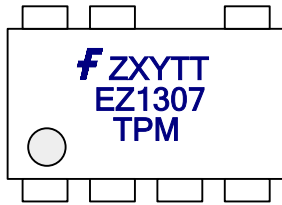

Figure 3. Functional Block Diagram

## Marking Information



F: Fairchild Logo  
 Z: Plant Code  
 X: 1-Digit Year Code  
 Y: 1-Digit Week Code  
 TT: 2-Digit Die Run Code  
 T: Package Type (M=SOP)  
 P: Y=Green Package  
 M: Manufacture Flow Code

Figure 4. Top Mark

## Pin Configuration

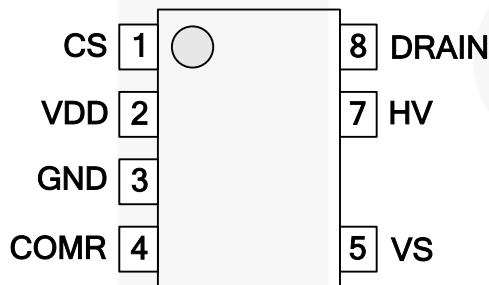

Figure 5. Pin Configuration

## Pin Definitions

Pin #	Name	Description
1	CS	<b>Current Sense.</b> This pin connects a current-sense resistor to detect the MOSFET current for peak-current-mode control in CV mode and provides the output-current regulation in CC mode.
2	VDD	<b>Power Supply.</b> IC operating current and MOSFET driving current are supplied using this pin. This pin is connected to an external $V_{DD}$ capacitor of typically 10 $\mu\text{F}$ . The threshold voltages for startup and turn-off are 16 V and 5 V, respectively. The operating current is lower than 5 mA.
3	GND	<b>Ground</b>
4	COMR	<b>Cable Compensation.</b> This pin connects a 1 $\mu\text{F}$ capacitor between the COMR and GND pins for compensation voltage drop due to output cable loss in CV mode.
5	VS	<b>Voltage Sense.</b> This pin detects the output voltage information and discharge time based on voltage of auxiliary winding.
7	HV	<b>High Voltage.</b> This pin connects to a bulk capacitor for high-voltage startup.
8	DRAIN	<b>Driver Output.</b> Power MOSFET drain. This pin is the high-voltage power MOSFET drain.

## Absolute Maximum Ratings

Stresses exceeding the absolute maximum ratings may damage the device. The device may not function or be operable above the recommended operating conditions and stressing the parts to these levels is not recommended. In addition, extended exposure to stresses above the recommended operating conditions may affect device reliability. The absolute maximum ratings are stress ratings only.

Symbol	Parameter		Min.	Max.	Units
V <sub>HV</sub>	HV Pin Input Voltage			500	V
V <sub>VDD</sub>	DC Supply Voltage <sup>(1,2)</sup>			30	V
V <sub>VS</sub>	VS Pin Input Voltage		-0.3	7.0	V
V <sub>CS</sub>	CS Pin Input Voltage		-0.3	7.0	V
V <sub>COMV</sub>	Voltage Error Amplifier Output Voltage		-0.3	7.0	V
V <sub>COMI</sub>	Current Error Amplifier Output Voltage		-0.3	7.0	V
V <sub>DS</sub>	Drain-Source Voltage			700	V
I <sub>D</sub>	Continuous Drain Current	T <sub>A</sub> =25°C		0.5	A
		T <sub>A</sub> =100°C		0.35	A
I <sub>DM</sub>	Pulsed Drain Current			3.5	A
E <sub>AS</sub>	Single Pulse Avalanche Energy			35	mJ
I <sub>AR</sub>	Avalanche Current			1	A
P <sub>D</sub>	Power Dissipation (T <sub>A</sub> < 50°C)			660	mW
θ <sub>JA</sub>	Thermal Resistance (Junction to Air)			150	°C/W
θ <sub>JC</sub>	Thermal Resistance (Junction to Case)			39	°C/W
T <sub>J</sub>	Operating Junction Temperature		-40	+150	°C
T <sub>STG</sub>	Storage Temperature Range		-55	+150	°C
T <sub>L</sub>	Lead Temperature (Wave Soldering or IR, 10 Seconds)			+260	°C
ESD	Electrostatic Discharge Capability	Human Body Model (Except HV Pin), JEDEC-JESD22_A114		2500	V
		Charged Device Model (Except HV Pin), JEDEC-JESD22_C101		1250	

### Notes:

1. Stresses beyond those listed under Absolute Maximum Ratings may cause permanent damage to the device.
2. All voltage values, except differential voltages, are given with respect to the GND pin.

## Recommended Operating Conditions

The Recommended Operating Conditions table defines the conditions for actual device operation. Recommended operating conditions are specified to ensure optimal performance to the datasheet specifications. Fairchild does not recommend exceeding them or designing to Absolute Maximum Ratings.

Symbol	Parameter	Min.	Max.	Units
T <sub>A</sub>	Operating Ambient Temperature	-40	+105	°C

## Electrical Characteristics

Unless otherwise specified,  $V_{DD}=15\text{ V}$  and  $T_A=25^\circ\text{C}$ .

Symbol	Parameter	Conditions	Min.	Typ.	Max.	Units	
<b>V<sub>DD</sub> Section</b>							
$V_{OP}$	Continuously Operating Voltage				23	V	
$V_{DD-ON}$	Turn-On Threshold Voltage		15	16	17	V	
$V_{DD-OFF}$	Turn-Off Threshold Voltage		4.5	5.0	5.5	V	
$I_{DD-OP}$	Operating Current			2.5	5.0	mA	
$I_{DD-GREEN}$	Green-Mode Operating Supply Current			0.95	1.20	mA	
$V_{DD-OVP}$	$V_{DD}$ Over-Voltage-Protection Level (OVP)			24		V	
$V_{DD-OVP-HYS}$	Hysteresis Voltage for $V_{DD}$ OVP		1.5	2.0	2.5	V	
$t_{D-VDDOVP}$	$V_{DD}$ Over-Voltage-Protection Debounce Time		50	200	300	$\mu\text{s}$	
<b>HV Startup Current Source Section</b>							
$V_{HV-MIN}$	Minimum Startup Voltage on HV Pin				50	V	
$I_{HV}$	Supply Current Drawn from HV Pin	$V_{DC}=100\text{ V}$		1.5	3.0	mA	
$I_{HV-LC}$	Leakage Current after Startup	HV=500 V, $V_{DD}=V_{DD-OFF}+1\text{ V}$		0.96	3.00	$\mu\text{A}$	
<b>Oscillator Section</b>							
$f_{OSC}$	Frequency	Center Frequency		47	50	53	kHz
		Frequency Hopping Range		$\pm 1.5$	$\pm 2.0$	$\pm 2.5$	
$f_{OSC-N-MIN}$	Minimum Frequency at No-Load			370		Hz	
$f_{OSC-CM-MIN}$	Minimum Frequency at CCM			13		kHz	
$f_{DV}$	Frequency Variation vs. $V_{DD}$ Deviation	$V_{DD}=10\sim 25\text{ V}$ ,		1	2	%	
$f_{DT}$	Frequency Variation vs. Temperature Deviation	$T_A=-40^\circ\text{C}$ to $105^\circ\text{C}$			15	%	
<b>Voltage-Sense Section</b>							
$I_{IC}$	IC Bias Current			10		$\mu\text{A}$	
$V_{BIAS-COMV}$	Adaptive Bias Voltage Dominated by $V_{COMV}$	$R_{VS}=20\text{ k}\Omega$		1.4		V	
<b>Current-Sense Section</b>							
$t_{PD}$	Propagation Delay to GATE Output			90	200	ns	
$t_{MIN-N}$	Minimum On Time at No-Load		700	850	1050	ns	
$V_{TH}$	Threshold Voltage for Current Limit			0.8		V	
<b>Voltage-Error-Amplifier Section</b>							
$V_{VR}$	Reference Voltage		2.475	2.500	2.525	V	
$V_N$	Green-Mode Starting Voltage on EA_V	$f_{OSC}=2\text{ kHz}$		2.5		V	
$V_G$	Green-Mode Ending Voltage on EA_V	$f_{OSC}=1\text{ kHz}$		0.4		V	
<b>Current-Error-Amplifier Section</b>							
$V_{IR}$	Reference Voltage		2.475	2.500	2.525	V	
<b>Cable Compensation Section</b>							
$V_{COMR}$	COMR Pin for Cable Compensation			0.75		V	

Continued on the following page...

### Electrical Characteristics (Continued)

Unless otherwise specified,  $V_{DD}=15\text{ V}$  and  $T_A=25^\circ\text{C}$ .

Symbol	Parameter	Conditions	Min.	Typ.	Max.	Units
<b>Internal MOSFET Section<sup>(3)</sup></b>						
$DCY_{MAX}$	Maximum Duty Cycle		70	75	80	%
$BV_{DSS}$	Drain-Source Breakdown Voltage	$I_D=250\ \mu\text{A}$ , $V_{GS}=0\ \text{V}$	700			V
$\Delta BV_{DSS}/\Delta T_J$	Breakdown Voltage Temperature Coefficient	$I_D=250\ \mu\text{A}$ , Referenced to $T_A=25^\circ\text{C}$		0.53		$\text{V}/^\circ\text{C}$
$R_{DS(ON)}$	Static Drain-Source On-Resistance	$I_D=0.5\ \text{A}$ , $V_{GS}=10\ \text{V}$		17	20	$\Omega$
$I_S$	Maximum Continuous Drain-Source Diode Forward Current				0.5	A
$I_{DSS}$	Drain-Source Leakage Current	$V_{DS}=700\ \text{V}$ , $T_A=25^\circ\text{C}$			10	$\mu\text{A}$
		$V_{DS}=560\ \text{V}$ , $T_A=100^\circ\text{C}$			100	$\mu\text{A}$
$t_{D-ON}$	Turn-On Delay Time	$V_{DS}=350\ \text{V}$ , $I_D=1\ \text{A}$ , $R_G=25\ \Omega^{(4)}$		10	30	ns
$t_{D-OFF}$	Turn-Off Delay Time			20	50	ns
$C_{ISS}$	Input Capacitance	$V_{GS}=0\ \text{V}$ , $V_{DS}=25\ \text{V}$ , $f_S=1\ \text{MHz}$		125	150	pF
$C_{OSS}$	Output Capacitance			15	18	pF
<b>Over-Temperature-Protection Section</b>						
$T_{OTP}$	Threshold Temperature for OTP <sup>(5)</sup>			140		$^\circ\text{C}$

**Notes:**

3. These parameters, although guaranteed, are not 100% tested in production.
4. Pulse test: pulsewidth  $\leq 300\ \mu\text{s}$ , duty cycle  $\leq 2\%$ .
5. When the Over-temperature protection is activated, the power system enter latch mode and output is disabled.

## Typical Performance Characteristics

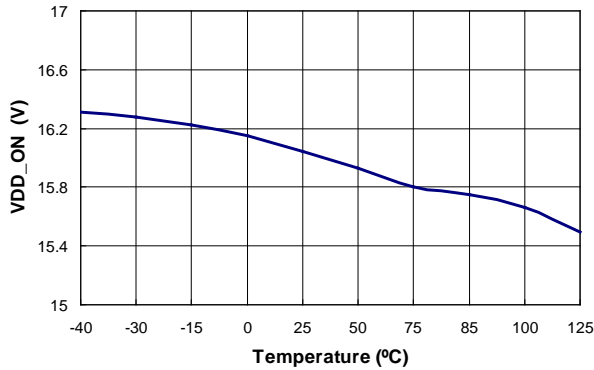

**Figure 6. Turn-On Threshold Voltage ( $V_{DD-ON}$ ) vs. Temperature**

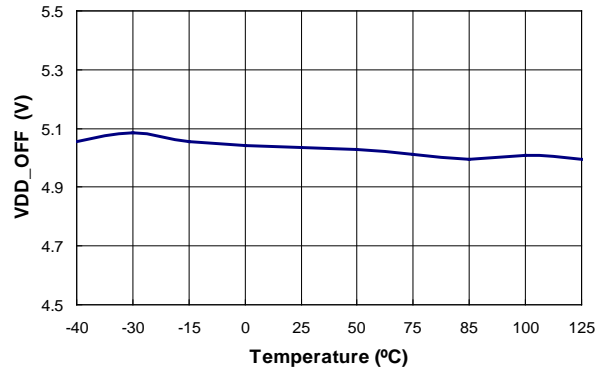

**Figure 7. Turn-Off Threshold Voltage ( $V_{DD-OFF}$ ) vs. Temperature**

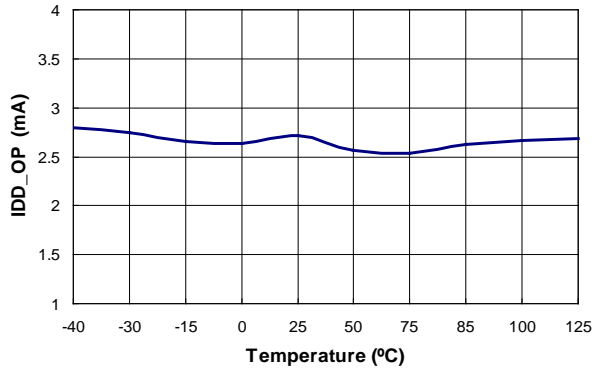

**Figure 8. Operating Current ( $I_{DD-OP}$ ) vs. Temperature**

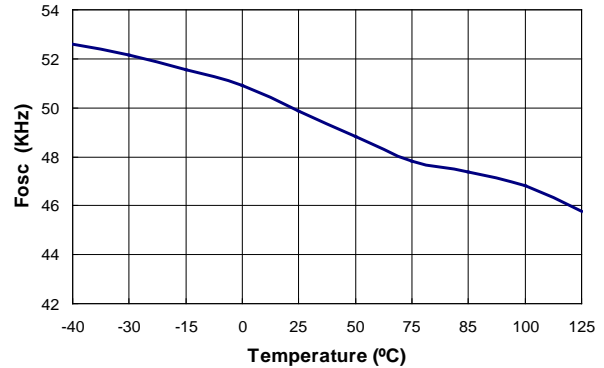

**Figure 9. Center Frequency ( $f_{OSC}$ ) vs. Temperature**

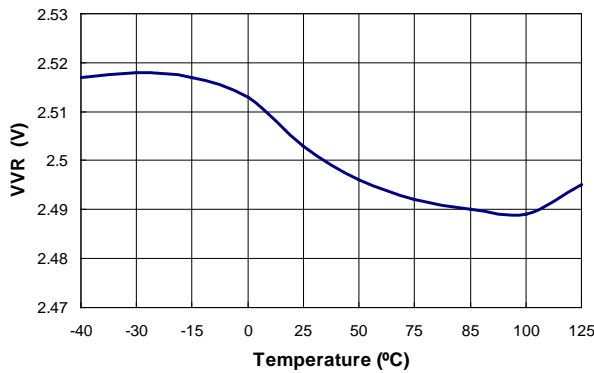

**Figure 10. Reference Voltage ( $V_{VR}$ ) vs. Temperature**

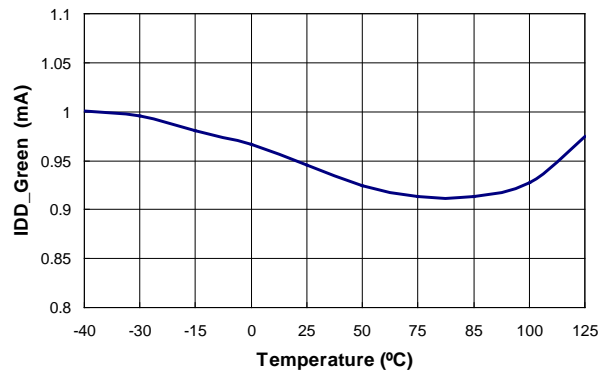

**Figure 11. Green-Mode Operating Supply Current ( $I_{DD-GREEN}$ ) vs. Temperature**

## Typical Performance Characteristics

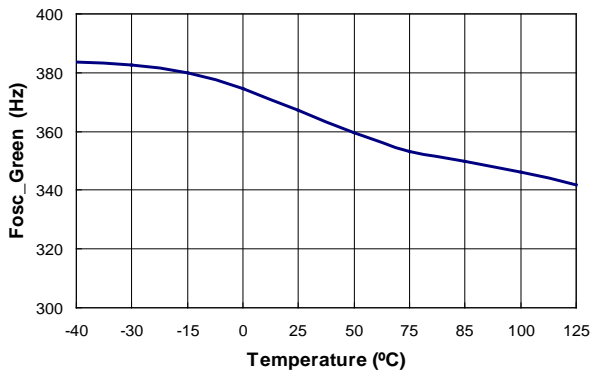

Figure 12. Minimum Frequency at No Load (f<sub>OSC-N-MIN</sub>) vs. Temperature

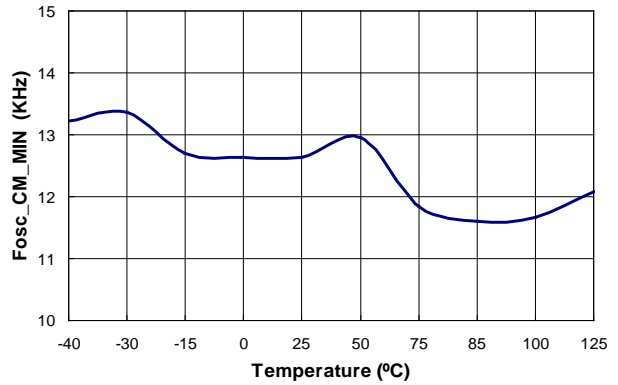

Figure 13. Minimum Frequency at CCM (f<sub>OSC-CM-MIN</sub>) vs. Temperature

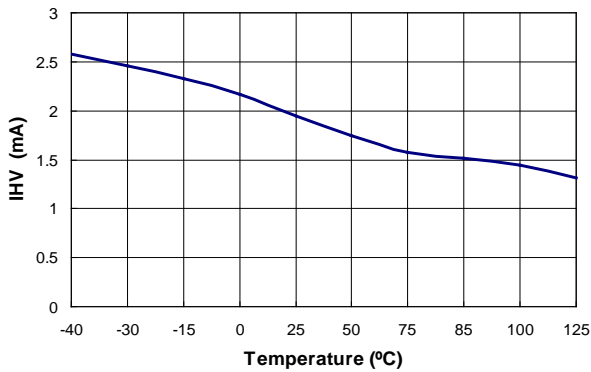

Figure 14. Supply Current Drawn from HV Pin (I<sub>HV</sub>) vs. Temperature

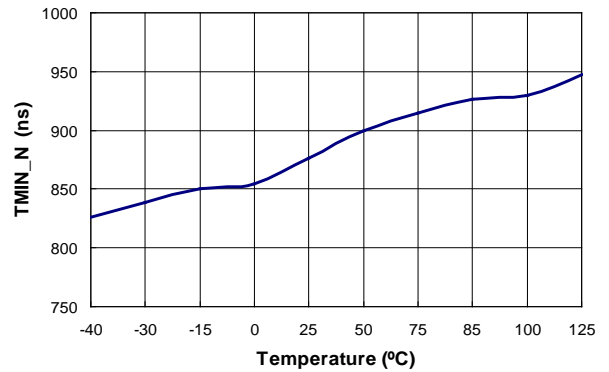

Figure 15. Minimum On Time at No Load (t<sub>MIN-N</sub>) vs. Temperature

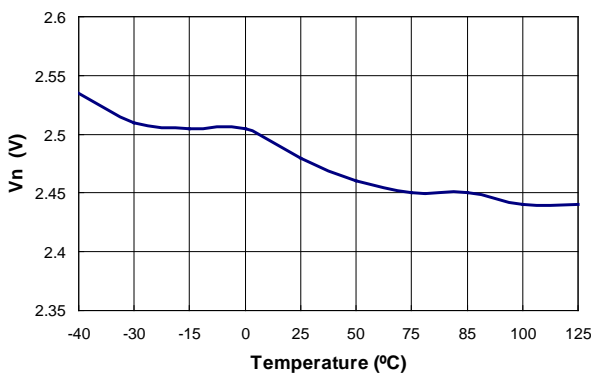

Figure 16. Green-Mode Starting Voltage on EA\_V (V<sub>N</sub>) vs. Temperature

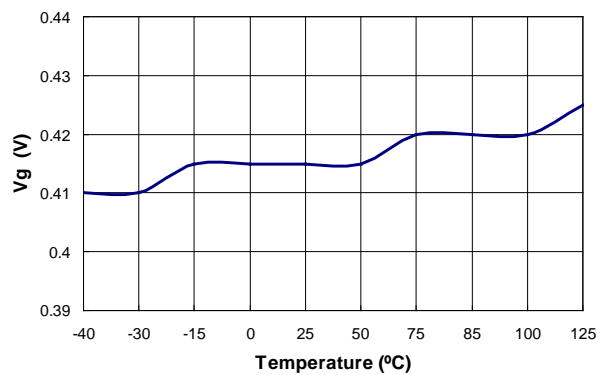

Figure 17. Green-Mode Ending Voltage on EA\_V (V<sub>G</sub>) vs. Temperature



## Typical Performance Characteristics

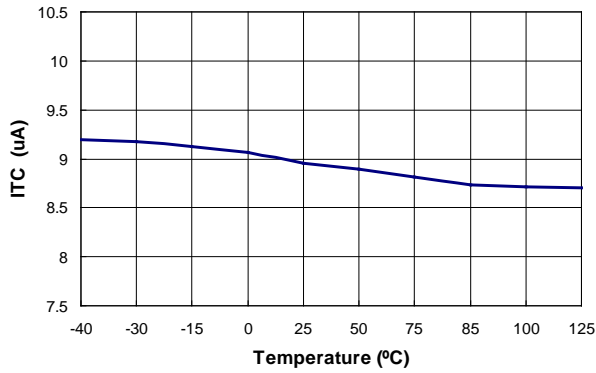

Figure 18. IC Bias Current ( $I_{tC}$ ) vs. Temperature

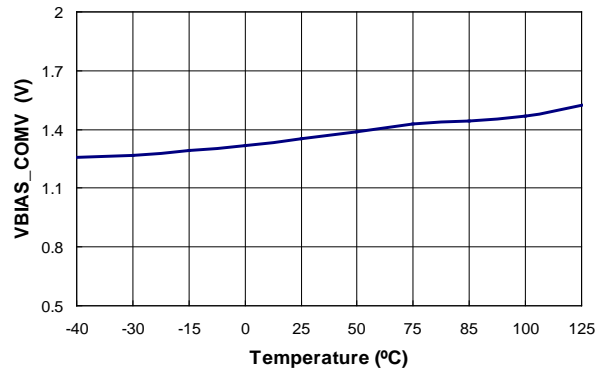

Figure 19. Adaptive Bias Voltage Dominated by  $V_{COMV}$  ( $V_{BIAS-COMV}$ ) vs. Temperature

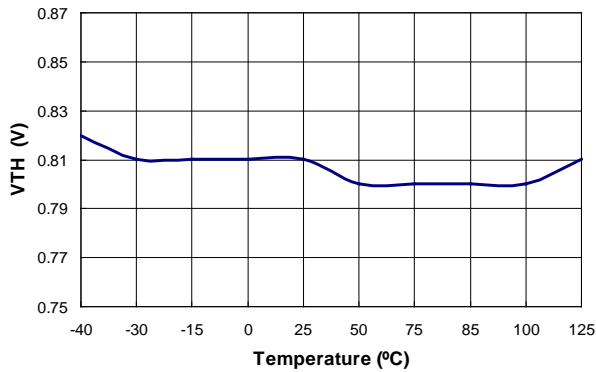

Figure 20. Threshold Voltage for Current Limit ( $V_{TH}$ ) vs. Temperature

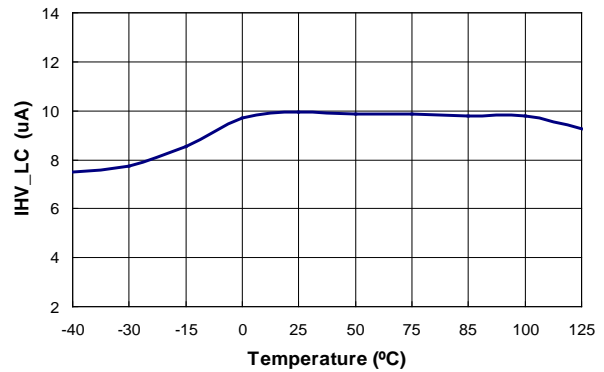

Figure 21. Leakage Current after Startup ( $I_{HV-LC}$ ) vs. Temperature

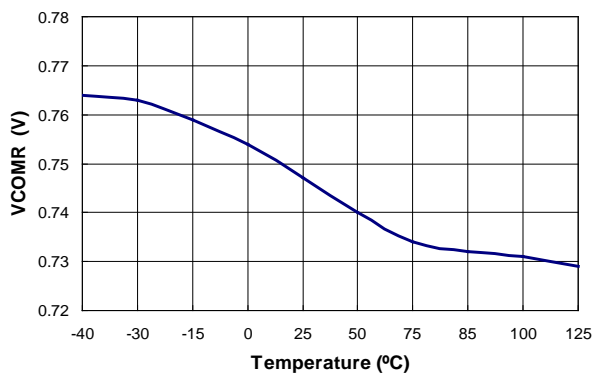

Figure 22. Variation Test Voltage on COMR Pin for Cable Compensation ( $V_{COMR}$ ) vs. Temperature

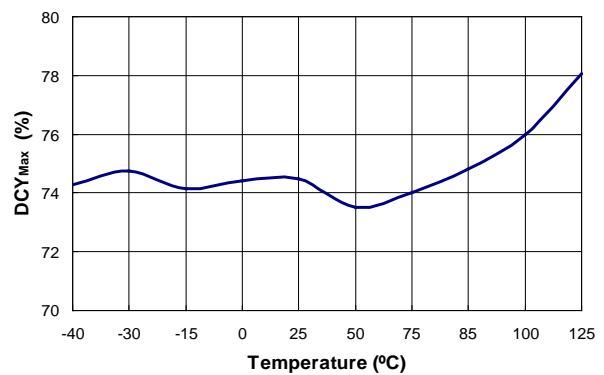

Figure 23. Maximum Duty Cycle ( $DCY_{MAX}$ ) vs. Temperature

## Functional Description

Figure 24 shows the basic circuit diagram of primary-side regulated flyback converter, with typical waveforms shown in Figure 25. Generally, discontinuous conduction mode (DCM) operation is preferred for primary-side regulation because it allows better output regulation. The operation principles of DCM flyback converter are as follows:

During the MOSFET on time ( $t_{ON}$ ), input voltage ( $V_{DL}$ ) is applied across the primary-side inductor ( $L_m$ ). Then MOSFET current ( $I_{ds}$ ) increases linearly from zero to the peak value ( $I_{pk}$ ). During this time, the energy is drawn from the input and stored in the inductor.

When the MOSFET is turned off, the energy stored in the inductor forces the rectifier diode (D) to be turned on. While the diode is conducting, the output voltage ( $V_o$ ), together with diode forward-voltage drop ( $V_F$ ), is applied across the secondary-side inductor ( $L_m \times N_s^2 / N_p^2$ ) and the diode current ( $I_D$ ) decreases linearly from the peak value ( $I_{pk} \times N_p / N_s$ ) to zero. At the end of inductor current discharge time ( $t_{DIS}$ ), all the energy stored in the inductor has been delivered to the output.

When the diode current reaches zero, the transformer auxiliary winding voltage ( $V_w$ ) begins to oscillate by the resonance between the primary-side inductor ( $L_m$ ) and the effective capacitor loaded across the MOSFET.

During the inductor current discharge time, the sum of output voltage and diode forward-voltage drop is reflected to the auxiliary winding side as  $(V_o + V_F) \times N_A / N_s$ . Since the diode forward-voltage drop decreases as current decreases, the auxiliary winding voltage reflects the output voltage best at the end of diode conduction time where the diode current diminishes to zero. Thus, by sampling the winding voltage at the end of the diode conduction time, the output voltage information can be obtained. The internal error amplifier for output voltage regulation (EA\_V) compares the sampled voltage with internal precise reference to generate error voltage ( $V_{COMV}$ ), which determines the duty cycle of the MOSFET in CV mode.

Meanwhile, the output current can be estimated using the peak drain current and inductor current discharge time because output current is same as the average of the diode current in steady state.

The output current estimator picks up the peak value of the drain current with a peak detection circuit and calculates the output current using the inductor discharge time ( $t_{DIS}$ ) and switching period ( $t_s$ ). This output information is compared with internal precise reference to generate the error voltage ( $V_{COMI}$ ), which determines the duty cycle of the MOSFET in CC mode. With Fairchild's innovative TRUECURRENT™ technique, constant current (CC) output can be precisely controlled.

Among the two error voltages,  $V_{COMV}$  and  $V_{COMI}$ , the smaller one determines the duty cycle. Therefore, during

constant voltage regulation mode,  $V_{COMV}$  determines the duty cycle while  $V_{COMI}$  is saturated to HIGH. During constant current regulation mode,  $V_{COMI}$  determines the duty cycle while  $V_{COMV}$  is saturated to HIGH.

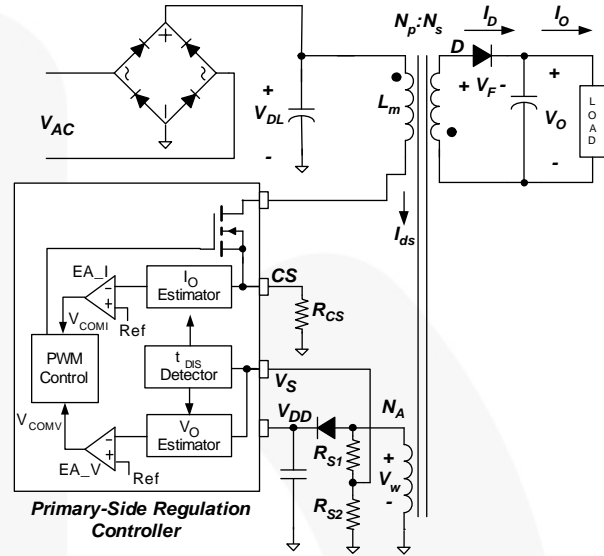

Figure 24. Simplified PSR Flyback Converter Circuit

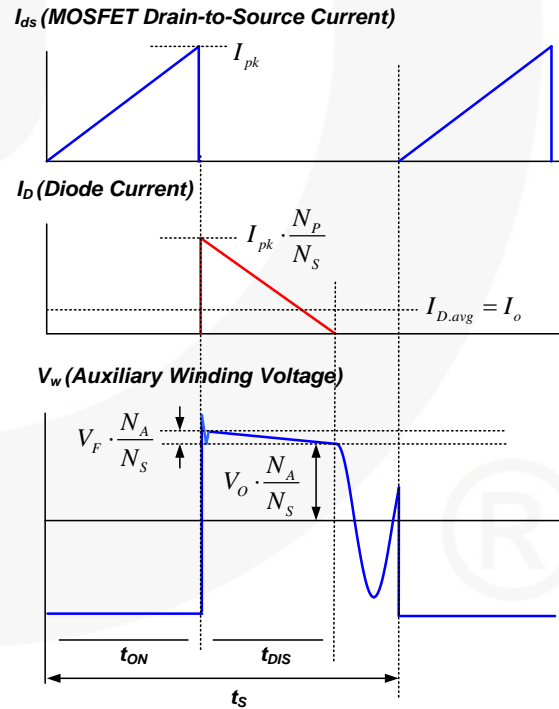

Figure 25. Key Waveforms of DCM Flyback Converter

### Cable Voltage Drop Compensation

In cellular phone charger applications, the battery is located at the end of cable, which typically causes several percentage points of voltage drop on the battery voltage. FSEZ1307 has a built-in cable voltage drop compensation that provides a constant output voltage at the end of the cable over the entire load range in CV mode. As load increases, the voltage drop across the cable is compensated by increasing the reference voltage of the voltage regulation error amplifier.

### Operating Current

The FSEZ1307 operating current is as small as 2.5 mA, which results in higher efficiency and reduces the  $V_{DD}$  hold-up capacitance requirement. Once FSEZ1307 enters “deep” green mode, the operating current is reduced to 0.95 mA, assisting the power supply in meeting power conservation requirements.

### Green-Mode Operation

The FSEZ1307 uses voltage regulation error amplifier output ( $V_{COMV}$ ) as an indicator of the output load and modulates the PWM frequency, as shown in Figure 26. The switching frequency decreases as the load decreases. In heavy load conditions, the switching frequency is fixed at 50 kHz. Once  $V_{COMV}$  decreases below 2.5 V, the PWM frequency linearly decreases from 50 kHz. When FSEZ1307 enters deep green mode, the PWM frequency is reduced to a minimum frequency of 370 Hz, gaining power saving to meet international power conservation requirements.

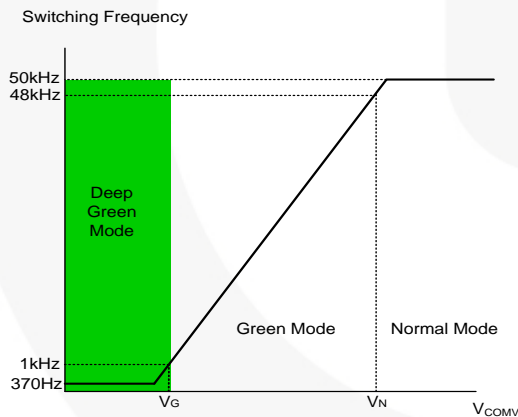

Figure 26. Switching Frequency in Green Mode

### Frequency Hopping

EMI reduction is accomplished by frequency hopping, which spreads the energy over a wider frequency range than the bandwidth measured by the EMI test equipment. FSEZ1307 has an internal frequency hopping circuit that changes the switching frequency between 47 kHz and 53 kHz over the period shown in Figure 27.

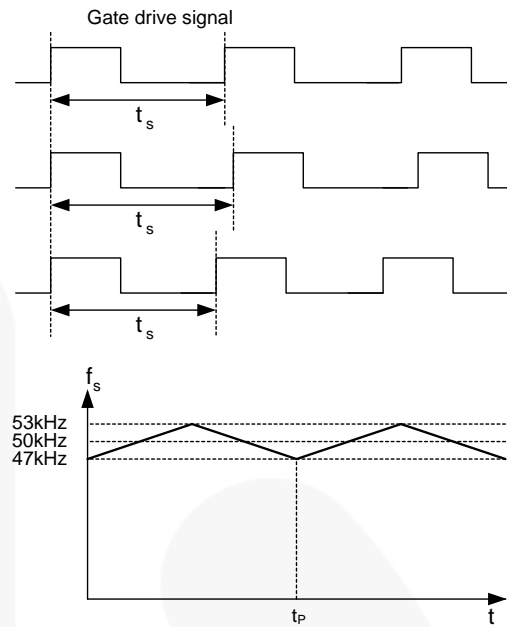

Figure 27. Frequency Hopping

### High-Voltage Startup

Figure 28 shows the HV-startup circuit for FSEZ1307 applications. The HV pin is connected to the line input or bulk capacitor through a resistor,  $R_{START}$  (100 k $\Omega$  recommended). During startup, the internal startup circuit is enabled. Meanwhile, line input supplies the current,  $I_{STARTUP}$ , to charge the hold-up capacitor,  $C_{DD}$ , through  $R_{START}$ . When the  $V_{DD}$  voltage reaches  $V_{DD-ON}$ , the internal startup circuit is disabled, blocking  $I_{STARTUP}$  from flowing into the HV pin. Once the IC turns on,  $C_{DD}$  is the only energy source to supply the IC consumption current before the PWM starts to switch. Therefore,  $C_{DD}$  must be large enough to prevent  $V_{DD}$  from dropping down to  $V_{DD-OFF}$  before the power can be delivered from the auxiliary winding.

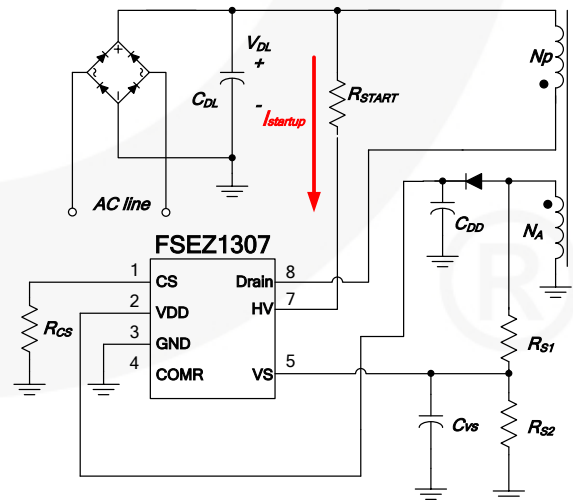

Figure 28. HV Startup Circuit

## Under-Voltage Lockout (UVLO)

The turn-on and turn-off thresholds are fixed internally at 16 V and 5 V, respectively. During startup, the hold-up capacitor must be charged to 16 V through the startup resistor to enable the FSEZ1307. The hold-up capacitor continues to supply  $V_{DD}$  until power can be delivered from the auxiliary winding of the main transformer.  $V_{DD}$  is not allowed to drop below 5 V during this startup process. This UVLO hysteresis window ensures that hold-up capacitor properly supplies  $V_{DD}$  during startup.

## Protections

The FSEZ1307 has several self-protection functions, such as Over-Voltage Protection (OVP), Over-Temperature Protection (OTP), and pulse-by-pulse current limit. All the protections are implemented as auto-restart mode. Once the abnormal condition occurs, the switching is terminated and the MOSFET remains off, causing  $V_{DD}$  to drop. When  $V_{DD}$  drops to the  $V_{DD}$  turn-off voltage of 5 V, the internal startup circuit is enabled again and the supply current drawn from the HV pin charges the hold-up capacitor. When  $V_{DD}$  reaches the turn-on voltage of 16 V, normal operation resumes. In this manner, the auto-restart alternately enables and disables the switching of the MOSFET until the abnormal condition is eliminated (see Figure 29).

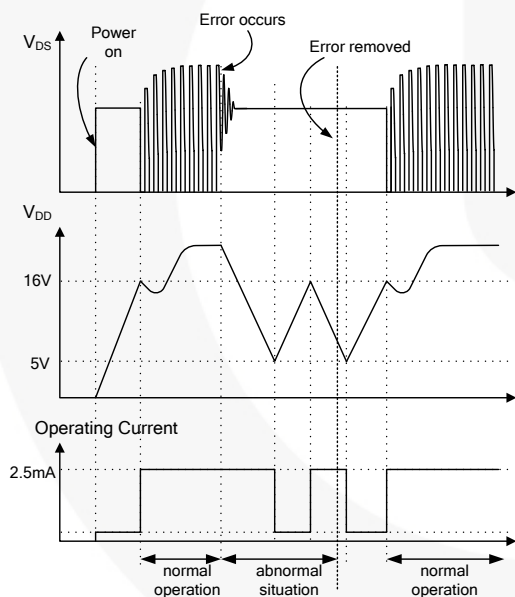

Figure 29. Auto-Restart Operation

## $V_{DD}$ Over-Voltage Protection (OVP)

$V_{DD}$  over-voltage protection prevents damage from over-voltage conditions. If the  $V_{DD}$  voltage exceeds 24 V at open-loop feedback condition, OVP is triggered and the PWM switching is disabled. The OVP has a debounce time (typically 200  $\mu$ s) to prevent false triggering due to switching noises.

## Over-Temperature Protection (OTP)

The built-in temperature-sensing circuit shuts down PWM output if the junction temperature exceeds 140°C.

## Pulse-by-Pulse Current Limit

When the sensing voltage across the current-sense resistor exceeds the internal threshold of 0.8 V, the MOSFET is turned off for the remainder of switching cycle. In normal operation, the pulse-by-pulse current limit is not triggered since the peak current is limited by the control loop.

## Leading-Edge Blanking (LEB)

Each time the power MOSFET switches on, a turn-on spike occurs at the sense resistor. To avoid premature termination of the switching pulse, a leading-edge blanking time is built in. During this blanking period, the current-limit comparator is disabled and cannot switch off the gate driver. As a result, conventional RC filtering can be omitted.

## Gate Output

The FSEZ1307 output stage is a fast totem-pole gate driver. Cross conduction has been avoided to minimize heat dissipation, increase efficiency, and enhance reliability. The output driver is clamped by an internal 15 V Zener diode to protect the power MOSFET transistors against undesired over-voltage gate signals.

## Built-In Slope Compensation

The sensed voltage across the current-sense resistor is used for current mode control and pulse-by-pulse current limiting. Built-in slope compensation improves stability and prevents sub-harmonic oscillations due to peak-current mode control. The FSEZ1307 has a synchronized, positive-slope ramp built-in at each switching cycle.

## Noise Immunity

Noise from the current sense or the control signal can cause significant pulsewidth jitter, particularly in continuous-conduction mode. While slope compensation helps alleviate these problems, further precautions should still be taken. Good placement and layout practices should be followed. Avoiding long PCB traces and component leads, locating compensation and filter components near the FSEZ1307, and increasing the power MOS gate resistance are advised.

## Typical Application Circuit (Primary-Side Regulated Flyback Charger)

Application	Fairchild Device	Input Voltage Range	Output	Output DC cable
Cell Phone Charger	FSEZ1307	90~265 V <sub>AC</sub>	5 V/0.7 A (3.5 W)	AWG26, 1.8 Meter

### Features

- High efficiency (>65.5% at full load) meeting EPS 2.0 regulation with enough margin
- Low standby (Pin<30 mW at no-load condition)

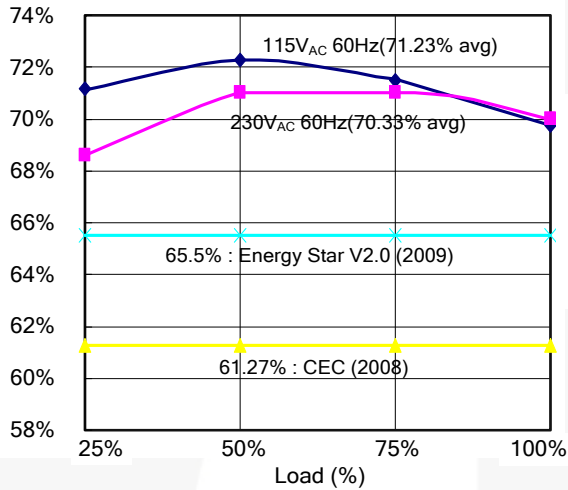

Figure 30. Measured Efficiency

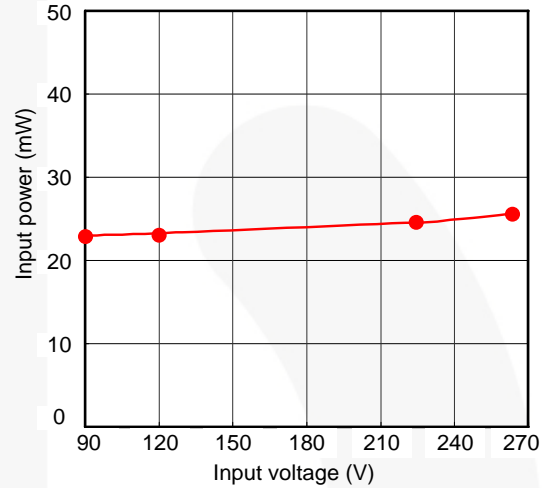

Figure 31. Standby Power

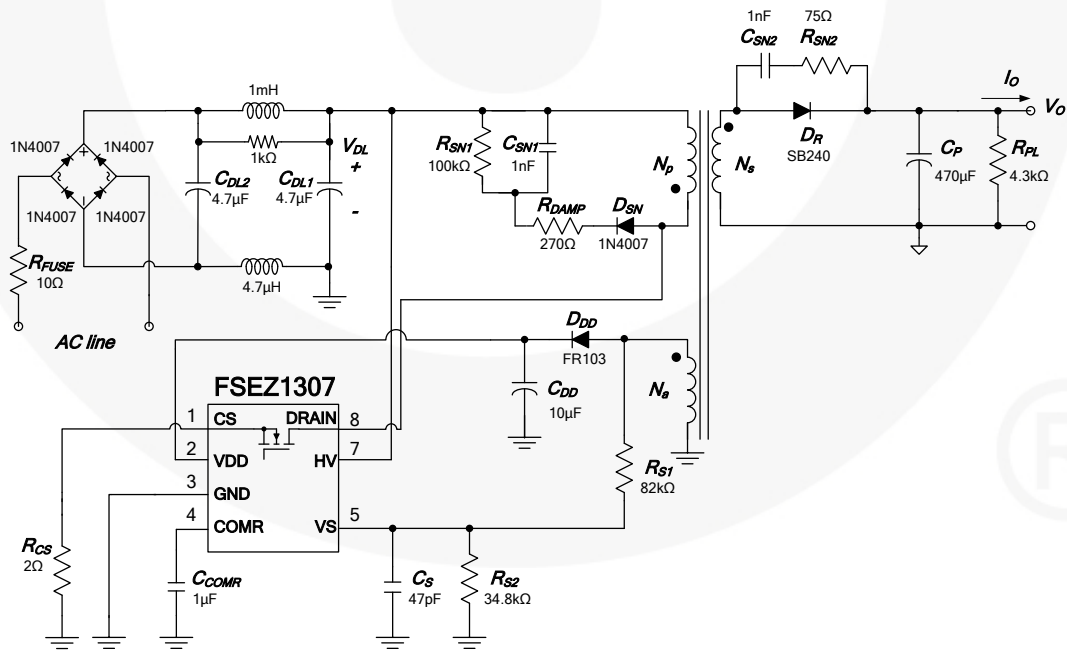
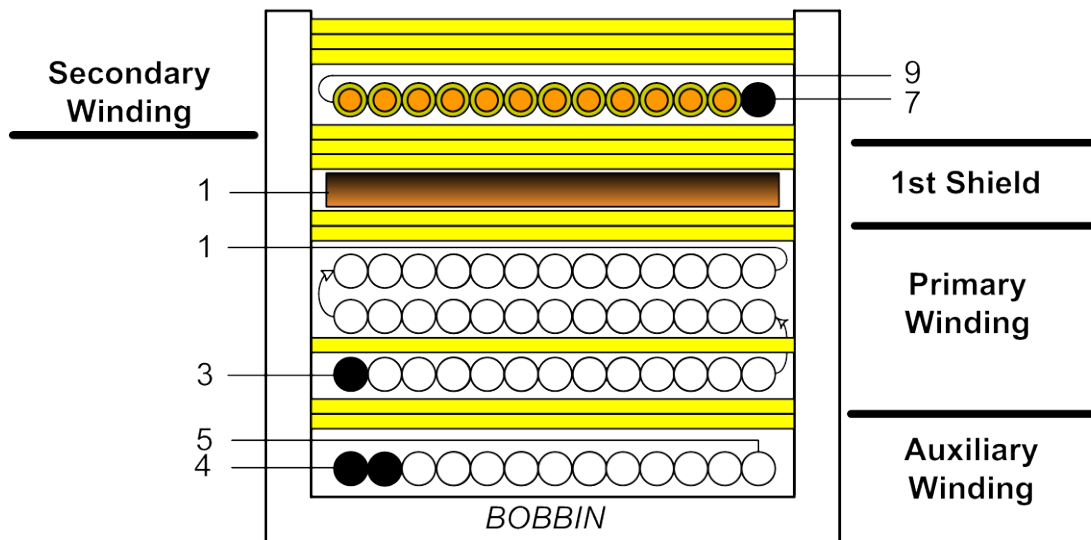

Figure 32. Schematic of Typical Application Circuit

### Typical Application Circuit (Continued)

#### Transformer Specification

- Core: EE16
- Bobbin: EE16



**Note**

6. 1
7. When W2 is winding, it must wind three layers and put one layer of tape after winding the first layer.

NO	TERMINAL		WIRE	t <sub>s</sub>	INSULATION t <sub>s</sub>	BARRIER TAPE	
	S	F				Primary	Seconds
W1	4	5	2UEW 0.23*2	15	2		
W2	3	1	2UEW 0.17*1	41	1		
				39	0		
				37	2		
W3	1		COPPER SHIELD	1.2	3		
W4	7	9	TEX-E 0.55*1	9	3		
			CORE ROUNDING TAPE		3		

	Pin	Specification	Remark
Primary-Side Inductance	1 – 3	2.25 mH ± 7%	100 kHz, 1 V
Primary-Side Effective Leakage	1 – 3	80μH ± 5%	Short One of the Secondary Windings

## Physical Dimensions

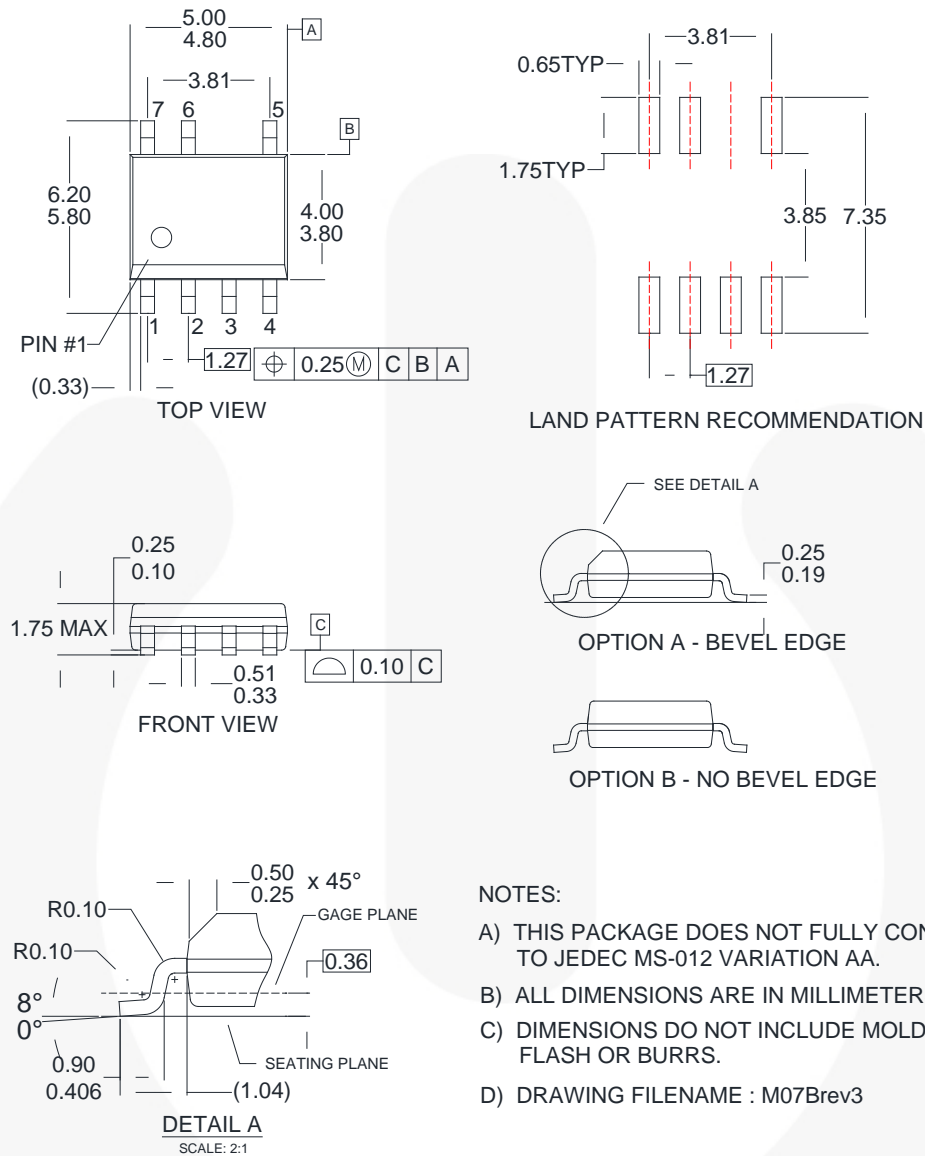

**Figure 34. 7-Lead, Small Outline Package (SOP-7)**

Package drawings are provided as a service to customers considering Fairchild components. Drawings may change in any manner without notice. Please note the revision and/or date on the drawing and contact a Fairchild Semiconductor representative to verify or obtain the most recent revision. Package specifications do not expand the terms of Fairchild's worldwide terms and conditions, specifically the warranty therein, which covers Fairchild products.

Always visit Fairchild Semiconductor's online packaging area for the most recent package drawings:  
<http://www.fairchildsemi.com/packaging/>.



**TRADEMARKS**

The following includes registered and unregistered trademarks and service marks, owned by Fairchild Semiconductor and/or its global subsidiaries, and is not intended to be an exhaustive list of all such trademarks.

- |  |  |   |   |
|--|--|---|---|
| AccuPower™   | F-PFST™  | PowerTrench®  | Sync-Lock™  |
| AX-CAP®  | FRFET®   | PowerIX™  |  SYSTEM GENERAL® |
| BitSiC™  | Global Power Resource®                         | Programmable Active Droop™  | TinyBoost®  |
| Build it Now™  | GreenBridge™                                   | QFET®   | TinyBuck®   |
| CorePLUS™  | Green FPS™                                     | QST™  | TinyCalc™   |
| CorePOWER™   | Green FPS™ e-Series™                           | Quiet Series™   | TINYOPTO™   |
| CROSSVOLT™   | Gmax™  | RapidConfigure™   | TinyPower™  |
| CTL™   | GTO™   |  Saving our world, 1mW/W/kW at a time™ | TinyPWM™  |
| Current Transfer Logic™  | IntelliMAX™                                    | SignalWise™   | TinyWire™   |
| DEUXPEED®  | ISOPLANAR™                                     | SmartMax™   | TranSiC™  |
| Dual Cool™   | Making Small Speakers Sound Louder and Better™ | SMART START™  | TriFault Detect™  |
| EcoSPARK®  | MegaBuck™                                      | Solutions for Your Success™   | TRUECURRENT®  |
| EfficientMax™  | MICROCOUPLER™                                  | SPM®  | µSerDes™  |
| ESBC™  | MicroFET™                                      | STEALTH™  |  SerDes®         |
|  Fairchild® | MicroPak™                                      | SuperFET®   | UHC®  |
| Fairchild Semiconductor®   | MicroPak2™                                     | SuperSOT™-3   | Ultra FRFET™  |
| FACT Quiet Series™   | MillerDrive™                                   | SuperSOT™-6   | UniFET™   |
| FACT®  | MotionMax™                                     | SuperSOT™-8   | VCX™  |
| FAST®  | mWSaver®                                       | SupreMOS®   | VisualMax™  |
| FastvCore™   | OptoHIT™                                       | SyncFET™  | VoltagePlus™  |
| FETBench™  | OPTOLOGIC®                                     |   | XS™   |
| FPS™   | OPTOPLANAR®                                    |   |   |

\* Trademarks of System General Corporation, used under license by Fairchild Semiconductor.

**DISCLAIMER**

FAIRCHILD SEMICONDUCTOR RESERVES THE RIGHT TO MAKE CHANGES WITHOUT FURTHER NOTICE TO ANY PRODUCTS HEREIN TO IMPROVE RELIABILITY, FUNCTION, OR DESIGN. FAIRCHILD DOES NOT ASSUME ANY LIABILITY ARISING OUT OF THE APPLICATION OR USE OF ANY PRODUCT OR CIRCUIT DESCRIBED HEREIN; NEITHER DOES IT CONVEY ANY LICENSE UNDER ITS PATENT RIGHTS, NOR THE RIGHTS OF OTHERS. THESE SPECIFICATIONS DO NOT EXPAND THE TERMS OF FAIRCHILD'S WORLDWIDE TERMS AND CONDITIONS, SPECIFICALLY THE WARRANTY THEREIN, WHICH COVERS THESE PRODUCTS.

**LIFE SUPPORT POLICY**

FAIRCHILD'S PRODUCTS ARE NOT AUTHORIZED FOR USE AS CRITICAL COMPONENTS IN LIFE SUPPORT DEVICES OR SYSTEMS WITHOUT THE EXPRESS WRITTEN APPROVAL OF FAIRCHILD SEMICONDUCTOR CORPORATION.

As used herein:

1. Life support devices or systems are devices or systems which, (a) are intended for surgical implant into the body or (b) support or sustain life, and (c) whose failure to perform when properly used in accordance with instructions for use provided in the labeling, can be reasonably expected to result in a significant injury of the user.
2. A critical component in any component of a life support, device, or system whose failure to perform can be reasonably expected to cause the failure of the life support device or system, or to affect its safety or effectiveness.

**ANTI-COUNTERFEITING POLICY**

Fairchild Semiconductor Corporation's Anti-Counterfeiting Policy. Fairchild's Anti-Counterfeiting Policy is also stated on our external website, [www.fairchildsemi.com](http://www.fairchildsemi.com), under Sales Support.

Counterfeiting of semiconductor parts is a growing problem in the industry. All manufacturers of semiconductor products are experiencing counterfeiting of their parts. Customers who inadvertently purchase counterfeit parts experience many problems such as loss of brand reputation, substandard performance, failed applications, and increased cost of production and manufacturing delays. Fairchild is taking strong measures to protect ourselves and our customers from the proliferation of counterfeit parts. Fairchild strongly encourages customers to purchase Fairchild parts either directly from Fairchild or from Authorized Fairchild Distributors who are listed by country on our web page cited above. Products customers buy either from Fairchild directly or from Authorized Fairchild Distributors are genuine parts, have full traceability, meet Fairchild's quality standards for handling and storage and provide access to Fairchild's full range of up-to-date technical and product information. Fairchild and our Authorized Distributors will stand behind all warranties and will appropriately address any warranty issues that may arise. Fairchild will not provide any warranty coverage or other assistance for parts bought from Unauthorized Sources. Fairchild is committed to combat this global problem and encourage our customers to do their part in stopping this practice by buying direct or from authorized distributors.

**PRODUCT STATUS DEFINITIONS**

**Definition of Terms**

Datasheet Identification	Product Status	Definition
Advance Information	Formative / In Design	Datasheet contains the design specifications for product development. Specifications may change in any manner without notice.
Preliminary	First Production	Datasheet contains preliminary data; supplementary data will be published at a later date. Fairchild Semiconductor reserves the right to make changes at any time without notice to improve design.
No Identification Needed	Full Production	Datasheet contains final specifications. Fairchild Semiconductor reserves the right to make changes at any time without notice to improve the design.
Obsolete	Not In Production	Datasheet contains specifications on a product that is discontinued by Fairchild Semiconductor. The datasheet is for reference information only.

Rev. 166