



# FAN6604 Highly Integrated Green-Mode PWM Controller

## Features

- High-Voltage Startup
- AC Input Brownout Protection with Hysteresis
- Line Compensation by Current Limit
- Low Operating Current: 1.5 mA
- Linearly Decreasing PWM Frequency to 22 kHz with Cycle Skipping
- Frequency Hopping to Reduce EMI Emission
- Fixed PWM Frequency: 65 kHz
- Peak-Current-Mode Control
- Cycle-by-Cycle Current Limiting
- Leading-Edge Blanking (LEB)
- Internal Open-Loop Protection
- GATE Output Maximum Voltage Clamp: 13 V
- V<sub>DD</sub> Under-Voltage Lockout (UVLO)
- V<sub>DD</sub> Over-Voltage Protection (OVP)
- Programmable Over-Temperature Protection (OTP)
- Internal Latch Circuit (OVP, OTP)
- Open-Loop Protection (OLP); Restart for FAN6604MRMX, Latch for FAN6604MLMX
- SENSE Short-Circuit Protection (SSCP)
- Built-in 8 ms Soft-Start Function

## Applications

General-purpose switch-mode power supplies (SMPS) and flyback power converters, including:

- Power Adapters

## Description

The highly integrated FAN6604 PWM controller provides several features to enhance the performance of flyback converters. To minimize standby power consumption, a proprietary Green-Mode function provides off-time modulation to continuously decrease the switching frequency under light-load conditions.

Under zero-load and very light-load conditions, FAN6604 saves PWM pulses by entering "deep" Burst Mode. Burst Mode enables the power supply to meet international power conservation requirements.

FAN6604 also integrates a frequency-hopping function that helps reduce EMI emission of a power supply with minimum line filters. The built-in synchronized slope compensation helps achieve stable peak-current control. Add in current limit to keep constant output power over universal AC input range. The gate output is clamped at 13 V to protect the external MOSFET from over-voltage damage.

Other protection functions include AC input brownout protection with hysteresis, sense pin short-circuit protection, and V<sub>DD</sub> over-voltage protection. For over-temperature protection, an external NTC thermistor can be applied to sense the external switcher's temperature. When V<sub>DD</sub> OVP or OTP are activated, an internal latch circuit is used to latch-off the controller. The Latch Mode is reset when the V<sub>DD</sub> supply is removed.

FAN6604 is available in an 8-pin SOP package.

## Ordering Information

Part Number	Operating Temperature Range	Package	Packing Method
FAN6604MRMX	-40 to +105°C	8-Pin, Small Outline Package (SOP)	Tape & Reel
FAN6604MLMX			

### Application Diagram

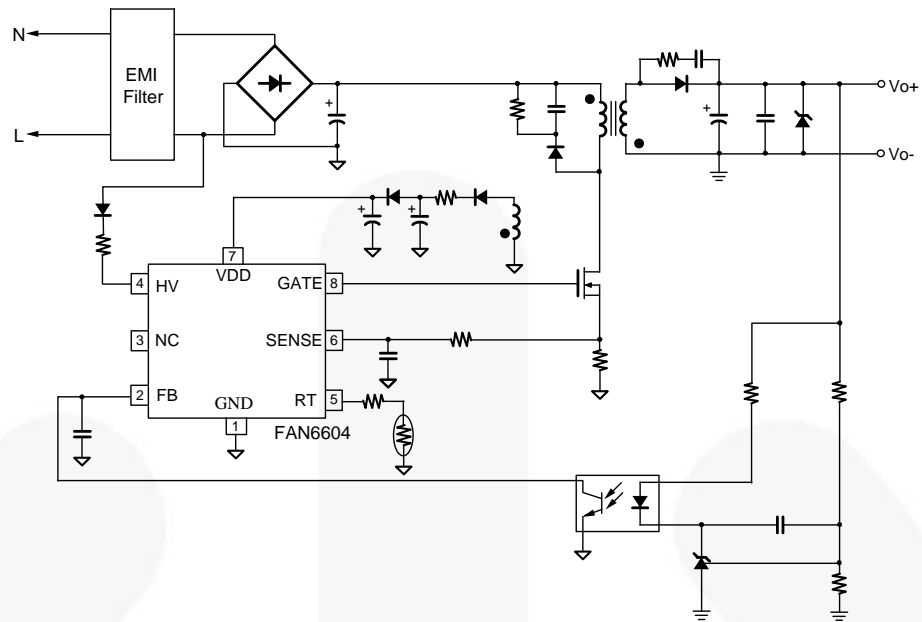

Figure 1. Typical Application

### Internal Block Diagram

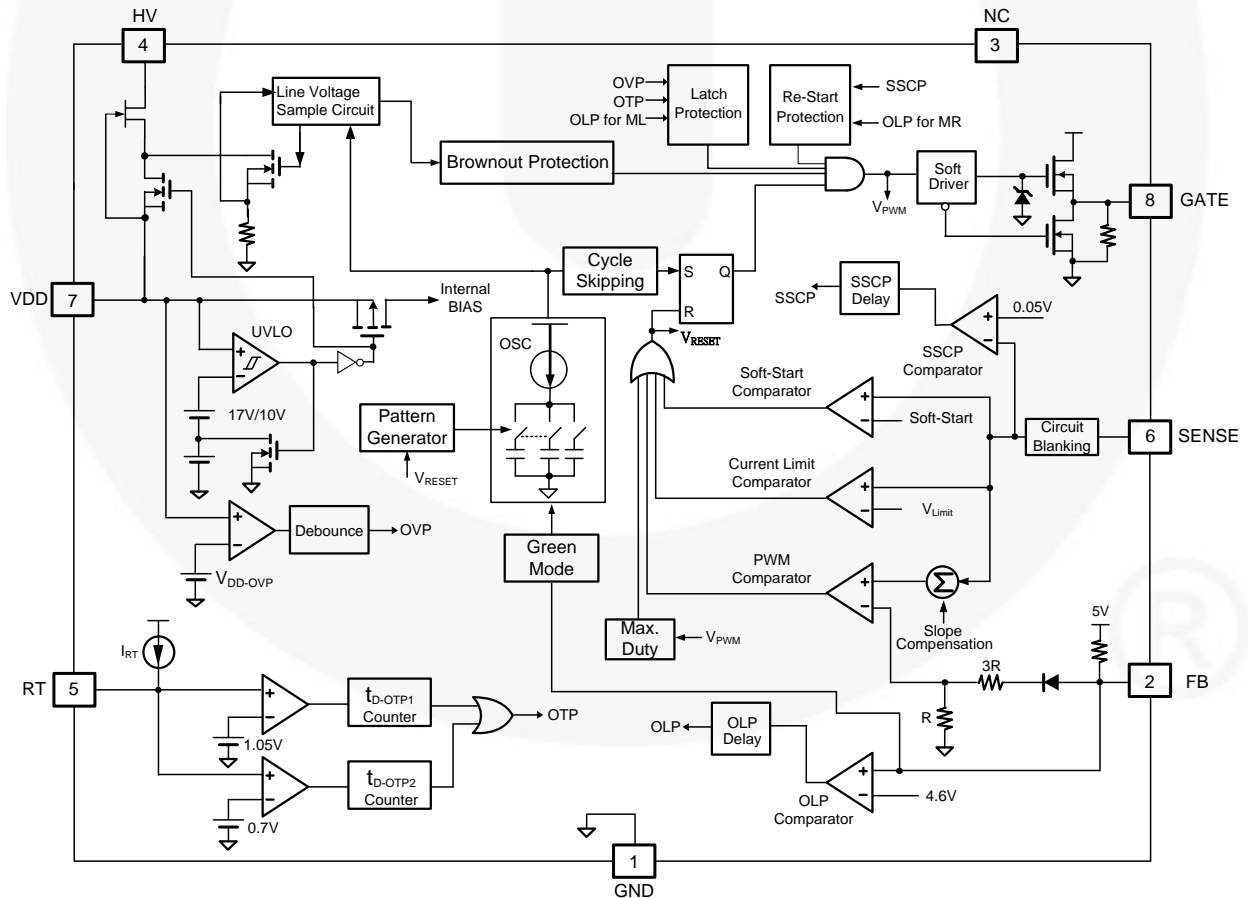

Figure 2. Functional Block Diagram

## Marking Information

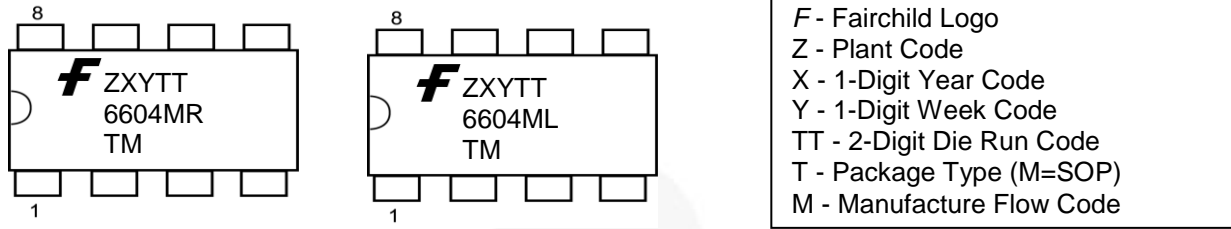

Figure 3. Top Mark

## Pin Configuration

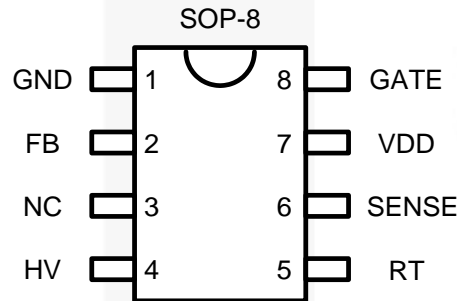

Figure 4. Pin Configuration (Top View)

## Pin Definitions

Pin #	Name	Description
1	GND	<b>Ground.</b> This pin is used for the ground potential of all the pins. A 0.1 $\mu$ F decoupling capacitor placed between VDD and GND is recommended.
2	FB	<b>Feedback.</b> The output voltage feedback information from the external compensation circuit is fed into this pin. The PWM duty cycle is determined by this pin and the current-sense signal from Pin 6. FAN6604 performs open-loop protection (OLP); if the FB voltage is higher than a threshold voltage (around 4.6 V) for more than 56 ms, the controller latches off the PWM.
3	NC	<b>No Connection</b>
4	HV	<b>High-Voltage Startup.</b> This pin is connected to the line input via a 1N4007 and 200 k $\Omega$ resistor to achieve brownout. Once the voltage on the HV pin is lower than the brownout voltage, PWM output turns off.
5	RT	<b>Over-Temperature Protection.</b> An external NTC thermistor is connected from this pin to GND. The impedance of the NTC decreases at high temperatures. Once the voltage on the RT pin drops below the threshold voltage, the controller latches off the PWM. If RT pin is not connected to an NTC resistor for Over-Temperature Protection, a 100 k $\Omega$ resistor is recommend to connect the RT pin to the GND pin. This pin is limited by an internal clamping circuit.
6	SENSE	<b>Current Sense.</b> This pin is used to sense the MOSFET current for the current-mode PWM and current limiting. To achieve high/low line compensation, current limit is built-in.
7	VDD	<b>Supply Voltage.</b> IC operating current and MOSFET driving current are supplied using this pin. This pin is connected to an external bulk capacitor of typically 47 $\mu$ F. The threshold voltages for turn-on and turn-off are 17 V and 10 V, respectively. The operating current is lower than 2 mA.
8	GATE	<b>Gate Drive Output.</b> The totem-pole output driver for the power MOSFET. It is internally clamped below 13 V.

## Absolute Maximum Ratings

Stresses exceeding the absolute maximum ratings may damage the device. The device may not function or be operable above the recommended operating conditions and stressing the parts to these levels is not recommended. In addition, extended exposure to stresses above the recommended operating conditions may affect device reliability. The absolute maximum ratings are stress ratings only.

Symbol	Parameter		Min.	Max.	Unit
V <sub>VDD</sub>	DC Supply Voltage <sup>(1,2)</sup>			30	V
V <sub>FB</sub>	FB Pin Input Voltage		-0.3	6.0	V
V <sub>SENSE</sub>	SENSE Pin Input Voltage		-0.3	6.0	V
V <sub>RT</sub>	RT Pin Input Voltage		-0.3	6.0	V
V <sub>HV</sub>	HV Pin Input Voltage			500	V
P <sub>D</sub>	Power Dissipation (T <sub>A</sub> < 50°C)			400	mW
Θ <sub>JA</sub>	Thermal Resistance (Junction-to-Air)			150	°C/W
T <sub>J</sub>	Operating Junction Temperature		-40	+125	°C
T <sub>STG</sub>	Storage Temperature Range		-55	+150	°C
T <sub>L</sub>	Lead Temperature (Wave Soldering or IR, 10 Seconds)			+260	°C
ESD	Electrostatic Discharge Capability, All Pins Except HV Pin	Human Body Model; JESD22-A114		5000	V
		Charged Device Model; JESD22-C101		2000	

### Notes:

- All voltage values, except differential voltages, are given with respect to the network ground terminal.
- Stresses beyond those listed under Absolute Maximum Ratings may cause permanent damage to the device.
- ESD with HV pin: CDM=1000 V and HBM=1000 V.

## Recommended Operating Conditions

The Recommended Operating Conditions table defines the conditions for actual device operation. Recommended operating conditions are specified to ensure optimal performance to the datasheet specifications. Fairchild does not recommend exceeding them or designing to Absolute Maximum Ratings.

Symbol	Parameter	Min.	Typ.	Max.	Unit
R <sub>HV</sub>	HV Startup Resistor	150	200	250	kΩ

## Electrical Characteristics

$V_{DD}=11\sim 24\text{ V}$  and  $T_A=-40\sim 105^\circ\text{C}$  unless otherwise noted.

Symbol	Parameter	Condition	Min.	Typ.	Max.	Unit
<b>V<sub>DD</sub> Section</b>						
$V_{OP}$	Continuously Operating Voltage				24	V
$V_{DD-ON}$	Start Threshold Voltage		16	17	18	V
$V_{DD-OFF}$	Minimum Operating Voltage		9	10	11	V
$V_{DD-OLP}$	$I_{DD-OLP}$ Off Voltage		5	6.5	8	V
$V_{DD-LH}$	Threshold Voltage on VDD Pin for Latch-Off Release Voltage		3.5	4.0	4.5	V
$V_{DD-AC}$	Threshold Voltage on VDD Pin for Disable AC Recovery to Avoid Startup Failed		$V_{DD-OFF}+2.8$	$V_{DD-OFF}+3.3$	$V_{DD-OFF}+3.8$	V
$I_{DD-ST}$	Startup Current	$V_{DD-ON} - 0.16\text{ V}$			30	$\mu\text{A}$
$I_{DD-OP1}$	Operating Supply Current, PWM Operation	$V_{DD}=20\text{ V}$ , $\text{FB}=3\text{ V}$ Gate Open		1.5	2.0	mA
$I_{DD-OP2}$	Operating Supply Current, Gate Stop	$V_{DD}=20\text{ V}$ , $\text{FB}=3\text{ V}$		1.0	1.5	mA
$I_{LH}$	Operating Current at PWM-Off Phase Under Latch-Off Conduction	$V_{DD}=5\text{ V}$	30	60	90	$\mu\text{A}$
$I_{DD-OLP}$	Internal Sink Current Under Latch-Off Conduction	$V_{DD-OLP}+0.1\text{ V}$ , $T_A=25^\circ\text{C}$	150	180	210	$\mu\text{A}$
$V_{DD-OVP}$	$V_{DD}$ Over-Voltage Protection		24	25	26	V
$t_{D-VDDOVP}$	$V_{DD}$ Over-Voltage Protection Debounce Time		90	180	270	$\mu\text{s}$
<b>HV Section</b>						
$I_{HV}$	Supply Current from HV Pin	$V_{AC}=90\text{ V}$ ( $V_{DC}=120\text{ V}$ ), $V_{DD}=0\text{ V}$ , $T_A=25^\circ\text{C}$	2.0	3.5	5.0	mA
$I_{HV-LC}$	Leakage Current after Startup	$\text{HV}=500\text{ V}$ , $V_{DD}=V_{DD-OFF}+1\text{ V}$		1	20	$\mu\text{A}$
$V_{AC-OFF}$	Brownout Threshold	DC Source Series $R=200\text{ k}\Omega$ to HV Pin See Equation (1)	92	102	112	V
$V_{AC-ON}$	Brown-In Threshold	DC Source Series $R=200\text{ k}\Omega$ to HV Pin See Equation (2)	104	114	124	V
$\Delta V_{AC}$	$V_{AC-ON} - V_{AC-OFF}$	DC Source Series $R=200\text{ k}\Omega$ to HV Pin	6	12	18	V
$t_{S-CYCLE}$	Line Voltage Sample Cycle <sup>(4)</sup>	$\text{FB} > V_{\text{FB-N}}$		220		$\mu\text{s}$
		$\text{FB} < V_{\text{FB-G}}$		650		
$t_{H-TIME}$	Line Voltage Hold Period <sup>(4)</sup>			20		$\mu\text{s}$
$t_{D-AC-OFF}$	PWM Turn-off Debounce Time	$\text{FB} > V_{\text{FB-N}}$	58	70	82	ms
		$\text{FB} < V_{\text{FB-G}}$	150	200	250	ms

**Note:**

4. Guaranteed by design.

Continued on the following page...

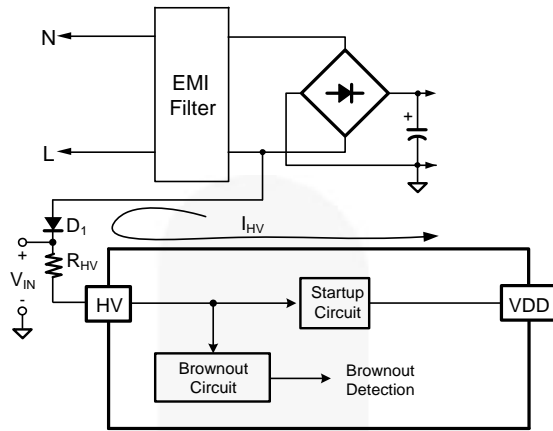

Figure 5. Brownout Circuit

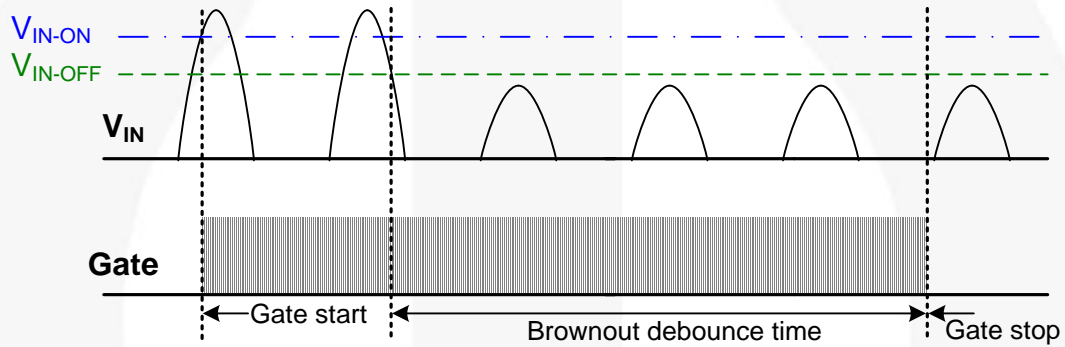

Figure 6. Brownout Behavior

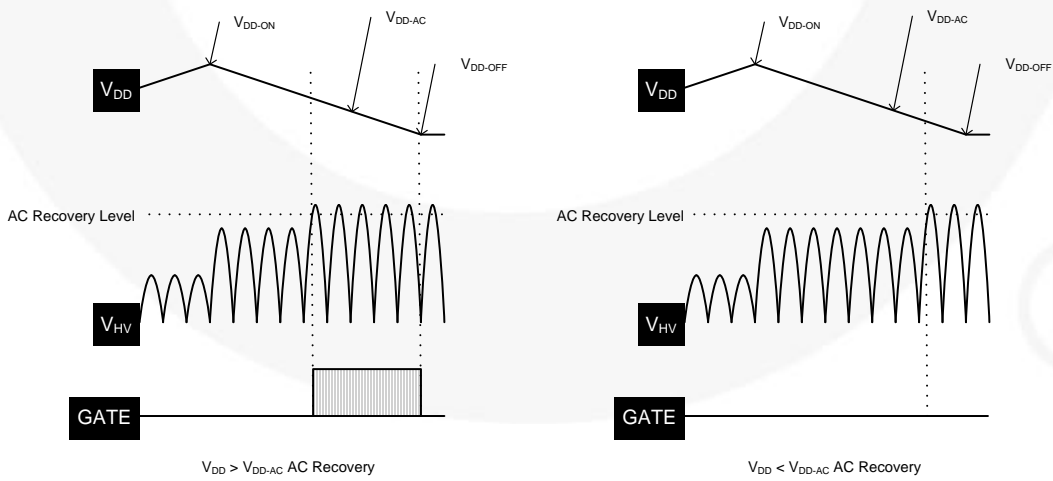

Figure 7.  $V_{DD-AC}$  and AC Recovery

### Electrical Characteristics (Continued)

$V_{DD}=11\sim 24\text{ V}$  and  $T_A=-40\sim 105^\circ\text{C}$  unless otherwise noted.

Symbol	Parameter	Conditions	Min.	Typ.	Max.	Unit
<b>Oscillator Section</b>						
$f_{OSC}$	Frequency in Normal Mode	Center Frequency, $T_A=25^\circ\text{C}$	61	65	69	kHz
		Hopping Range	$\pm 3.7$	$\pm 4.2$	$\pm 4.7$	
$t_{HOP}$	Hopping Period		12.0	13.5	15.0	ms
$f_{OSC-G}$	Green-Mode Frequency		19	22	25	kHz
$f_{DV}$	Frequency Variation vs. $V_{DD}$ Deviation	$V_{DD}=11\text{ V to }22\text{ V}$			5	%
$f_{DT}$	Frequency Variation vs. Temperature Deviation	$T_A=-40\text{ to }+105^\circ\text{C}$			5	%
<b>Feedback Input Section</b>						
$A_V$	Input Voltage to Current-Sense Attenuation		1/4.5	1/4.0	1/3.5	V/V
$Z_{FB}$	Input Impedance		13	15	17	k $\Omega$
$V_{FB-OPEN}$	Output High Voltage	FB Pin Open	4.8	5.0	5.2	V
$V_{FB-OLP}$	FB Open-Loop Trigger Level		4.3	4.6	4.9	V
$t_{D-OLP}$	Delay Time of FB Pin Open-Loop Protection		50	57	64	ms
$V_{FB-N}$	Green-Mode Entry FB Voltage	Pin, FB Voltage ( $FB=V_{FB-N}$ ), $T_A=25^\circ\text{C}$	2.6	2.8	3.0	V
		Hopping Range	$\pm 3.7$	$\pm 4.2$	$\pm 4.7$	kHz
$V_{FB-G}$	Green-Mode Ending FB Voltage	Pin, FB Voltage ( $FB=V_{FB-G}$ )	2.1	2.3	2.5	V
		Hopping Range <sup>(5)</sup>	$\pm 1.27$	$\pm 1.45$	$\pm 1.62$	kHz
$V_{FB-SKIP}$	FB Threshold Voltage for Cycle Skipping Period Divide <sup>(5)</sup>	$(V_{FB-N}+V_{FB-G})/2$	2.35	2.55	2.75	V
$t_{SKIP-N}$	Cycle Skipping Period <sup>(5)</sup>	$V_{FB-SKIP} < V_{FB} < V_{FB-N}$	180	200	220	ms
$t_{SKIP-G}$	Cycle Skipping Period <sup>(5)</sup>	$V_{FB-G} < V_{FB} < V_{FB-SKIP}$	90	100	110	ms
$V_{FB-ZDCR}$	FB Threshold Voltage for Zero-Duty Recovery		1.9	2.1	2.3	V
$V_{FB-ZDC}$	FB Threshold Voltage for Zero-Duty		1.8	2.0	2.2	V

**Note:**

- Guaranteed by design.

Continued on the following page...

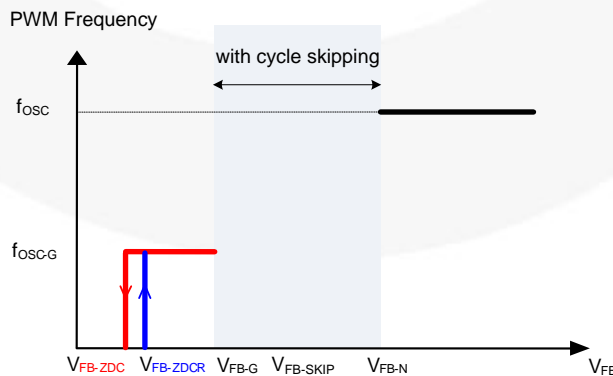

**Figure 8.  $V_{FB}$  vs. PWM Frequency**

**Electrical Characteristics** (Continued)V<sub>DD</sub>=11~24 V and T<sub>A</sub>=-40~105°C unless otherwise noted.

Symbol	Parameter	Conditions	Min.	Typ.	Max.	Unit
<b>Current-Sense Section</b>						
t <sub>PD</sub>	Delay to Output			100	250	ns
t <sub>LEB</sub>	Leading-Edge Blanking Time		210	260	310	ns
V <sub>STHFL</sub>	Flat Threshold Voltage for Current Limit	Duty>62%, FB > V <sub>FB-N</sub>	0.46	0.50	0.54	V
V <sub>STHVA</sub>	Valley Threshold Voltage for Current Limit	Duty=0%	0.31	0.34	0.37	V
V <sub>SSCP</sub>	Threshold Voltage for Sense Short-Circuit Protection		0.03	0.05	0.07	V
t <sub>ON-SSCP</sub>	On Time for V <sub>SSCP</sub> Checking		3.85	4.40	4.95	μs
t <sub>D-SSCP</sub>	Delay for Sense Short-Circuit Protection	V <sub>SENSE</sub> <0.05 V	60	120	180	μs
t <sub>SS</sub>	Soft-Start Time	Startup Time	5.5	7.5	9.5	ms
<b>GATE Section</b>						
DCY <sub>MAX</sub>	Maximum Duty Cycle		75.0	82.5	90.0	%
V <sub>GATE-L</sub>	Gate Low Voltage	V <sub>DD</sub> =15 V, I <sub>O</sub> =50 mA			1.5	V
V <sub>GATE-H</sub>	Gate High Voltage	V <sub>DD</sub> =12 V, I <sub>O</sub> =50 mA	8			V
I <sub>GATE-SINK</sub>	Gate Sink Current <sup>(5)</sup>	V <sub>DD</sub> =15 V	300			mA
I <sub>GATE-SOURCE</sub>	Gate Source Current <sup>(5)</sup>	V <sub>DD</sub> =15 V, GATE=6 V	250			mA
t <sub>r</sub>	Gate Rising Time	V <sub>DD</sub> =15 V, C <sub>L</sub> =1 nF		100		ns
t <sub>f</sub>	Gate Falling Time	V <sub>DD</sub> =15 V, C <sub>L</sub> =1 nF		50		ns
V <sub>GATE-CLAMP</sub>	Gate Output Clamping Voltage	V <sub>DD</sub> =22 V	9	13	17	V
<b>RT Section</b>						
I <sub>RT</sub>	Output Current from RT Pin		92	100	108	μA
V <sub>RTTH1</sub>	Over-Temperature Protection Threshold Voltage	0.7 V < V <sub>RT</sub> < 1.05 V, after 12 ms Latch Off	1.000	1.035	1.070	V
V <sub>RTTH2</sub>		V <sub>RT</sub> < 0.7 V, After 100 μs Latch Off	0.65	0.70	0.75	
t <sub>D-OTP1</sub>	Over-Temperature Latch-Off Debounce	V <sub>RTTH2</sub> < V <sub>RT</sub> < V <sub>RTTH1</sub> FB > V <sub>FB-N</sub>	12	16	20	ms
		V <sub>RTTH2</sub> < V <sub>RT</sub> < V <sub>RTTH1</sub> FB < V <sub>FB-G</sub>	35.5	46.5	57.5	
t <sub>D-OTP2</sub>		V <sub>RT</sub> < V <sub>RTTH2</sub> , FB > V <sub>FB-N</sub>	110	185	260	μs
		V <sub>RT</sub> < V <sub>RTTH2</sub> , FB < V <sub>FB-G</sub>	215	500	785	

**Note:**

6. Guaranteed by design.



## Typical Performance Characteristics

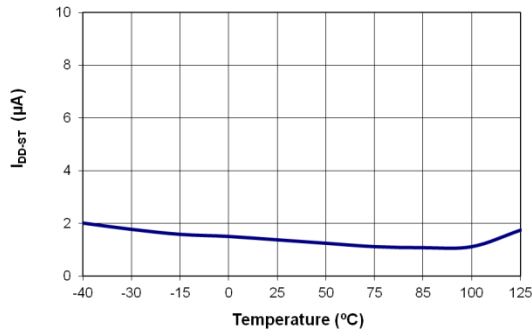

Figure 9. Startup Current ( $I_{DD-ST}$ ) vs. Temperature

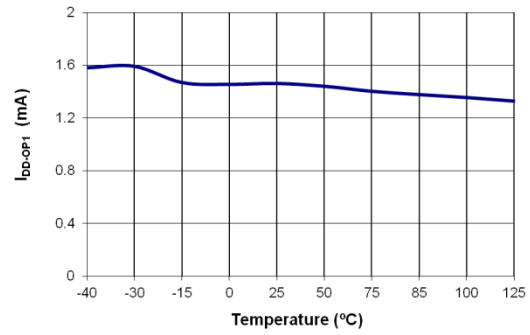

Figure 10. Operation Supply Current ( $I_{DD-OP1}$ ) vs. Temperature

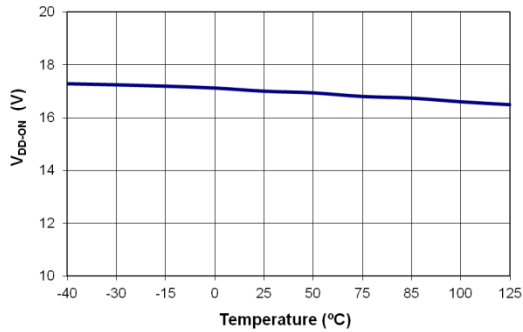

Figure 11. Start Threshold Voltage ( $V_{DD-ON}$ ) vs. Temperature

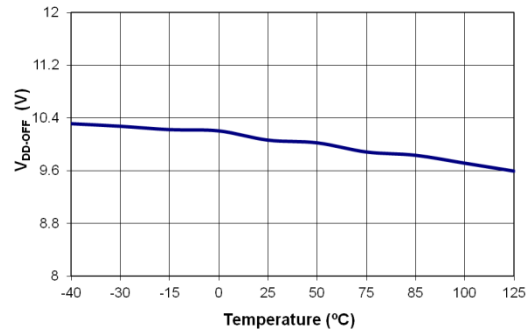

Figure 12. Minimum Operating Voltage ( $V_{DD-OFF}$ ) vs. Temperature

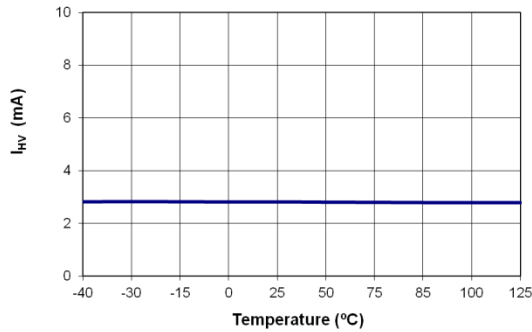

Figure 13. Supply Current Drawn from HV Pin ( $I_{HV}$ ) vs. Temperature

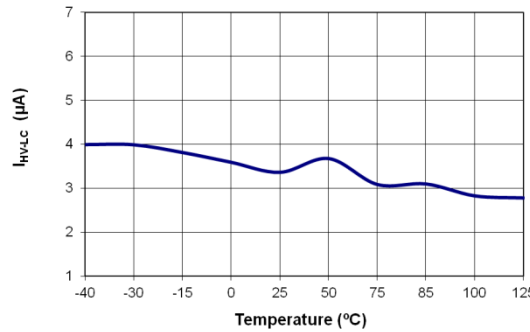

Figure 14. HV Pin Leakage Current After Startup ( $I_{HV-LC}$ ) vs. Temperature

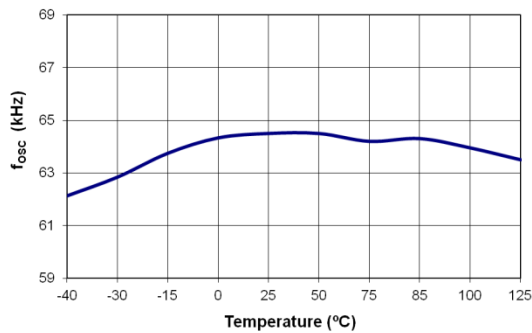

Figure 15. Frequency in Normal Mode ( $f_{osc}$ ) vs. Temperature

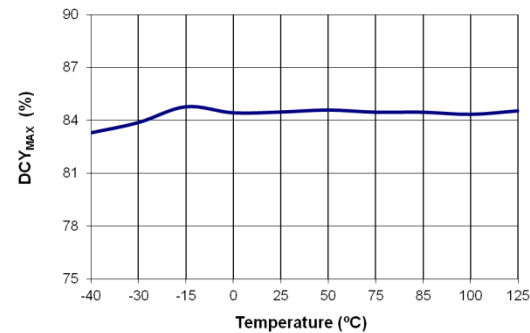
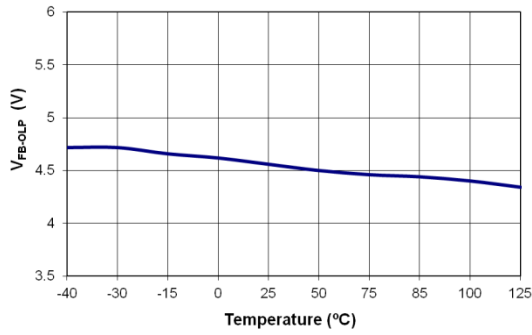
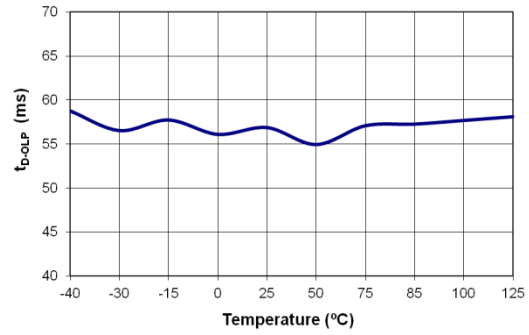

Figure 16. Maximum Duty Cycle ( $DCY_{MAX}$ ) vs. Temperature

**Typical Performance Characteristics (Continued)**



**Figure 17. FB Open-Loop Trigger Level (V<sub>FB-OLP</sub>) vs. Temperature**



**Figure 18. Delay Time of FB Pin Open-Loop Protection (t<sub>D-OLP</sub>) vs. Temperature**

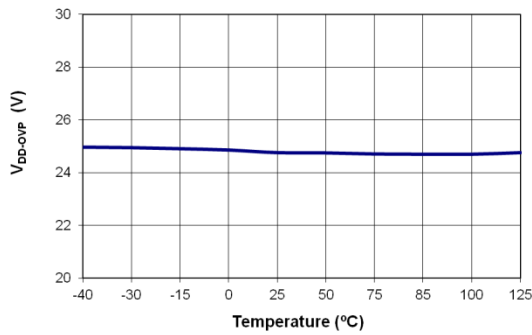

**Figure 19. V<sub>DD</sub> Over-Voltage Protection (V<sub>DD-OVP</sub>) vs. Temperature**

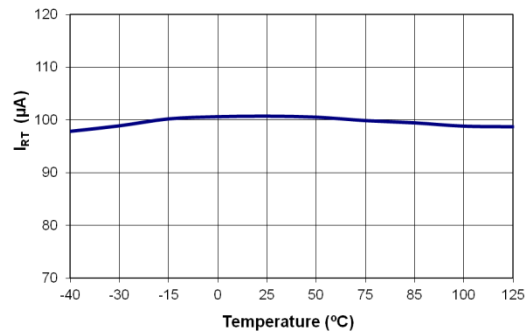

**Figure 20. Output Current from RT Pin (I<sub>RT</sub>) vs. Temperature**

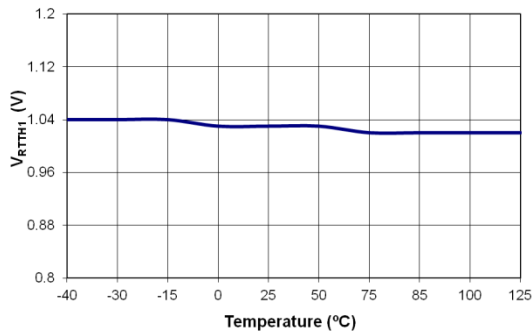

**Figure 21. Over-Temperature Protection Threshold Voltage (V<sub>RTTH1</sub>) vs. Temperature**

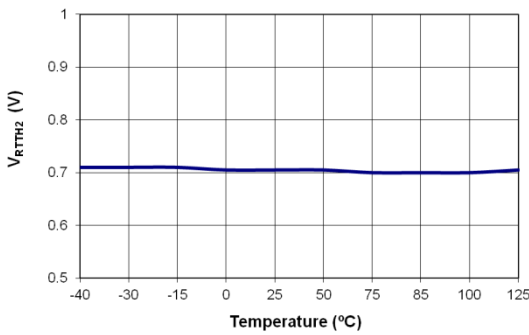

**Figure 22. Over-Temperature Protection Threshold Voltage (V<sub>RTTH2</sub>) vs. Temperature**

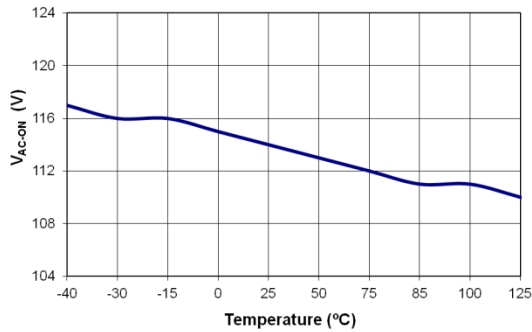

**Figure 23. Brown-In (V<sub>AC-ON</sub>) vs. Temperature**

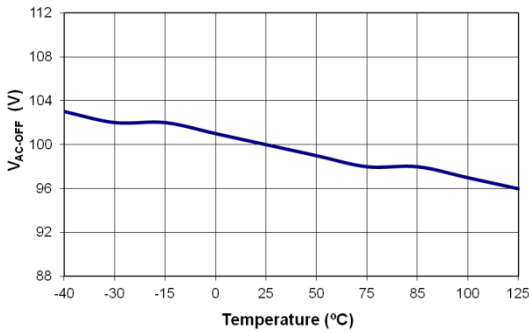

**Figure 24. Brownout (V<sub>AC-OFF</sub>) vs. Temperature**

## Functional Description

### Startup Current

For startup, the HV pin is connected to the line input through an external diode and resistor;  $R_{HV}$ , (1N4007 / 200 k $\Omega$  recommended). Peak startup current drawn from the HV pin is  $(V_{AC} \times \sqrt{2}) / R_{HV}$  and charges the hold-up capacitor through the diode and resistor. When the  $V_{DD}$  capacitor level reaches  $V_{DD-ON}$ , the startup current switches off. At this moment, the  $V_{DD}$  capacitor only supplies the FAN6604 to keep the  $V_{DD}$  until the auxiliary winding of the main transformer provides the operating current.

### Operating Current

Operating current is around 1.5 mA. The low operating current enables better efficiency and reduces the requirement of  $V_{DD}$  hold-up capacitance.

### Green-Mode Operation

The proprietary Green-Mode function provides off-time modulation to reduce the switching frequency in light-load and no-load conditions.  $V_{FB}$ , which is derived from the voltage feedback loop, is taken as the reference. Once  $V_{FB}$  is lower than the threshold voltage ( $V_{FB-N}$ ), the switching frequency is continuously decreased to the minimum Green-Mode frequency of around 22 kHz with cycle skipping.

### Current Sensing / PWM Current Limiting

Peak-current-mode control is utilized to regulate output voltage and provide pulse-by-pulse current limiting. The switch current is detected by a sense resistor into the SENSE pin. The PWM duty cycle is determined by this current-sense signal and  $V_{FB}$ , the feedback voltage. When the voltage on the SENSE pin reaches around  $V_{COMP} = (V_{FB} - 0.6) / 4$ , the switch cycle is terminated immediately.

### Leading-Edge Blanking (LEB)

Each time the power MOSFET is switched on, a turn-on spike occurs on the sense-resistor. To avoid premature termination of the switching pulse, a leading-edge blanking time is built in. During this blanking period, the current-limit comparator is disabled and cannot switch off the gate driver.

### Under-Voltage Lockout (UVLO)

The turn-on and turn-off thresholds are fixed internally at 17 V and 10 V, respectively. During startup, the hold-up capacitor must be charged to 17 V through the startup resistor to enable the IC. The hold-up capacitor continues to supply  $V_{DD}$  until the energy can be delivered from auxiliary winding of the main transformer.  $V_{DD}$  must not drop below 10 V during startup. This UVLO hysteresis window ensures that hold-up capacitor is adequate to supply  $V_{DD}$  during startup.

### Gate Output / Soft Driving

The BiCMOS output stage is a fast totem-pole gate driver. Cross conduction has been avoided to minimize heat dissipation, increase efficiency, and enhance reliability. The output driver is clamped by an internal 13 V Zener diode to protect power MOSFET transistors against undesirable gate over voltage. A soft driving waveform is implemented to minimize EMI.

### Soft-Start

For many applications, it is necessary to minimize the inrush current at startup. The built-in 8 ms soft-start circuit significantly reduces the startup current spike and output voltage overshoot.

### Slope Compensation

The sensed voltage across the current-sense resistor is used for peak-current-mode control and cycle-by-cycle current limiting. Built-in slope compensation improves stability and prevents sub-harmonic oscillation. FAN6604 inserts a synchronized, positive-going, ramp at every switching cycle.

### Constant Output Power Limit

When the SENSE voltage across sense resistor  $R_{SENSE}$  reaches the threshold voltage, the output GATE drive is turned off after a small delay,  $t_{PD}$ . This delay introduces an additional current proportional to  $t_{PD} \cdot V_{IN} / L_P$ . Since the delay is nearly constant, regardless of the input voltage  $V_{IN}$ , higher input voltage results in larger additional power. Therefore, the maximum output power at high line is higher than that of low line. To compensate this variation for a wide AC input range, a current limit uses to solve the unequal power-limit problem. The power limiter is fed to the inverting input of the current limiting comparator. This results in a lower current limit at high-line inputs than at low-line inputs.

### Brownout by the HV Pin

Unlike previous PWM controllers, the FAN6604 HV pin can detect the AC line voltage to perform brownout protection. Using a fast diode and startup resistor to sample the AC line voltage, the peak value refreshes and is stored in a register at each sampling cycle. When internal update time is met, this peak value is used for brownout and current-limit level judgment. Equation (1) and (2) calculate the level of brown-in or brownout converted to RMS value. For power saving, FAN6604 enlarges the sampling cycle to lower the power loss from HV sampling at light-load condition.

$$V_{AC-ON} (RMS) = (0.9V \times \frac{(R_{HV} + 1.6)}{1.6}) / \sqrt{2} \quad (1)$$

$$V_{AC-OFF} (RMS) = (0.81V \times \frac{(R_{HV} + 1.6)}{1.6}) / \sqrt{2} \quad (2)$$

where  $R_{HV}$  is in k $\Omega$ .

## V<sub>DD</sub> Over-Voltage Protection (OVP)

V<sub>DD</sub> over-voltage protection prevents damage due to abnormal conditions. If the V<sub>DD</sub> voltage exceeds the over-voltage protection level (V<sub>DD-OVP</sub>) and lasts for t<sub>D-VDDOVP</sub>, the PWM pulses are disabled and V<sub>DD</sub> begins to drop. As V<sub>DD</sub> drops to V<sub>DD-OLP</sub>, the internal HV startup circuit is activated and V<sub>DD</sub> is charged to V<sub>DD-ON</sub> to restart IC. Over-voltage conditions are usually caused by open feedback loops.

## Sense-Pin Short-Circuit Protection

The FAN6604 provides safety protection for Limited Power Source (LPS) tests. When the sense resistor is shorted by soldering during production, the pulse-by-pulse current limiting loses efficiency for the purpose of providing over-power protection for the unit. The unit may be damaged when the loading is larger than the maximum load. To protect against a short circuit across the current-sense resistor, the controller is designed to immediately shut down if a continuously low voltage (around 0.05 V/120 μs) on the SENSE pin is detected.

## Thermal Protection

An NTC thermistor, R<sub>NTC</sub>, in series with resistor R<sub>A</sub>, can be connected from the RT pin to ground. A constant current, I<sub>RT</sub>, is output from the RT pin. The voltage on the RT pin can be expressed as V<sub>RT</sub>=I<sub>RT</sub> • (R<sub>NTC</sub> + R<sub>PCTC</sub>), where I<sub>RT</sub> is 100 μA. At high ambient temperature, the R<sub>NTC</sub> is smaller and so that V<sub>RT</sub> decreased. When V<sub>RT</sub> is less than 1.035 V (V<sub>RTTH1</sub>), the PWM turns off after 16 ms (t<sub>D-OTP1</sub>). If V<sub>RT</sub> is less than 0.7 V (V<sub>RTTH2</sub>), the PWM turns off after 185 μs (t<sub>D-OTP2</sub>). If the RT pin is not

connected to NTC resistor for over-temperature protection, connecting a series one 100 kΩ resistor to ground to prevent from noise interference is recommended. This pin is limited by an internal clamping circuit.

## Limited Power Control

The FB voltage is pulled HIGH once the power supply cannot sustain the output load, such as during output-short or overload conditions. If the FB voltage remains higher than a built-in threshold for longer than t<sub>D-OLP</sub>, PWM output is turned off. As PWM output is turned off, V<sub>DD</sub> begins decreasing. When V<sub>DD</sub> goes below the turn-off threshold (10 V) the controller is totally shut down and V<sub>DD</sub> is continuously discharged to V<sub>DD-OLP</sub> (6.5 V) by I<sub>DD-OLP</sub> to lower the average input power. This is called two-level UVLO. V<sub>DD</sub> is cycled again. This protection feature continues as long as the overloading condition persists. This prevents the power supply from overheating due to overloading conditions.

## Noise Immunity

Noise on the current sense or control signal may cause significant pulse-width jitter, particularly in continuous-conduction mode. Slope compensation helps alleviate this problem. Good placement and layout practices should be followed. Avoiding long PCB traces and component leads, locating compensation and filter components near the FAN6604, and increasing the power MOS gate resistance improve performance.

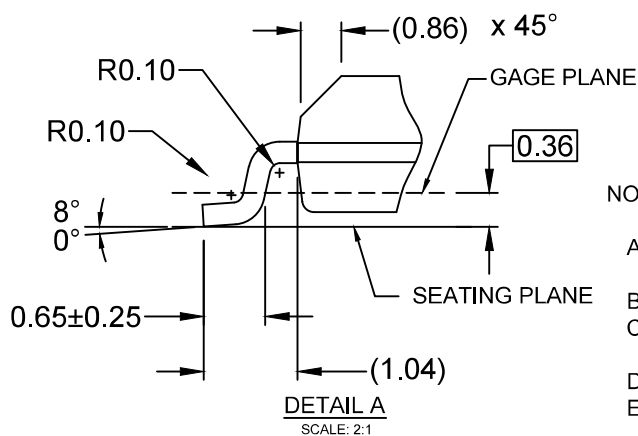
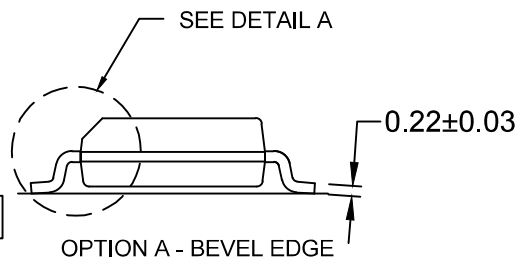
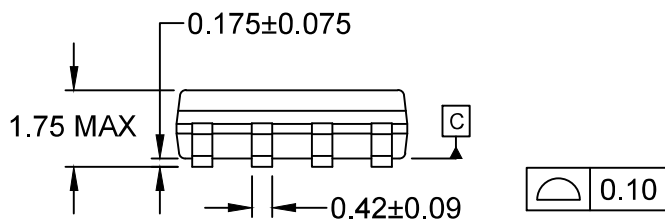
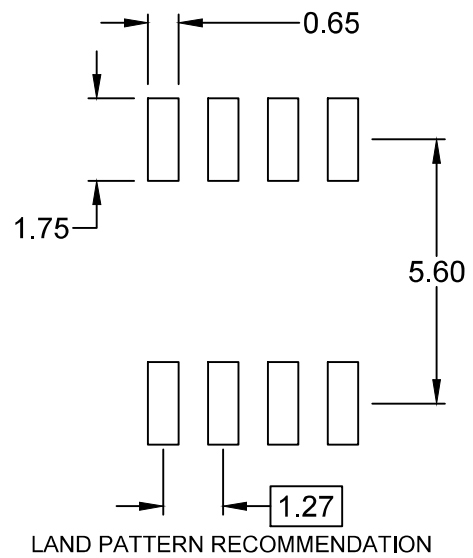
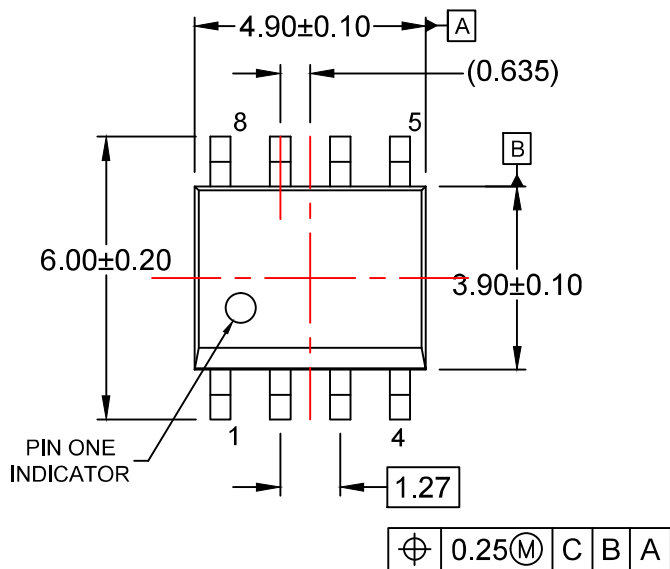

NOTES:





- A) THIS PACKAGE CONFORMS TO JEDEC MS-012, VARIATION AA.
- B) ALL DIMENSIONS ARE IN MILLIMETERS.
- C) DIMENSIONS DO NOT INCLUDE MOLD FLASH OR BURRS.
- D) LANDPATTERN STANDARD: SOIC127P600X175-8M
- E) DRAWING FILENAME: M08Arev16





### TRADEMARKS

The following includes registered and unregistered trademarks and service marks, owned by Fairchild Semiconductor and/or its global subsidiaries, and is not intended to be an exhaustive list of all such trademarks.

- |   |  |   |   |
|---|--|---|---|
| AccuPower™  | F-PFS™   | OPTOPLANAR®   |  |
| AttitudeEngine™   | FRFET®   |  | TinyBoost®  |
| Awinda®   | Global Power Resource <sup>SM</sup>            | Power Supply WebDesigner™   | TinyBuck®   |
| AX-CAP®*  | GreenBridge™                                   | PowerTrench®  | TinyCalc™   |
| BitSiC™   | Green FPS™                                     | PowerXS™  | TinyLogic®  |
| Build it Now™   | Green FPS™ e-Series™                           | Programmable Active Droop™  | TINYOPTO™   |
| CorePLUS™   | Gmax™  | QFET®   | TinyPower™  |
| CorePOWER™  | GTO™   | QS™   | TinyPWM™  |
| CROSSVOL™   | IntelliMAX™                                    | Quiet Series™   | TinyWire™   |
| CTL™  | ISOPLANAR™                                     | RapidConfigure™   | TranSiC™  |
| Current Transfer Logic™   | Making Small Speakers Sound Louder and Better™ |  | TriFault Detect™  |
| DEUXPEED®   | MegaBuck™                                      | Saving our world, 1mW/W/kW at a time™   | TRUECURRENT®*   |
| Dual Cool™  | MICROCOUPLER™                                  | SignalWise™   | μSerDes™  |
| EcoSPARK®   | MicroFET™                                      | SmartMax™   |  |
| EfficientMax™   | MicroPak™                                      | SMART START™  | UHC®  |
| ESBC™   | MicroPak2™                                     | Solutions for Your Success™   | Ultra FRFET™  |
|  | MillerDrive™                                   | SPM®  | UniFET™   |
| Fairchild®  | MotionMax™                                     | STEALTH™  | VCX™  |
| Fairchild Semiconductor®  | MotionGrid®                                    | SuperFET®   | VisualMax™  |
| FACT Quiet Series™  | MTi®   | SuperSOT™-3   | VoltagePlus™  |
| FACT®   | MTx®   | SuperSOT™-6   | XS™   |
| FastvCore™  | MVN®   | SuperSOT™-8   | Xsens™  |
| FETBench™   | mWSaver®                                       | SupreMOS®   | 仙童®   |
| FPS™  | OptoHiT™                                       | SyncFET™  |   |
|   | OPTOLOGIC®                                     | Sync-Lock™  |   |

\* Trademarks of System General Corporation, used under license by Fairchild Semiconductor.

### DISCLAIMER

FAIRCHILD SEMICONDUCTOR RESERVES THE RIGHT TO MAKE CHANGES WITHOUT FURTHER NOTICE TO ANY PRODUCTS HEREIN TO IMPROVE RELIABILITY, FUNCTION, OR DESIGN. TO OBTAIN THE LATEST, MOST UP-TO-DATE DATASHEET AND PRODUCT INFORMATION, VISIT OUR WEBSITE AT [HTTP://WWW.FAIRCHILDSEMI.COM](http://www.fairchildsemi.com). FAIRCHILD DOES NOT ASSUME ANY LIABILITY ARISING OUT OF THE APPLICATION OR USE OF ANY PRODUCT OR CIRCUIT DESCRIBED HEREIN; NEITHER DOES IT CONVEY ANY LICENSE UNDER ITS PATENT RIGHTS, NOR THE RIGHTS OF OTHERS. THESE SPECIFICATIONS DO NOT EXPAND THE TERMS OF FAIRCHILD'S WORLDWIDE TERMS AND CONDITIONS, SPECIFICALLY THE WARRANTY THEREIN, WHICH COVERS THESE PRODUCTS.

### AUTHORIZED USE

Unless otherwise specified in this data sheet, this product is a standard commercial product and is not intended for use in applications that require extraordinary levels of quality and reliability. This product may not be used in the following applications, unless specifically approved in writing by a Fairchild officer: (1) automotive or other transportation, (2) military/aerospace, (3) any safety critical application – including life critical medical equipment – where the failure of the Fairchild product reasonably would be expected to result in personal injury, death or property damage. Customer's use of this product is subject to agreement of this Authorized Use policy. In the event of an unauthorized use of Fairchild's product, Fairchild accepts no liability in the event of product failure. In other respects, this product shall be subject to Fairchild's Worldwide Terms and Conditions of Sale, unless a separate agreement has been signed by both Parties.

### ANTI-COUNTERFEITING POLICY

Fairchild Semiconductor Corporation's Anti-Counterfeiting Policy. Fairchild's Anti-Counterfeiting Policy is also stated on our external website, [www.fairchildsemi.com](http://www.fairchildsemi.com), under Terms of Use

Counterfeiting of semiconductor parts is a growing problem in the industry. All manufacturers of semiconductor products are experiencing counterfeiting of their parts. Customers who inadvertently purchase counterfeit parts experience many problems such as loss of brand reputation, substandard performance, failed applications, and increased cost of production and manufacturing delays. Fairchild is taking strong measures to protect ourselves and our customers from the proliferation of counterfeit parts. Fairchild strongly encourages customers to purchase Fairchild parts either directly from Fairchild or from Authorized Fairchild Distributors who are listed by country on our web page cited above. Products customers buy either from Fairchild directly or from Authorized Fairchild Distributors are genuine parts, have full traceability, meet Fairchild's quality standards for handling and storage and provide access to Fairchild's full range of up-to-date technical and product information. Fairchild and our Authorized Distributors will stand behind all warranties and will appropriately address any warranty issues that may arise. Fairchild will not provide any warranty coverage or other assistance for parts bought from Unauthorized Sources. Fairchild is committed to combat this global problem and encourage our customers to do their part in stopping this practice by buying direct or from authorized distributors.

### PRODUCT STATUS DEFINITIONS

#### Definition of Terms

Datasheet Identification	Product Status	Definition
Advance Information	Formative / In Design	Datasheet contains the design specifications for product development. Specifications may change in any manner without notice.
Preliminary	First Production	Datasheet contains preliminary data; supplementary data will be published at a later date. Fairchild Semiconductor reserves the right to make changes at any time without notice to improve design.
No Identification Needed	Full Production	Datasheet contains final specifications. Fairchild Semiconductor reserves the right to make changes at any time without notice to improve the design.
Obsolete	Not In Production	Datasheet contains specifications on a product that is discontinued by Fairchild Semiconductor. The datasheet is for reference information only.

Rev. I77