

# KA5x0365RN-SERIES

## KA5M0365RN, KA5L0365RN Fairchild Power Switch(FPS)

### Features

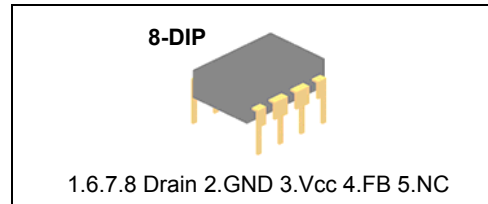
- Precision Fixed Operating Frequency (67/50kHz)
- Low Start-up Current(Typ. 100uA)
- Pulse by Pulse Current Limiting
- Over Current Protection
- Over Voltage Protection (Min. 25V)
- Internal Thermal Shutdown Function
- Under Voltage Lockout
- Internal High Voltage Sense FET
- Auto-Restart Mode

### Applications

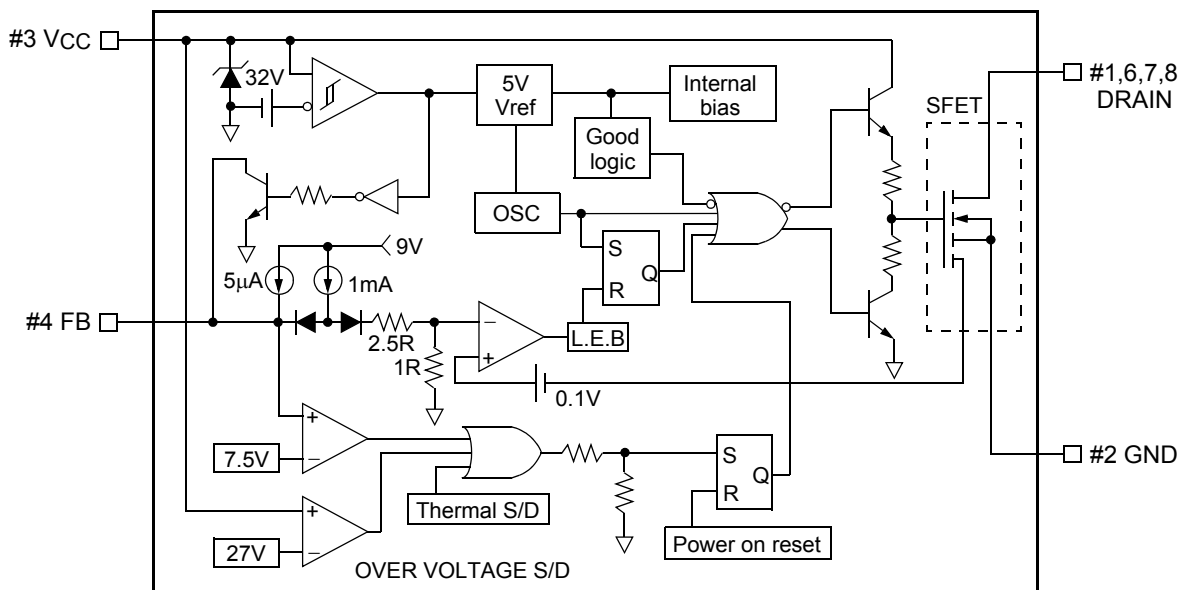
- SMPS for VCR, SVR, STB, DVD & DVCD
- SMPS for Printer, Facsimile & Scanner
- Adaptor for Camcorder

### Description

The Fairchild Power Switch(FPS) product family is specially designed for an off-line SMPS with minimal external components. The Fairchild Power Switch(FPS) consists of a high voltage power SenseFET and a current mode PWM IC. Included PWM controller integrates the fixed frequency oscillator, the under voltage lock-out, the leading edge blanking, the optimized gate turn-on/turn-off driver, the thermal shutdown protection, the over voltage protection, and the temperature compensated precision current sources for the loop compensation and the fault protection circuitry. Compared to a discrete MOSFET and a PWM controller or an RCCsolution, a Fairchild Power Switch(FPS) can reduce the total component count, design size and weight and at the same time increase efficiency, productivity, and system reliability. It has a basic platform well suited for the cost effective design in either a flyback converter or a forward converter



### Internal Block Diagram



Rev.1.0.6

## Absolute Maximum Ratings

(Ta=25°C, unless otherwise specified)

Characteristic	Symbol	Value	Unit
<b>KA5M0365RN, KA5L0365RN</b>			
Drain-Gate Voltage (R <sub>GS</sub> =1MΩ)	V <sub>DGR</sub>	650	V
Gate-Source (GND) Voltage	V <sub>GS</sub>	±30	V
Drain Current Pulsed <sup>(1)</sup>	I <sub>DM</sub>	3	ADC
Continuous Drain Current (Ta=25°C)	I <sub>D</sub>	0.42	ADC
Continuous Drain Current (Ta=100°C)	I <sub>D</sub>	0.28	ADC
Single Pulsed Avalanche Energy <sup>(2)</sup>	E <sub>AS</sub>	127	mJ
Maximum Supply Voltage	V <sub>CC,MAX</sub>	30	V
Analog Input Voltage Range	V <sub>FB</sub>	-0.3 to V <sub>SD</sub>	V
Total Power Dissipation	P <sub>D</sub>	1.56	W
	Derating	0.0125	W/°C
Operating Junction Temperature.	T <sub>J</sub>	+160	°C
Operating Ambient Temperature.	T <sub>A</sub>	-25 to +85	°C
Storage Temperature Range.	T <sub>STG</sub>	-55 to +150	°C

**Note:**

1. Repetitive rating: Pulse width limited by maximum junction temperature
2. L = 51mH, starting T<sub>J</sub> = 25°C
3. L = 13μH, starting T<sub>J</sub> = 25°C

## Electrical Characteristics (SenseFET Part)

(Ta = 25°C unless otherwise specified)

Parameter	Symbol	Condition	Min.	Typ.	Max.	Unit
<b>KA5M0365RN, KA5L0365RN</b>						
Drain-Source Breakdown Voltage	BVDSS	VGS=0V, ID=50μA	650	-	-	V
Zero Gate Voltage Drain Current	IDSS	VDS=Max. Rating, VGS=0V	-	-	50	μA
		VDS=0.8Max. Rating, VGS=0V, TC=125°C	-	-	200	μA
Static Drain-Source on Resistance <sup>(Note)</sup>	RDS(ON)	VGS=10V, ID=0.5A	-	3.6	4.5	Ω
Forward Transconductance <sup>(Note)</sup>	gfs	VDS=50V, ID=0.5A	2.0	-	-	S
Input Capacitance	Ciss	VGS=0V, VDS=25V, f=1MHz	-	314.9	-	pF
Output Capacitance	Coss		-	47	-	
Reverse Transfer Capacitance	Crss		-	9	-	
Turn On Delay Time	td(on)	VDD=0.5BVDSS, ID=1.0A (MOSFET switching time is essentially independent of operating temperature)	-	11.2	-	nS
Rise Time	tr		-	34	-	
Turn Off Delay Time	td(off)		-	28.2	-	
Fall Time	tf		-	32	-	
Total Gate Charge (Gate-Source+Gate-Drain)	Qg	VGS=10V, ID=1.0A, VDS=0.5BVDSS (MOSFET switching time is essentially independent of operating temperature)			11.93	nC
Gate-Source Charge	Qgs		-	1.95	-	
Gate-Drain (Miller) Charge	Qgd			6.85		

### Note:

1. Pulse test: Pulse width ≤ 300μS, duty ≤ 2%

2.  $S = \frac{1}{R}$

**Electrical Characteristics (Control Part)** (Continued)

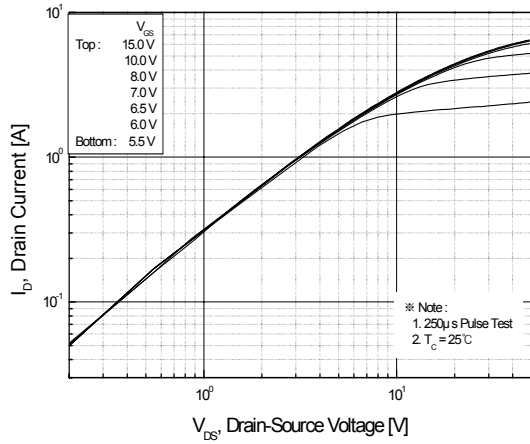
(Ta = 25°C unless otherwise specified)

Characteristic	Symbol	Test condition	Min.	Typ.	Max.	Unit
<b>UVLO SECTION</b>						
Start Threshold Voltage	VSTART	VFB=GND	14	15	16	V
Stop Threshold Voltage	VSTOP	VFB=GND	8.4	9	9.6	V
<b>OSCILLATOR SECTION</b>						
Initial Accuracy	FOSC	KA5M0365RN	61	67	73	kHz
Initial Accuracy	FOSC	KA5L0365RN	45	50	55	kHz
Frequency Change With Temperature <sup>(2)</sup>	-	-25°C≤Ta≤+85°C	-	±5	±10	%
Maximum Duty Cycle	Dmax		72	77	82	%
<b>FEEDBACK SECTION</b>						
Feedback Source Current	IFB	Ta=25°C, 0V≤Vfb≤3V	0.7	0.9	1.1	mA
Shutdown Feedback Voltage	VSD	Vfb≥6.5V	6.9	7.5	8.1	V
Shutdown Delay Current	Idelay	Ta=25°C, 5V≤Vfb≤VSD	4	5	6	μA
<b>REFERENCE SECTION</b>						
Output Voltage <sup>(1)</sup>	Vref	Ta=25°C	4.80	5.00	5.20	V
Temperature Stability <sup>(1)(2)</sup>	Vref/ΔT	-25°C≤Ta≤+85°C	-	0.3	0.6	mV/°C
<b>CURRENT LIMIT(SELF-PROTECTION)SECTION</b>						
Peak Current Limit	I <sub>OVER</sub>	Max. inductor current	1.89	2.15	2.41	A
<b>PROTECTION SECTION</b>						
Over Voltage Protection	VOVP	VCC≥24V	25	27	29	V
Thermal Shutdown Temperature (Tj) <sup>(1)</sup>	TSD	-	140	160	-	°C
<b>TOTAL STANDBY CURRENT SECTION</b>						
Start-up Current	I <sub>START</sub>	VCC=14V	-	100	170	μA
Operating Supply Current (Control Part Only)	I <sub>OP</sub>	VCC≤28	-	7	12	mA

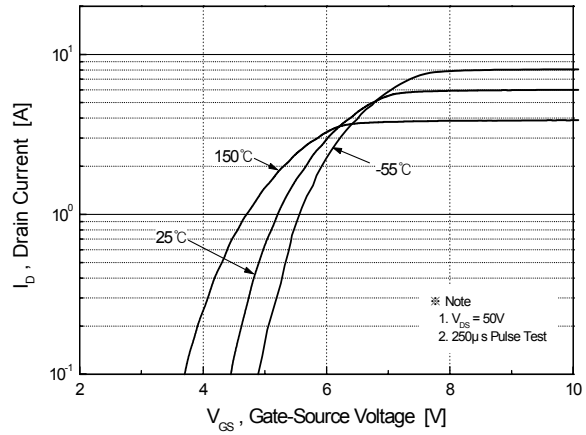
**Note:**

1. These parameters, although guaranteed, are not 100% tested in production
2. These parameters, although guaranteed, are tested in EDS(water test) process

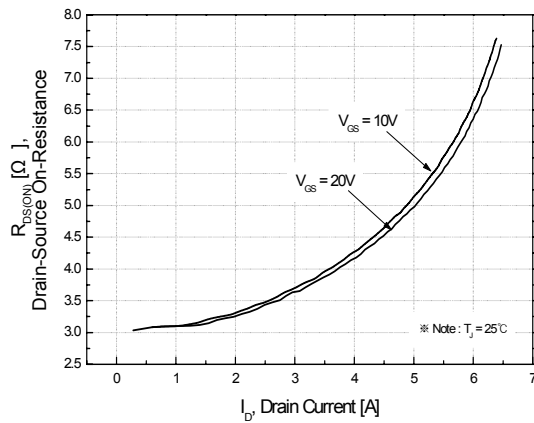
**Typical Performance Characteristics(SenseFET part)** (Continued)  
**(KA5M0365RN, KA5L0365RN)**



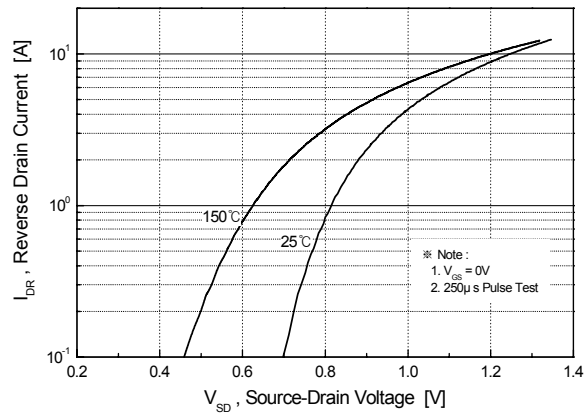
**Figure 1. Output Characteristics**



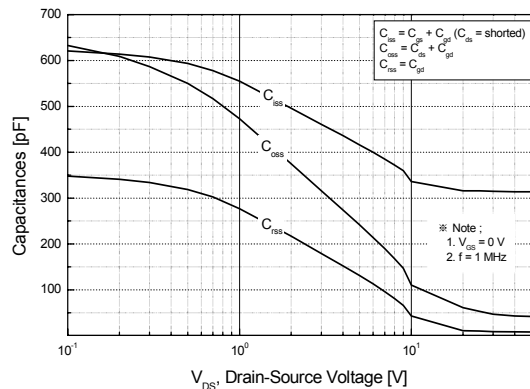
**Figure 2. Transfer Characteristics**



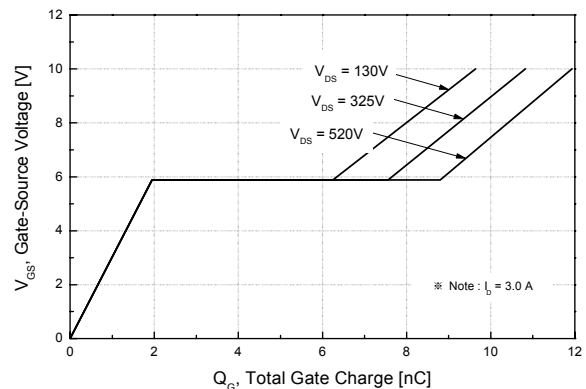
**Figure 3. On-Resistance vs. Drain Current**



**Figure 4. Source-Drain Diode Forward Voltage**

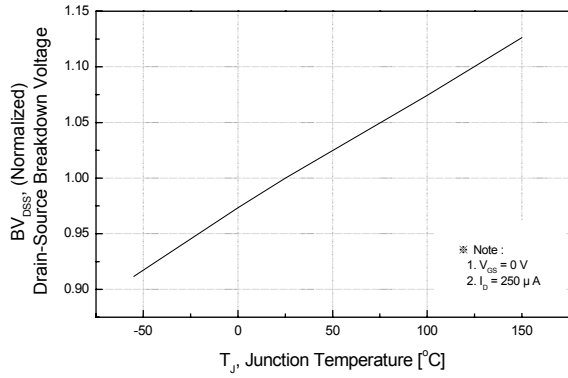


**Figure 5. Capacitance vs. Drain-Source Voltage**

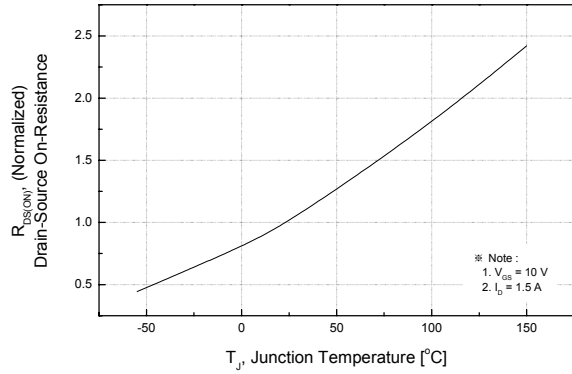


**Figure 6. Gate Charge vs. Gate-Source Voltage**

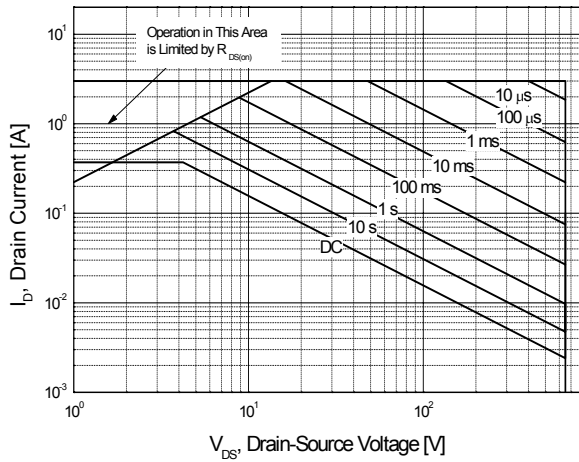
**Typical Performance Characteristics** (Continued)  
 ( KA5M0365RN, KA5L0365RN)



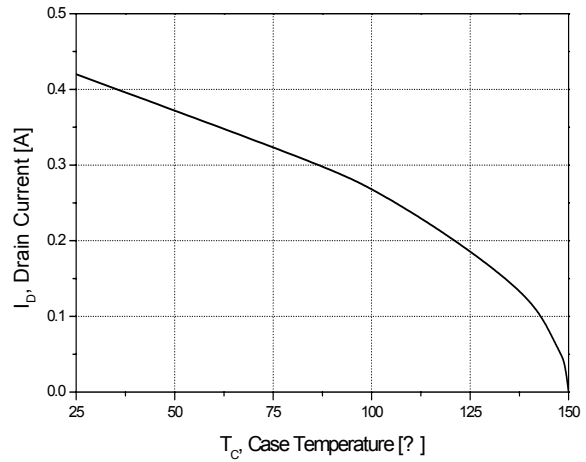
**Figure 7. Breakdown Voltage vs. Temperature**



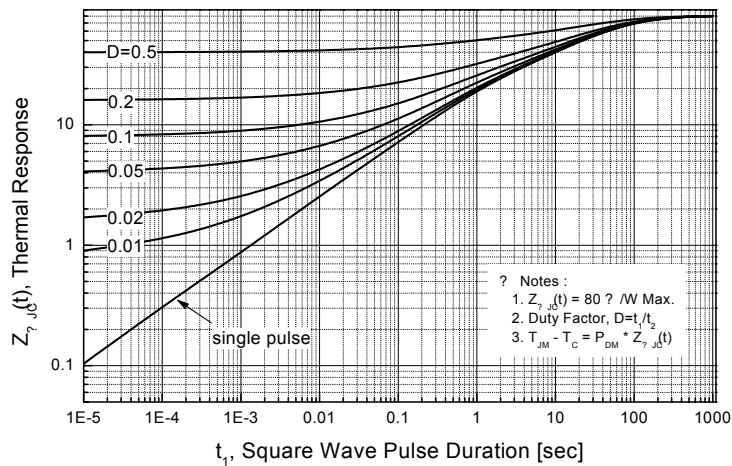
**Figure 8. On-Resistance vs. Temperature**



**Figure 9. Max. Safe Operating Area**



**Figure 10. Max. Drain Current vs. Case Temperature**



**Figure 11. Thermal Response**

## Typical Performance Characteristics (Control Part) (Continued)

(These characteristic graphs are normalized at  $T_a = 25^\circ\text{C}$ )

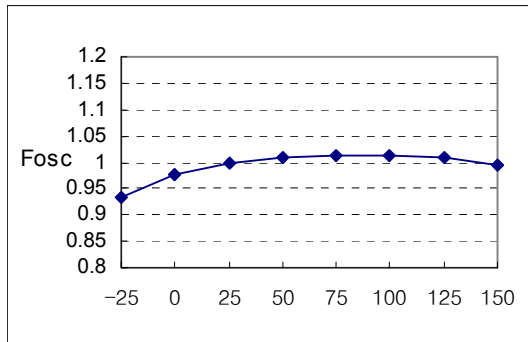


Figure 1. Operating Frequency

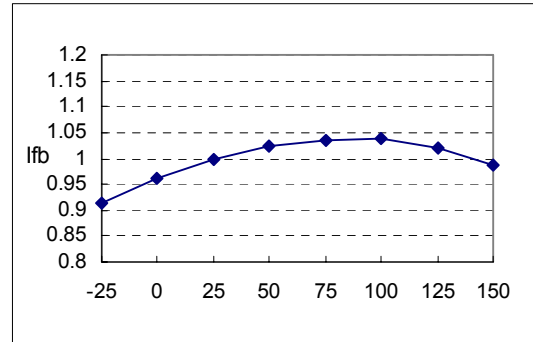


Figure 2. Feedback Source Current

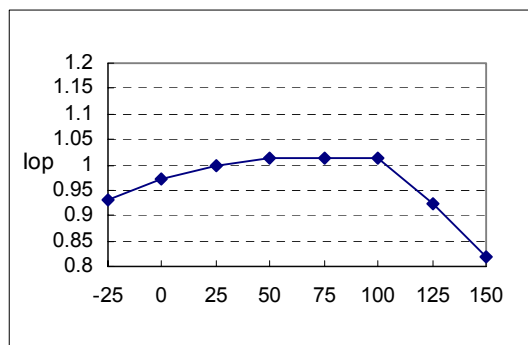


Figure 3. Operating Supply Current

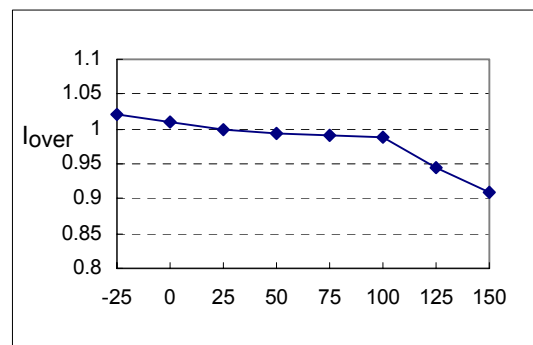


Figure 4. Peak Current Limit

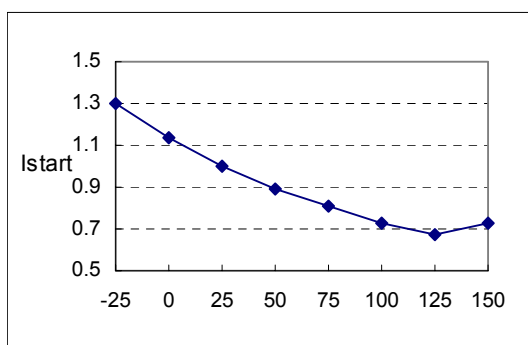


Figure 5. Start up Current

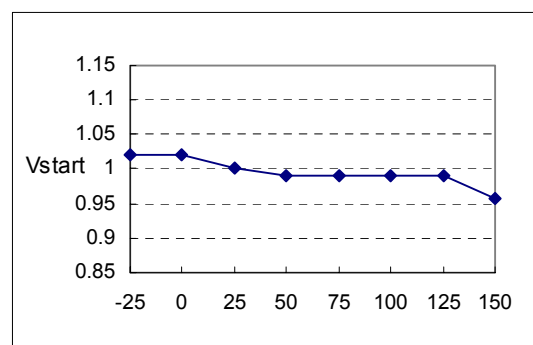


Figure 6. Start Threshold Voltage

**Typical Performance Characteristics** (Continued)

(These characteristic graphs are normalized at  $T_a = 25^\circ\text{C}$ )

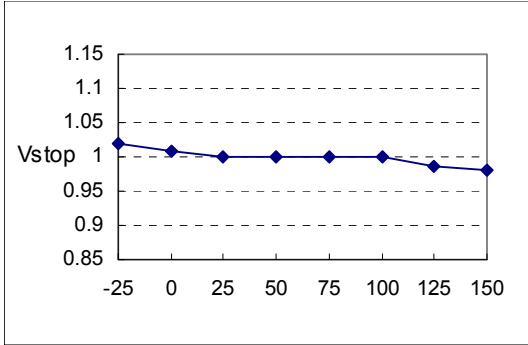


Figure 7. Stop Threshold Voltage

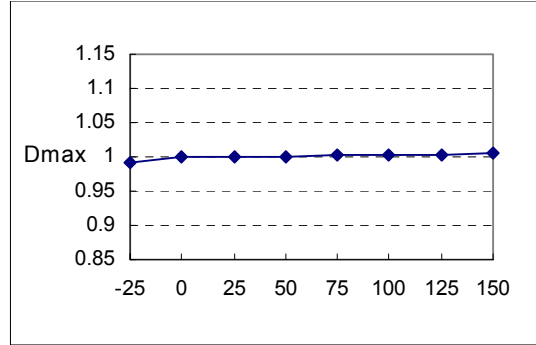


Figure 8. Maximum Duty Cycle

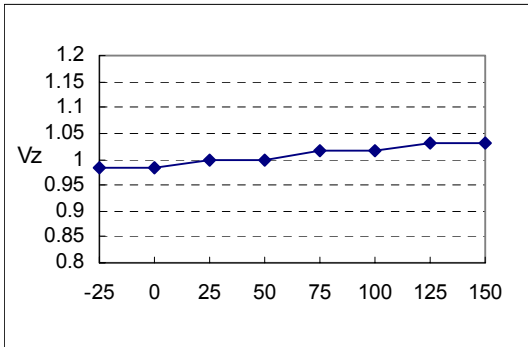


Figure 9. VCC Zener Voltage

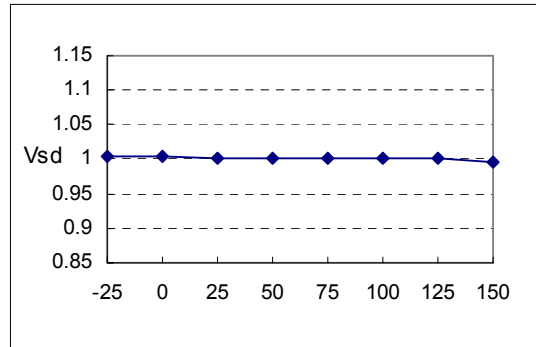


Figure 10. Shutdown Feedback Voltage

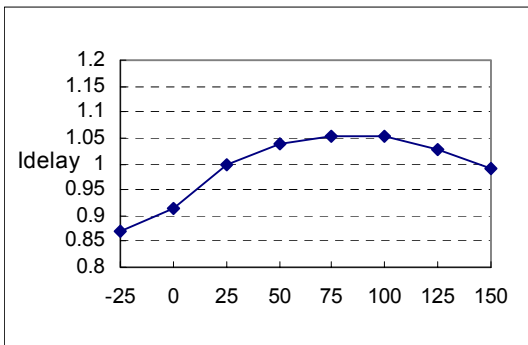


Figure 11. Shutdown Delay Current

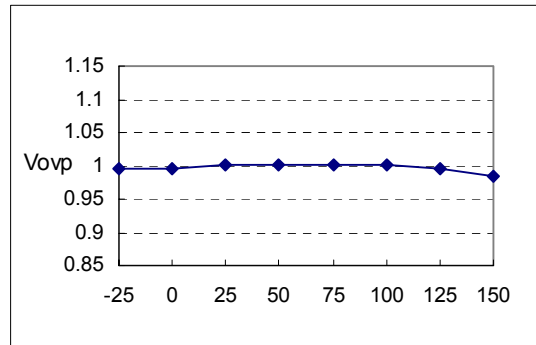


Figure 12. Over Voltage Protection



**Typical Performance Characteristics** (Continued)

(These characteristic graphs are normalized at  $T_a = 25^\circ\text{C}$ )

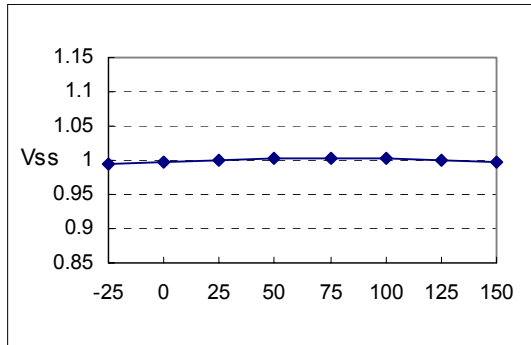


Figure 13. Soft Start Voltage

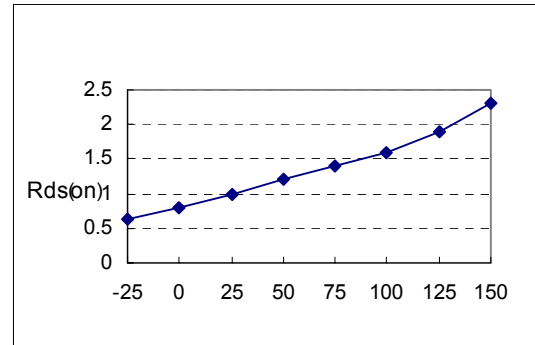
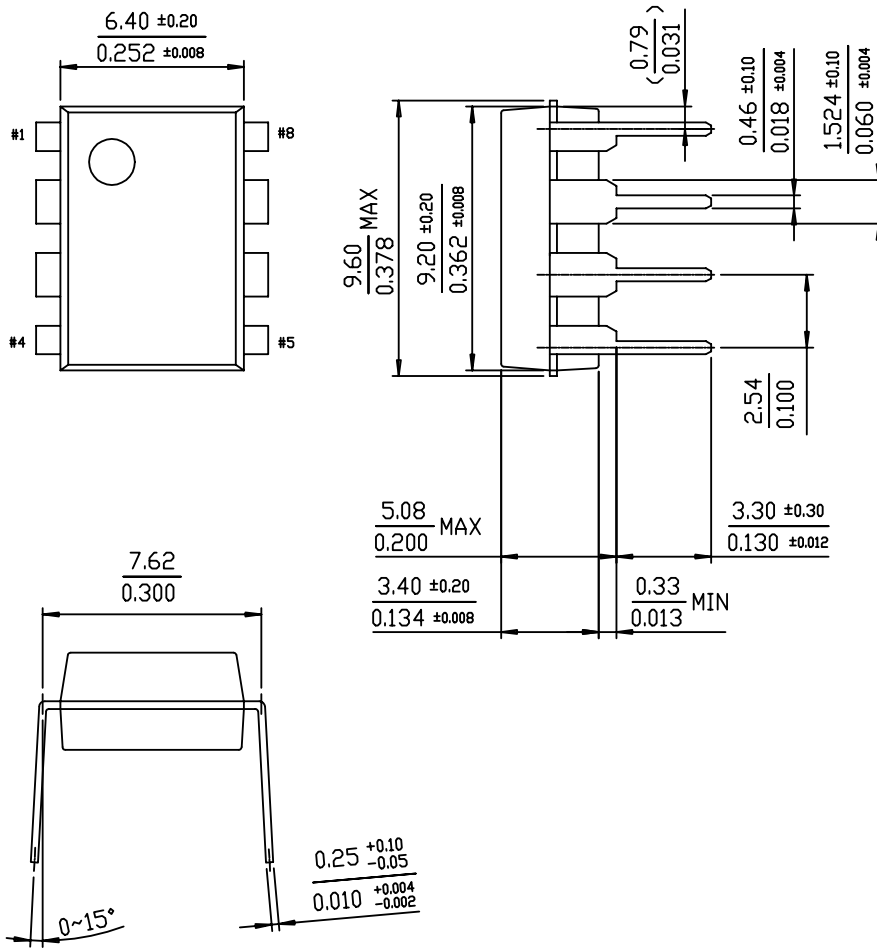


Figure 14. Static Drain-Source on Resistance

Package Dimensions

8-DIP



---

**Ordering Information**

Product Number	Package	Marking Code	BVDSS	FOSC	RDS(on)
KA5M0365RN	8-DIP	5M0365R	650V	67kHz	3.6Ω
KA5L0365RN	8-DIP	5L0365R	650V	50kHz	3.6Ω

**DISCLAIMER**

FAIRCHILD SEMICONDUCTOR RESERVES THE RIGHT TO MAKE CHANGES WITHOUT FURTHER NOTICE TO ANY PRODUCTS HEREIN TO IMPROVE RELIABILITY, FUNCTION OR DESIGN. FAIRCHILD DOES NOT ASSUME ANY LIABILITY ARISING OUT OF THE APPLICATION OR USE OF ANY PRODUCT OR CIRCUIT DESCRIBED HEREIN; NEITHER DOES IT CONVEY ANY LICENSE UNDER ITS PATENT RIGHTS, NOR THE RIGHTS OF OTHERS.

**LIFE SUPPORT POLICY**

FAIRCHILD'S PRODUCTS ARE NOT AUTHORIZED FOR USE AS CRITICAL COMPONENTS IN LIFE SUPPORT DEVICES OR SYSTEMS WITHOUT THE EXPRESS WRITTEN APPROVAL OF THE PRESIDENT OF FAIRCHILD SEMICONDUCTOR CORPORATION. As used herein:

1. Life support devices or systems are devices or systems which, (a) are intended for surgical implant into the body, or (b) support or sustain life, and (c) whose failure to perform when properly used in accordance with instructions for use provided in the labeling, can be reasonably expected to result in a significant injury of the user.
2. A critical component in any component of a life support device or system whose failure to perform can be reasonably expected to cause the failure of the life support device or system, or to affect its safety or effectiveness.